

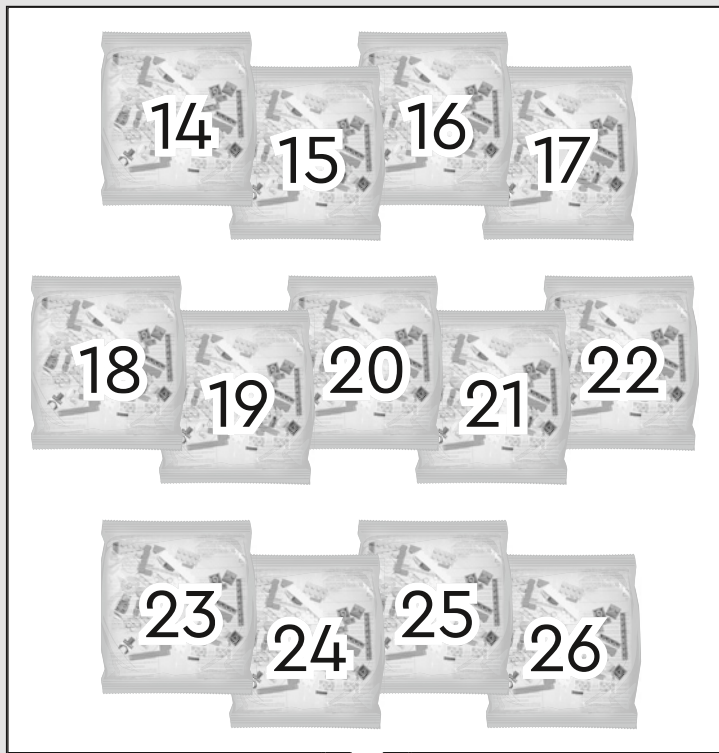

2

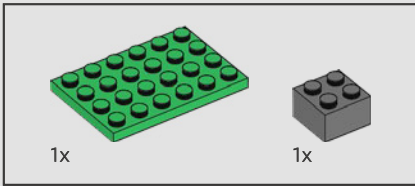

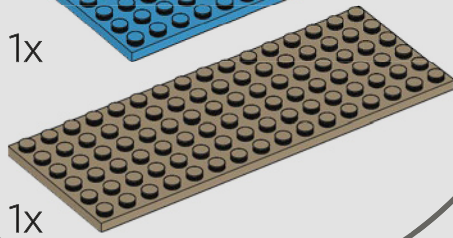

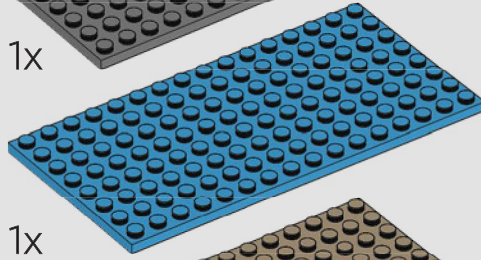
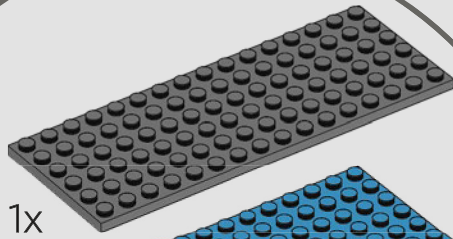
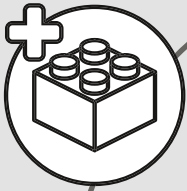

260

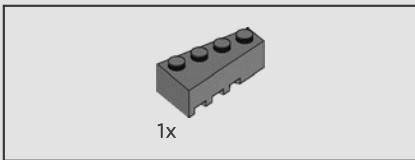
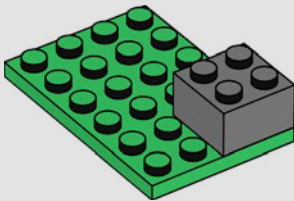

261

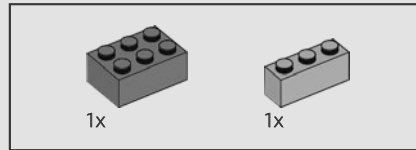
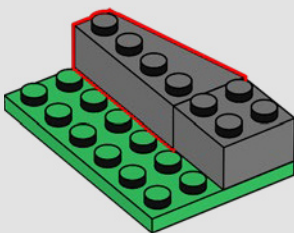

262

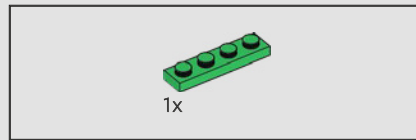
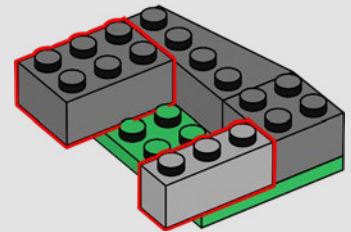

263

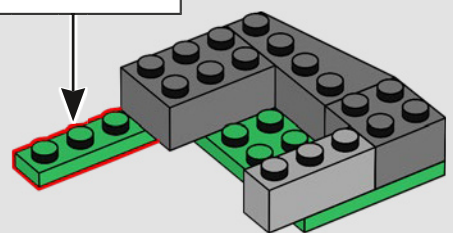
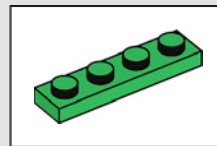

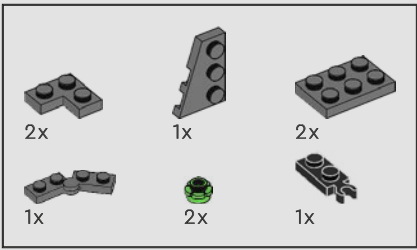

264

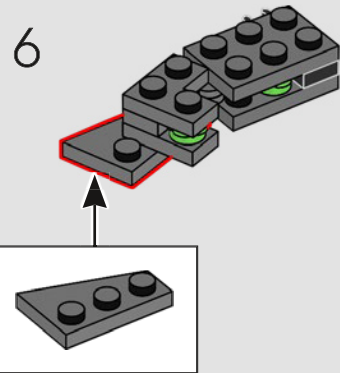
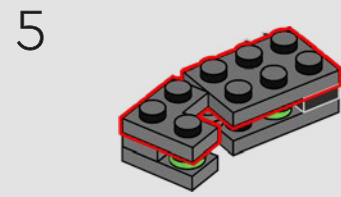
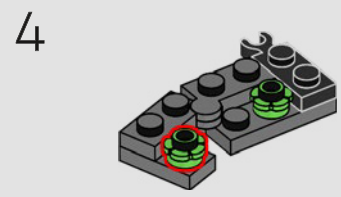
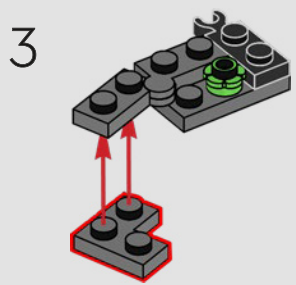
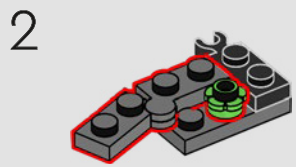
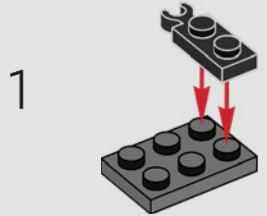

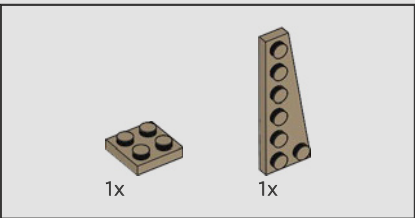

265

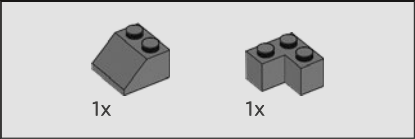
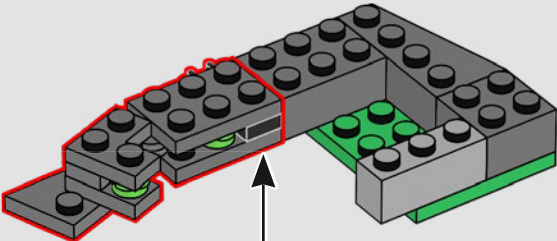
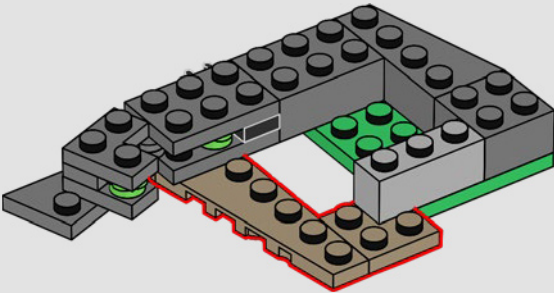

266

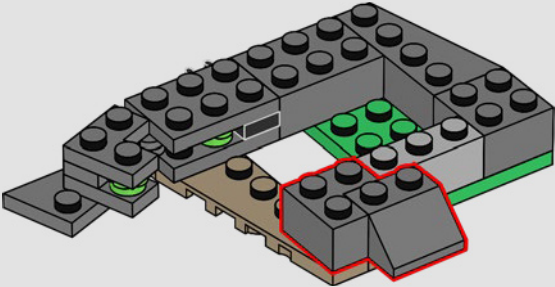

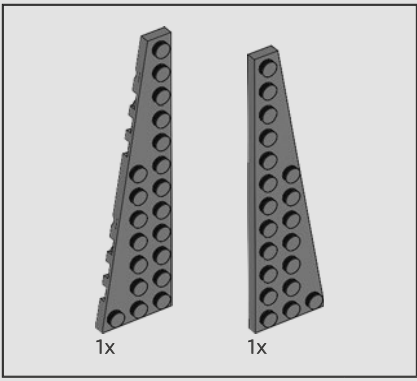

267

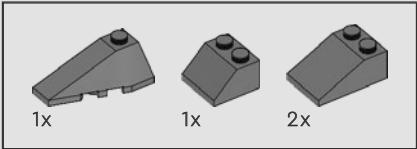
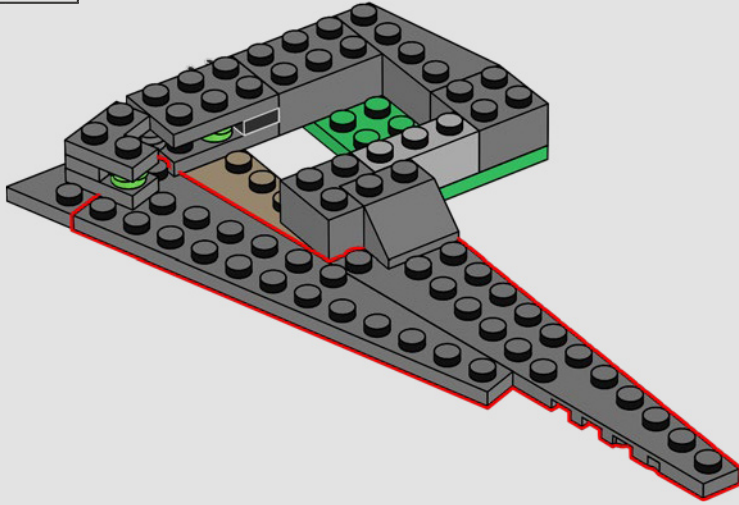

268

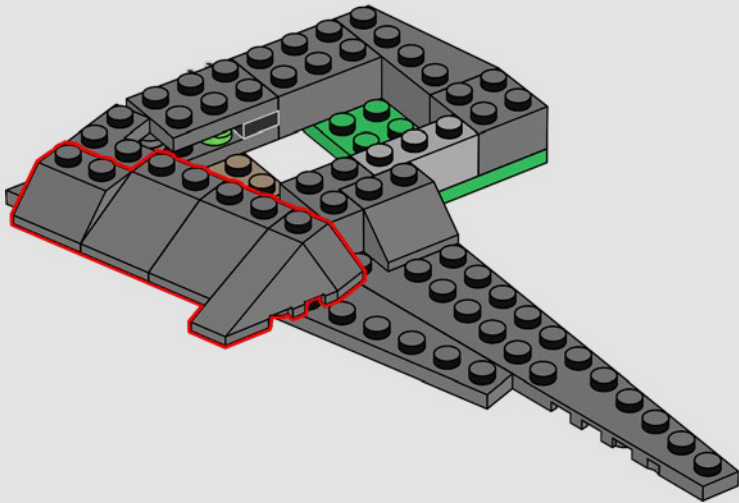

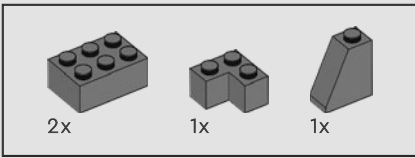

269

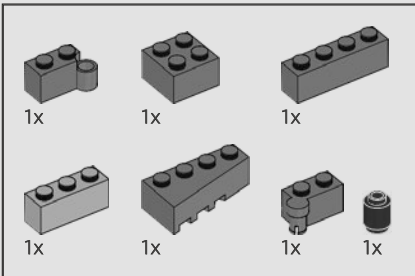
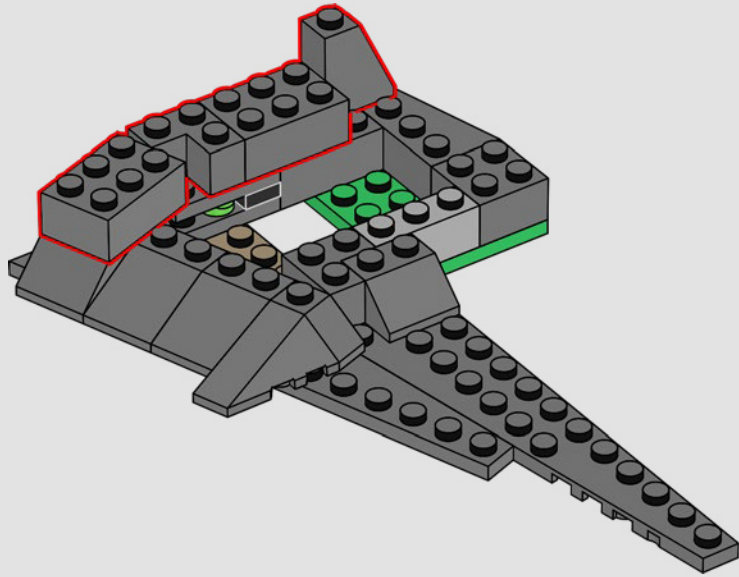

270

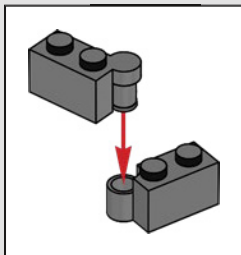
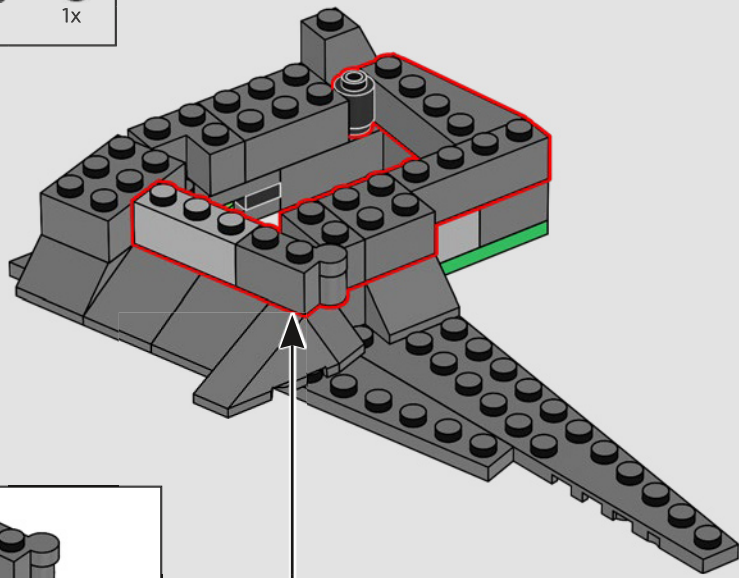

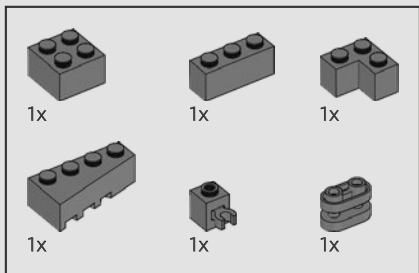

271

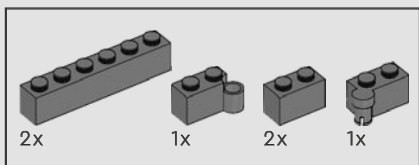
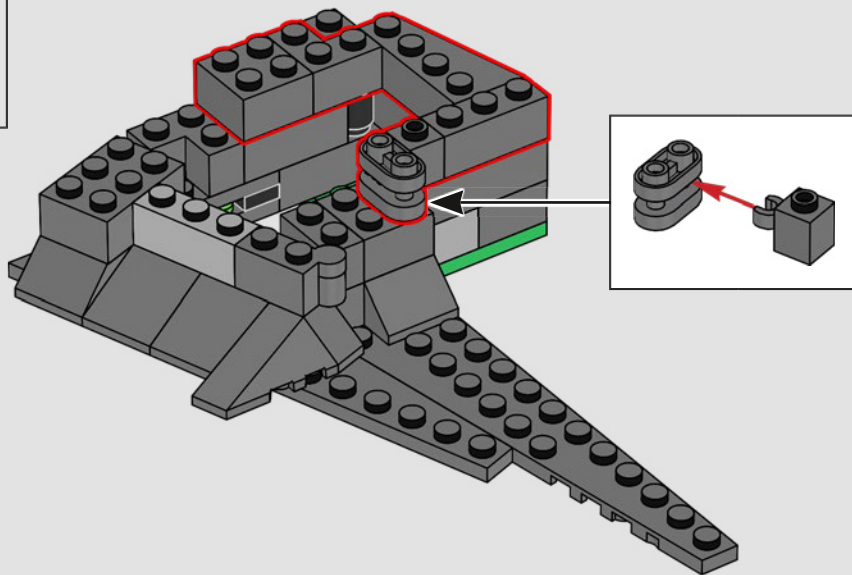

272

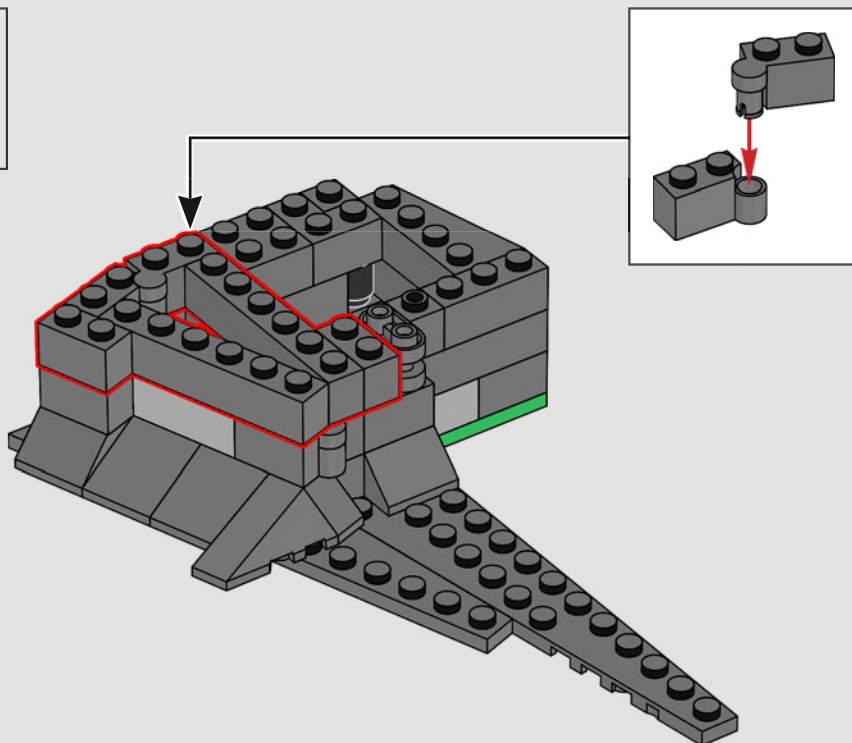

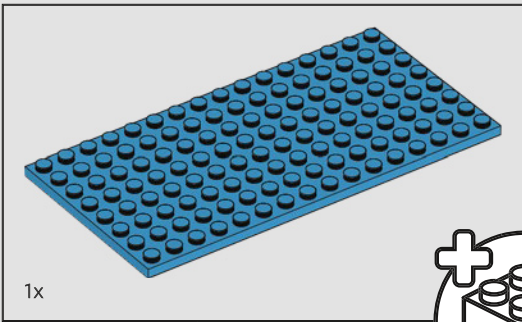

1x

273

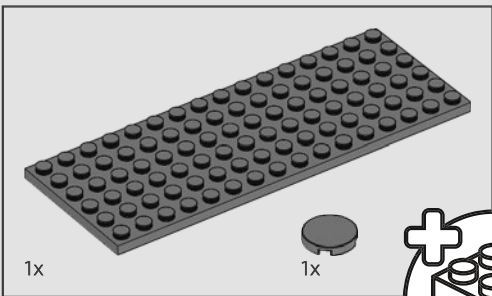
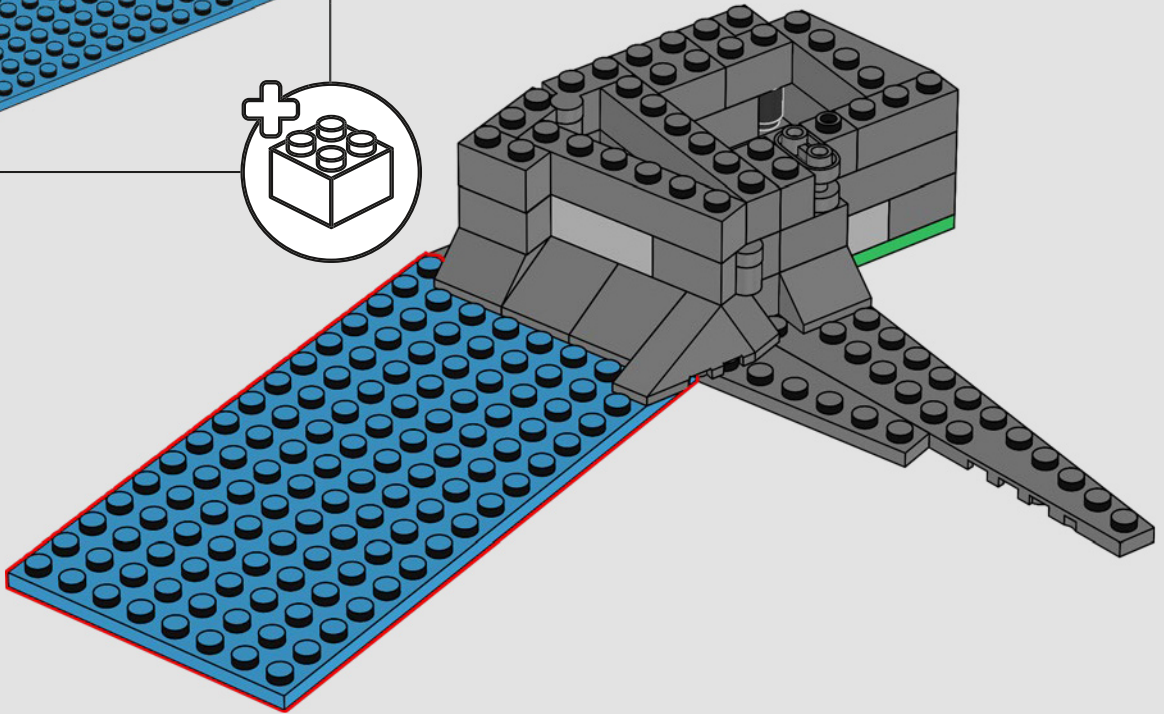
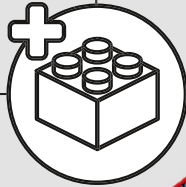

1x

1x

274

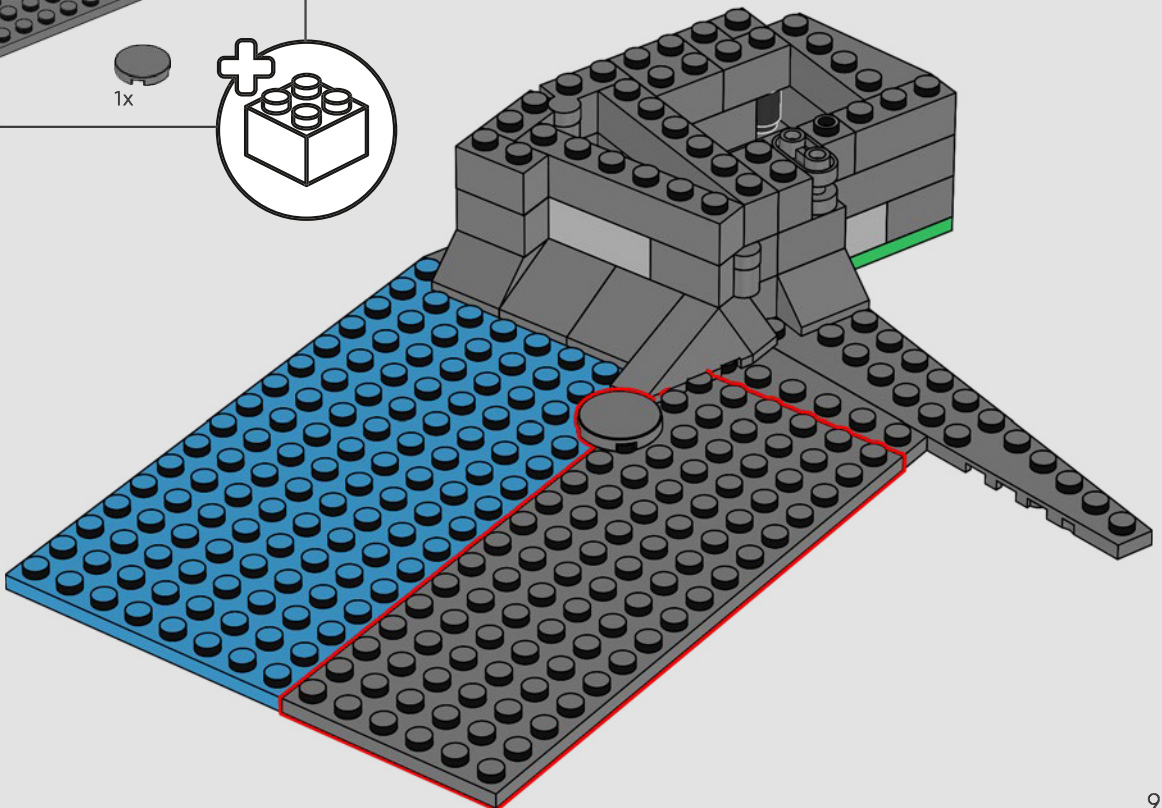
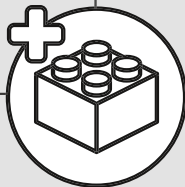

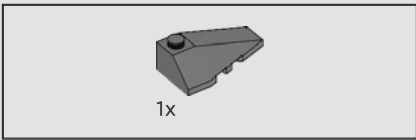

275

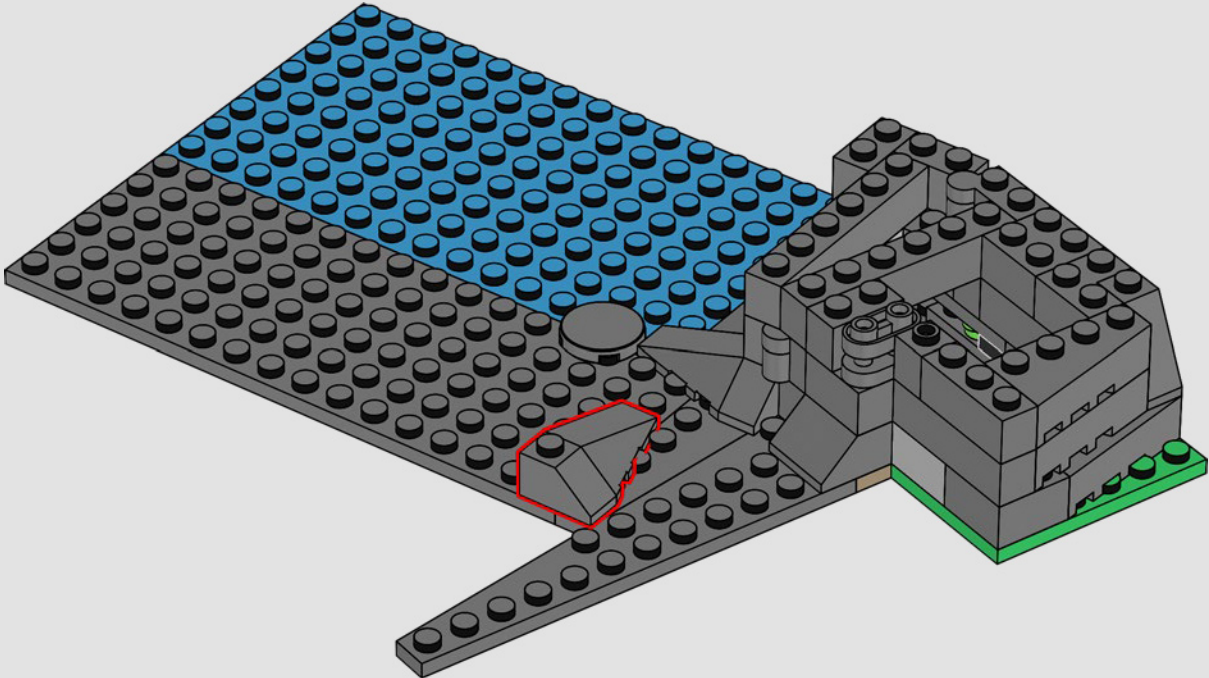

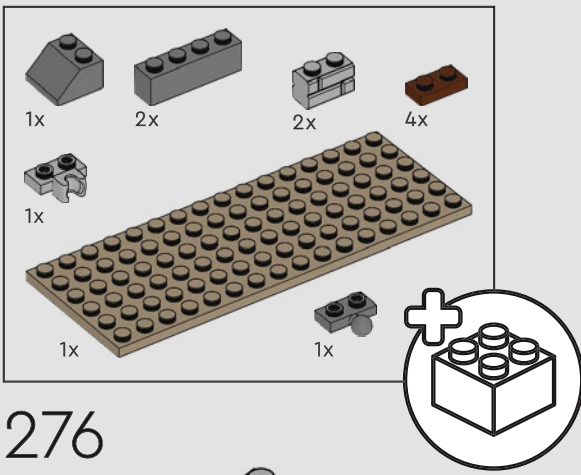

276

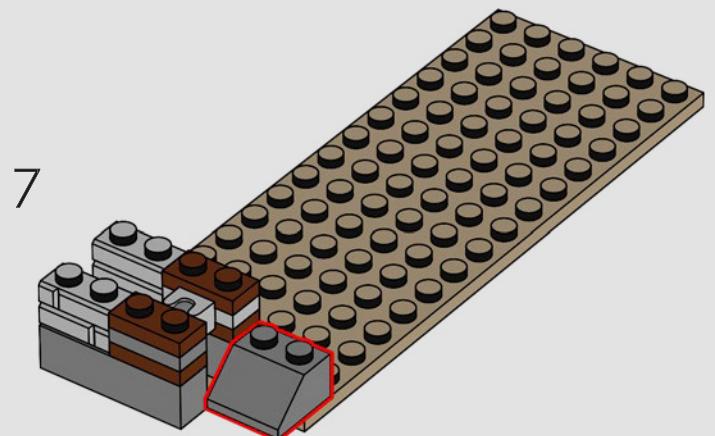
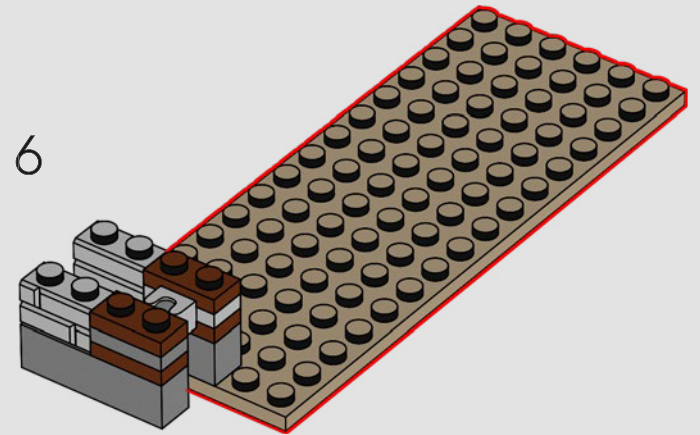
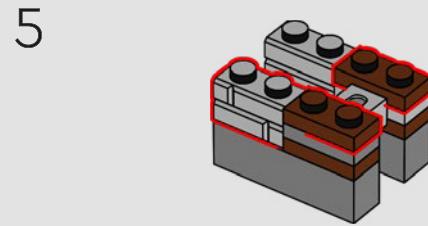
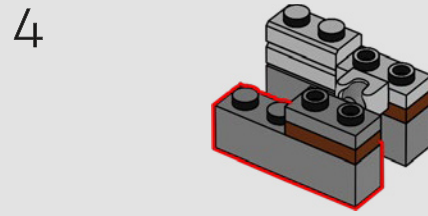
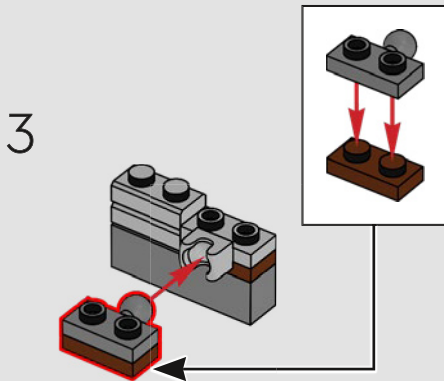
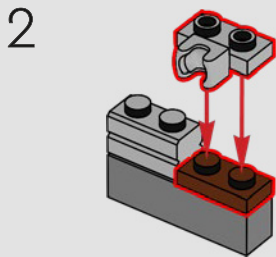
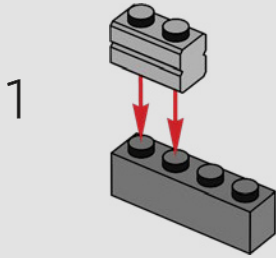

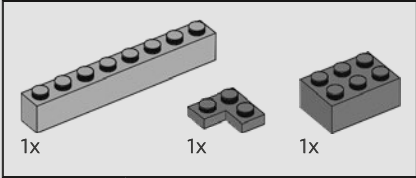
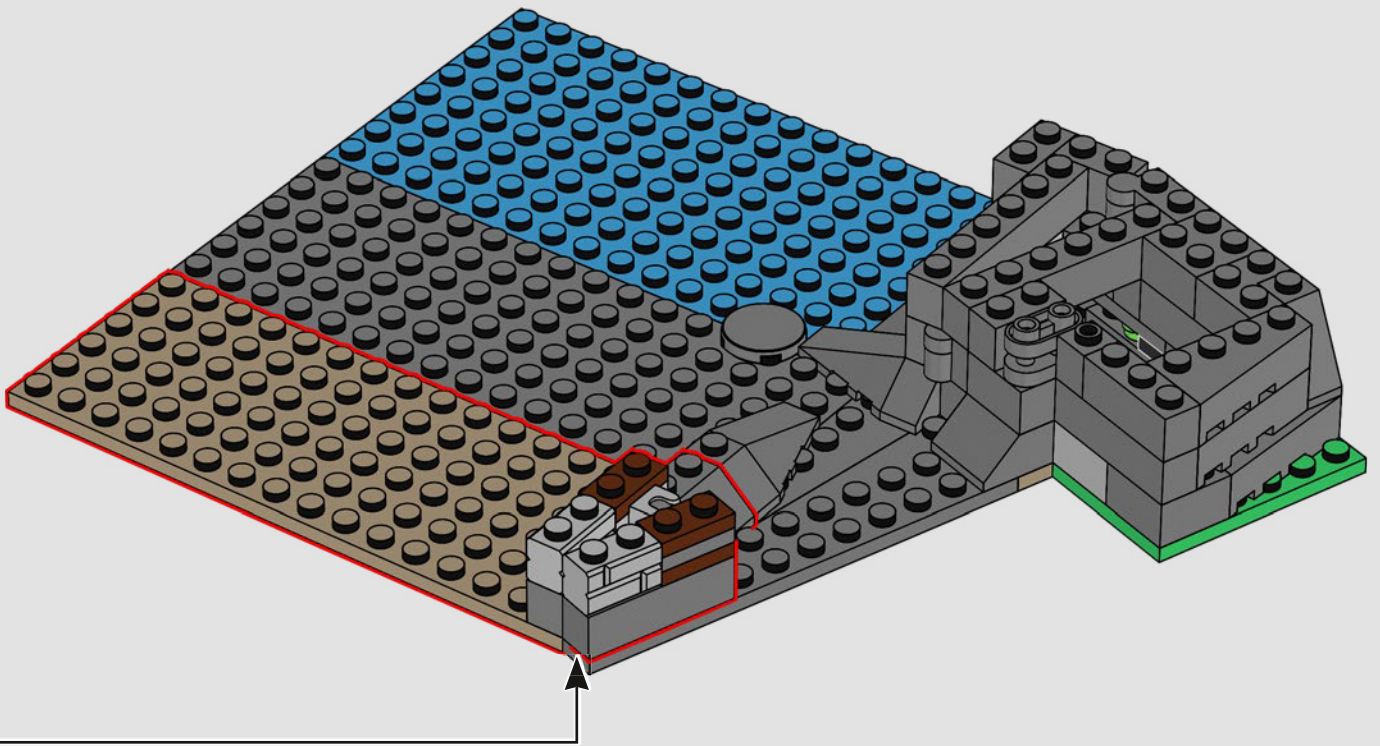

277

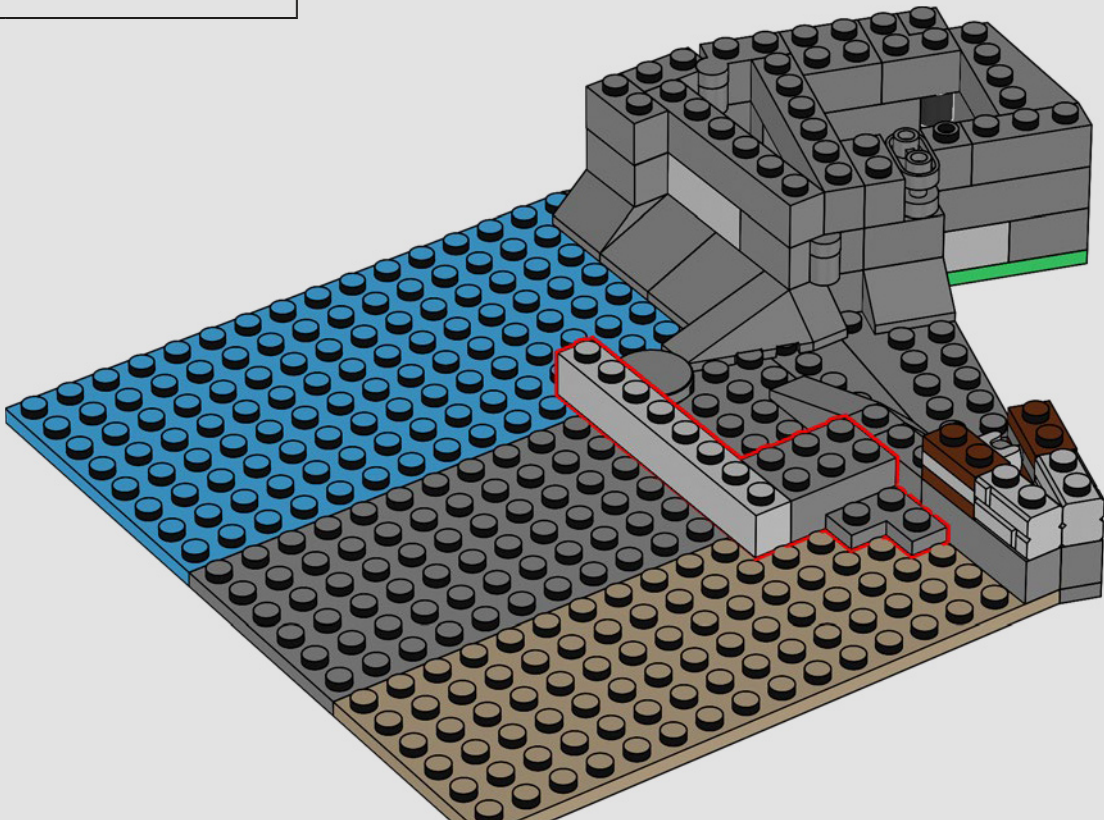

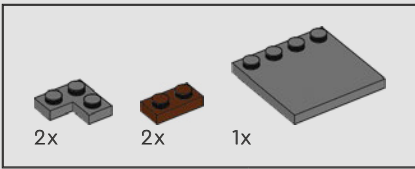

278

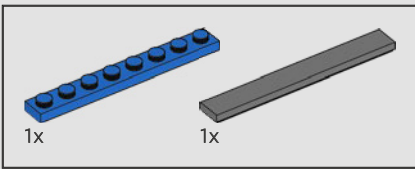
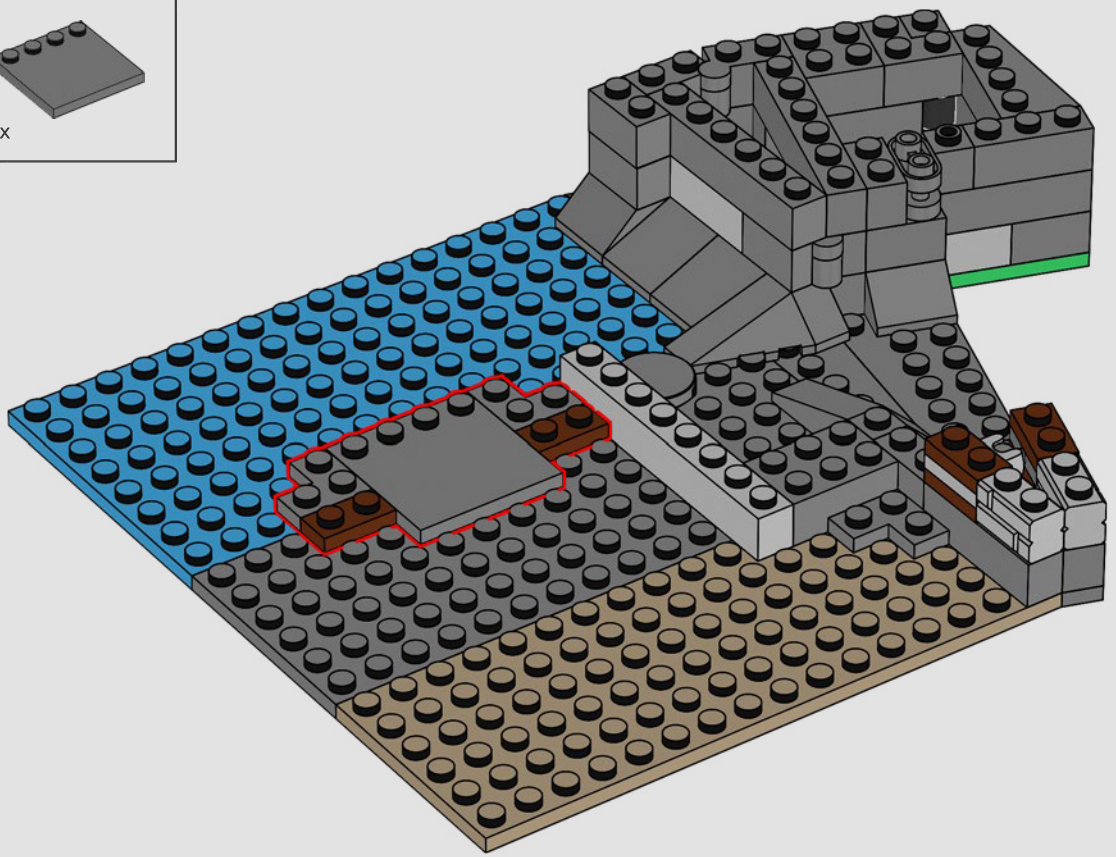

279

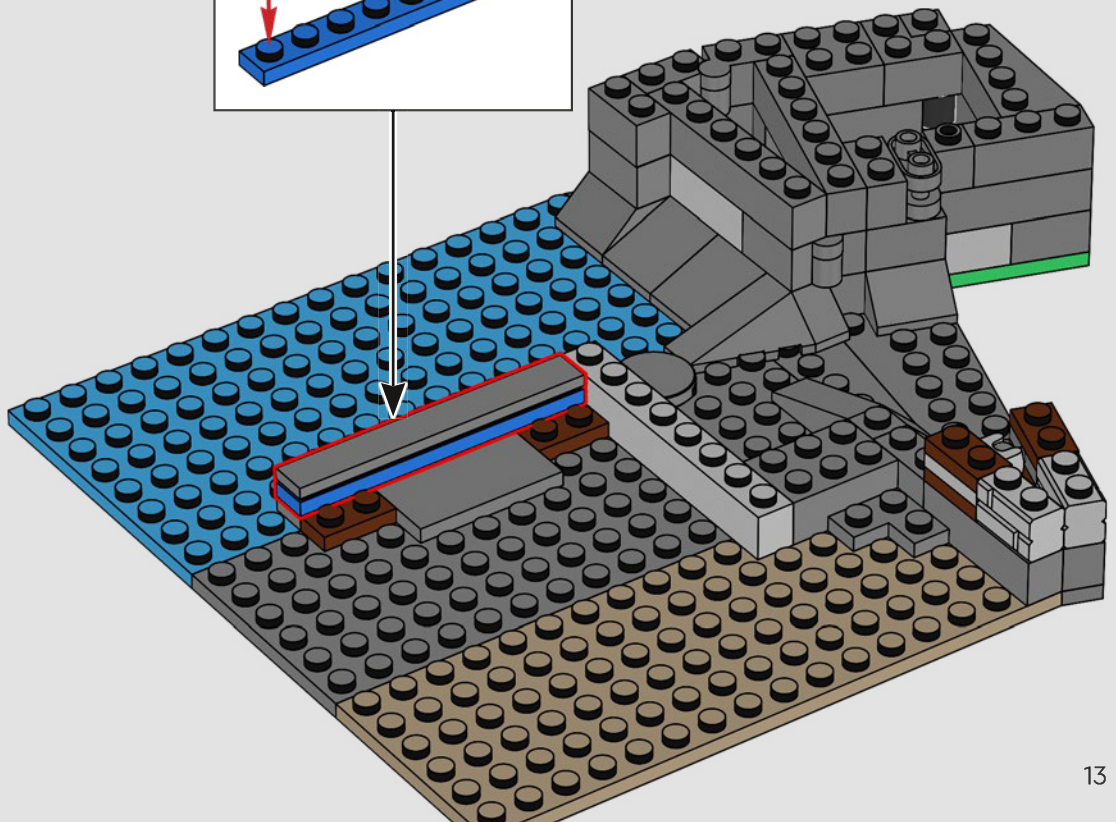
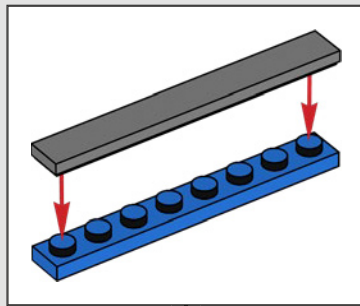

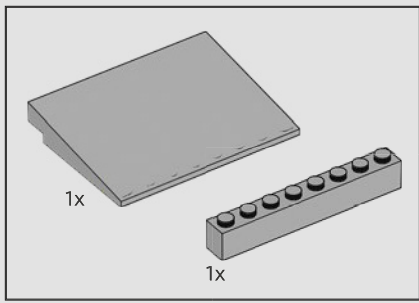

280

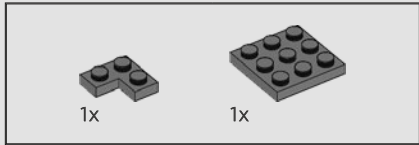
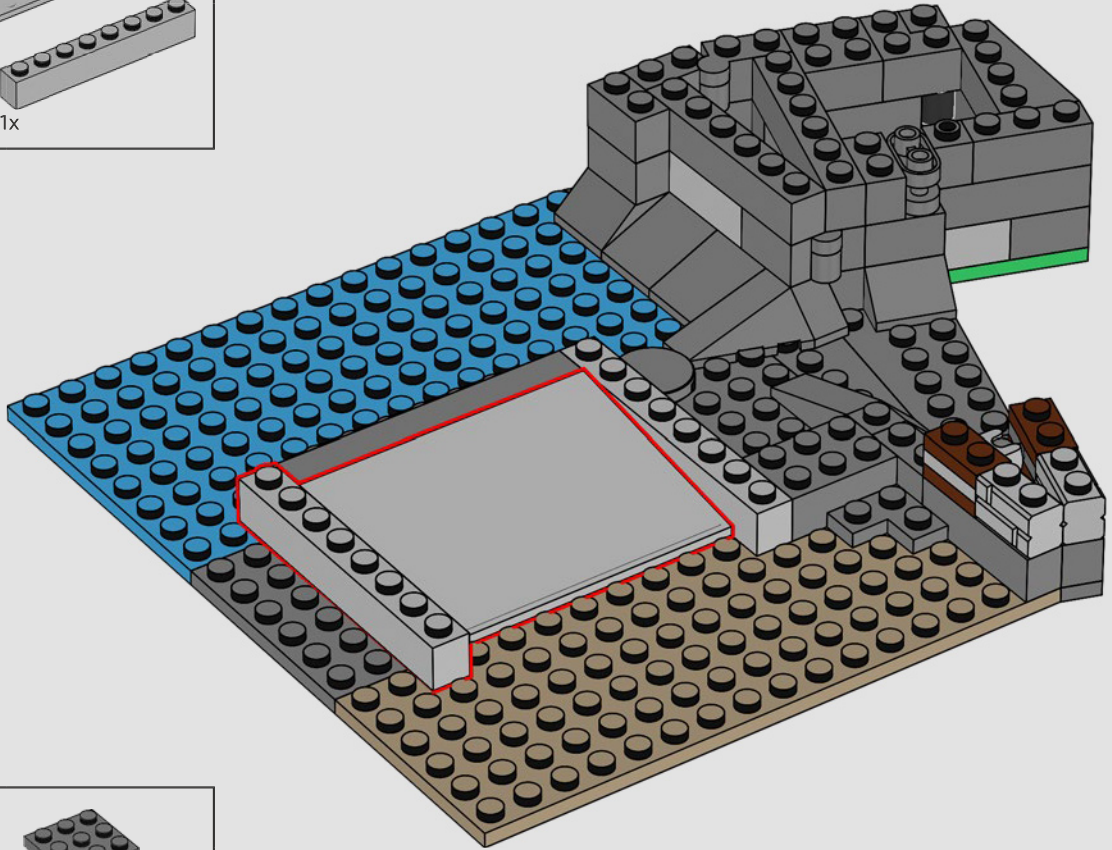

281

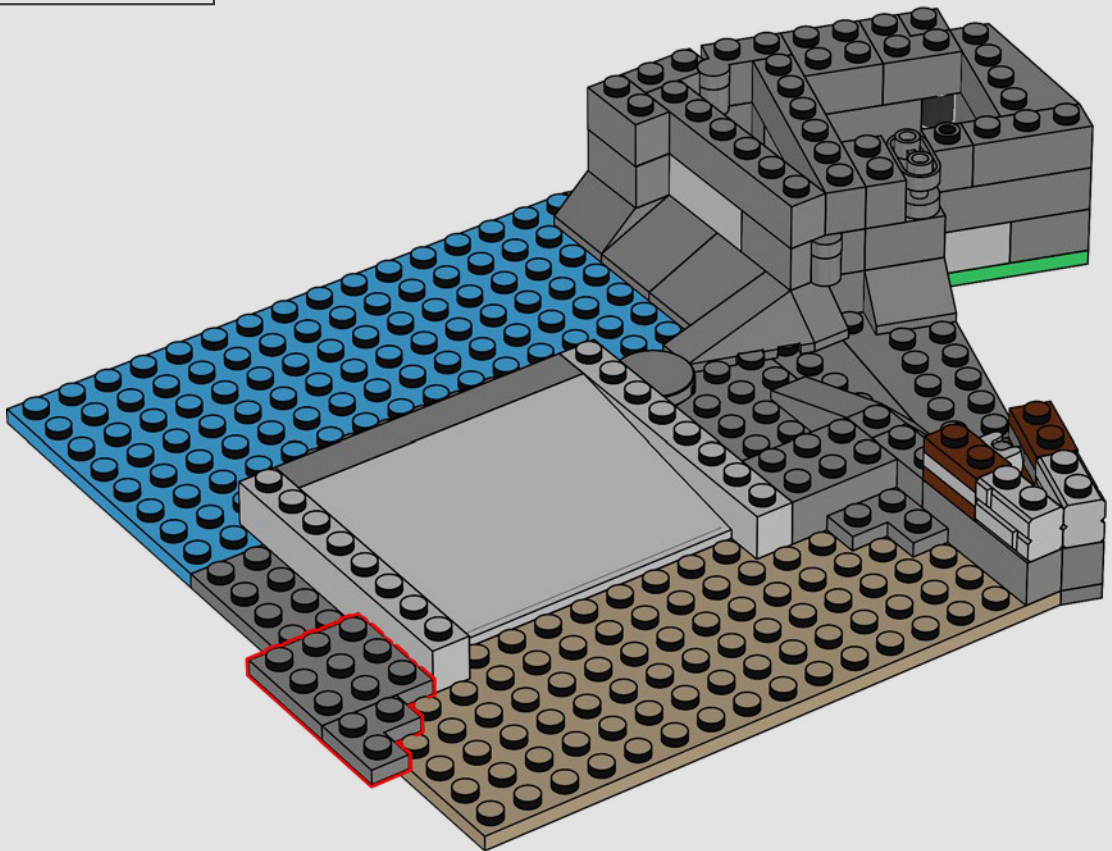

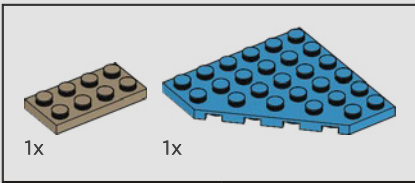

282

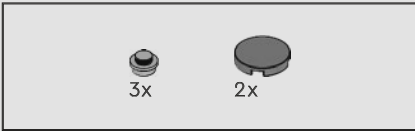
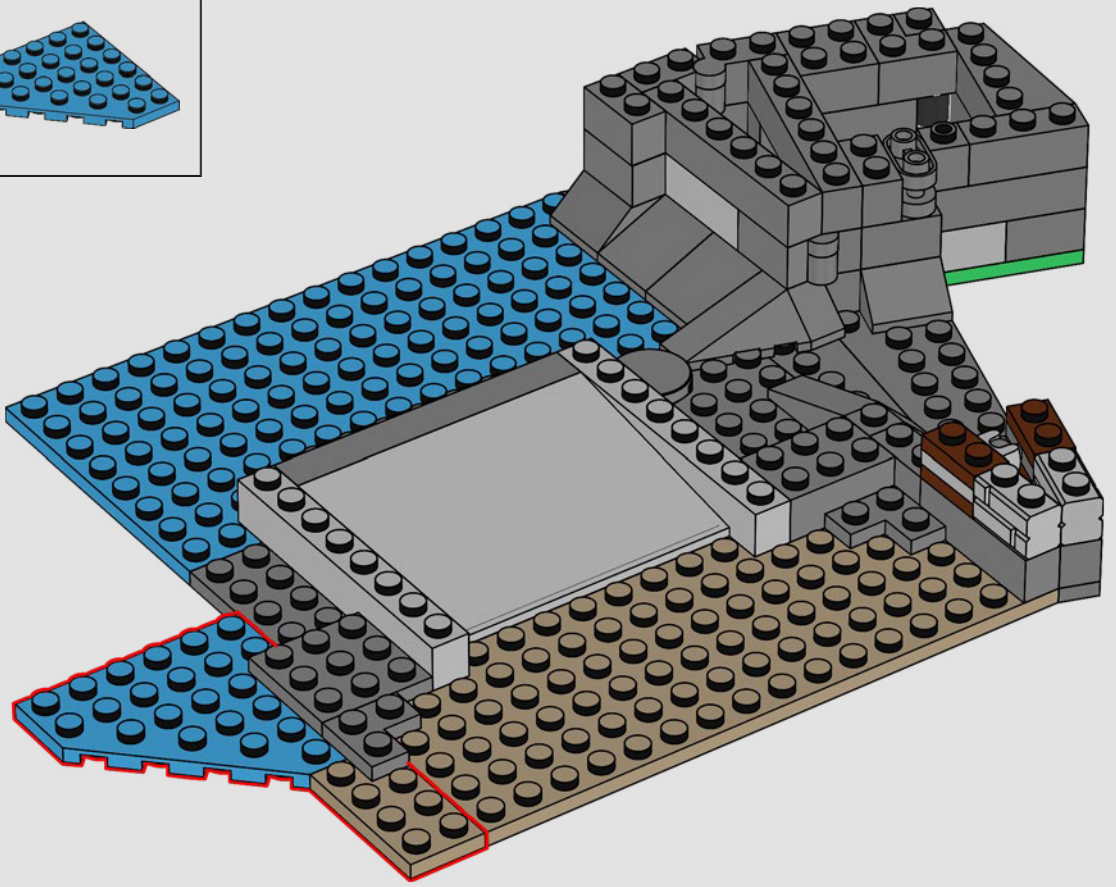

283

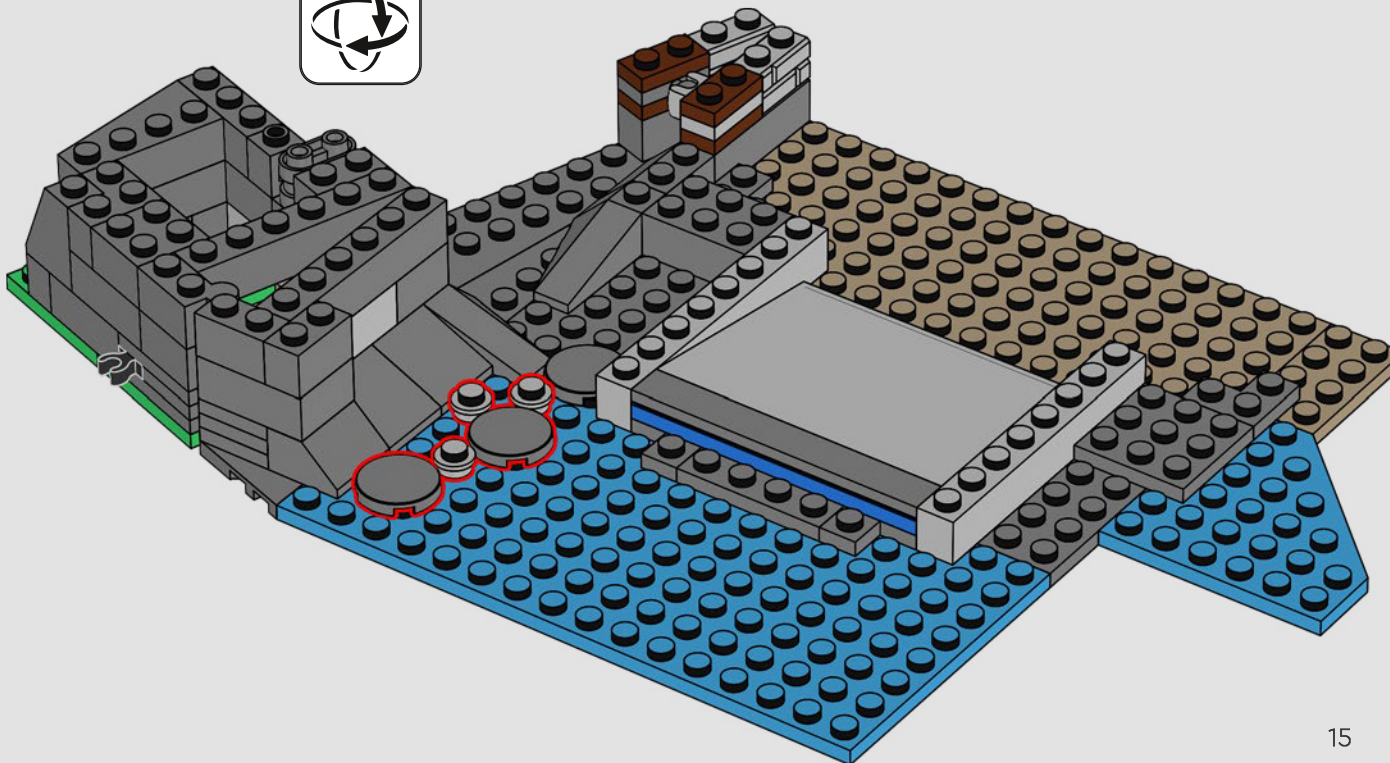

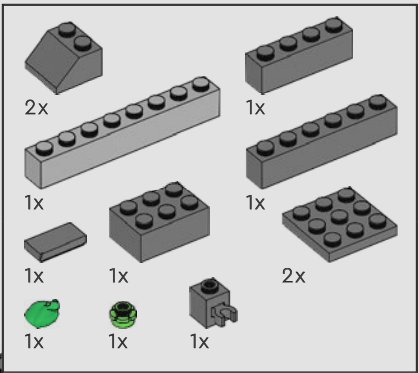

284

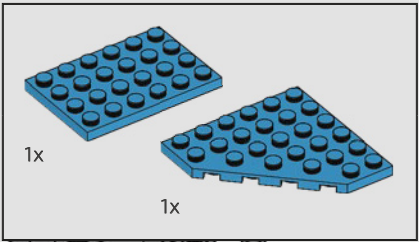
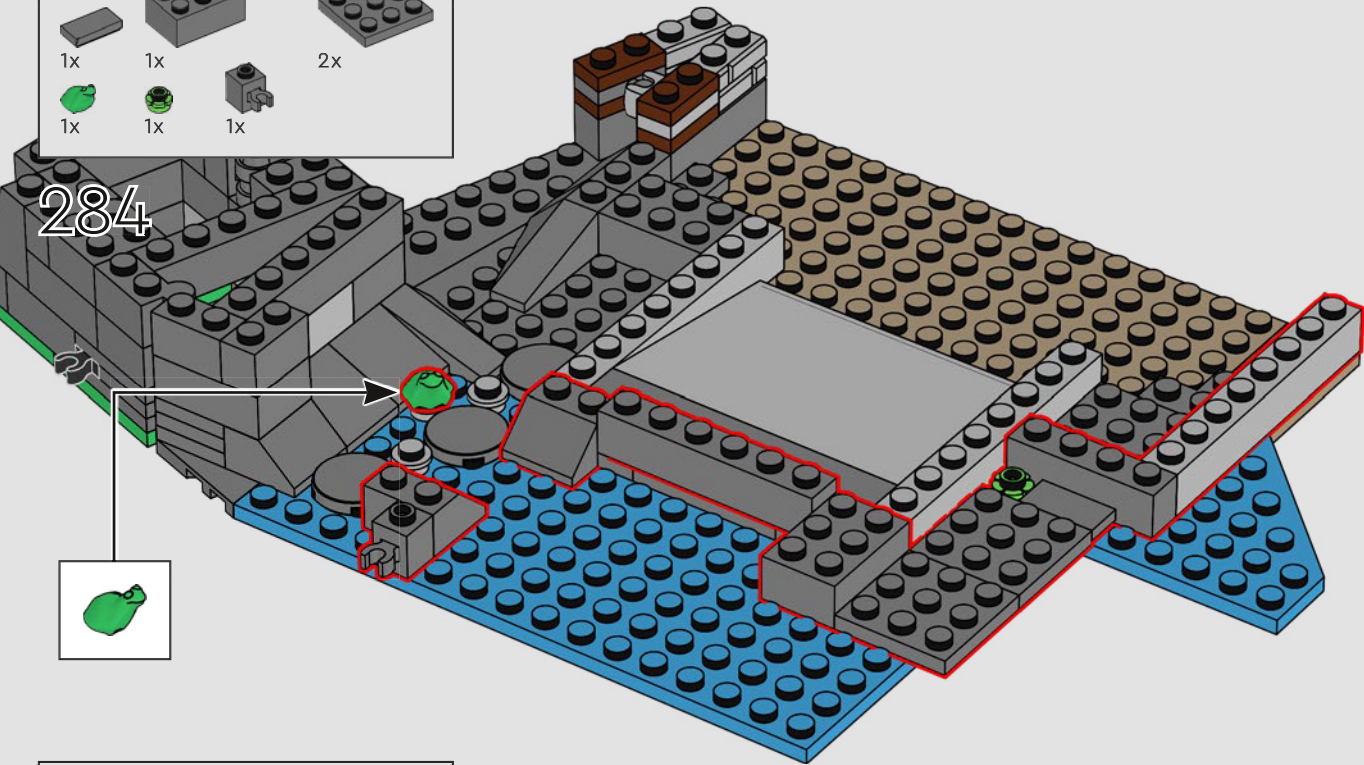

285

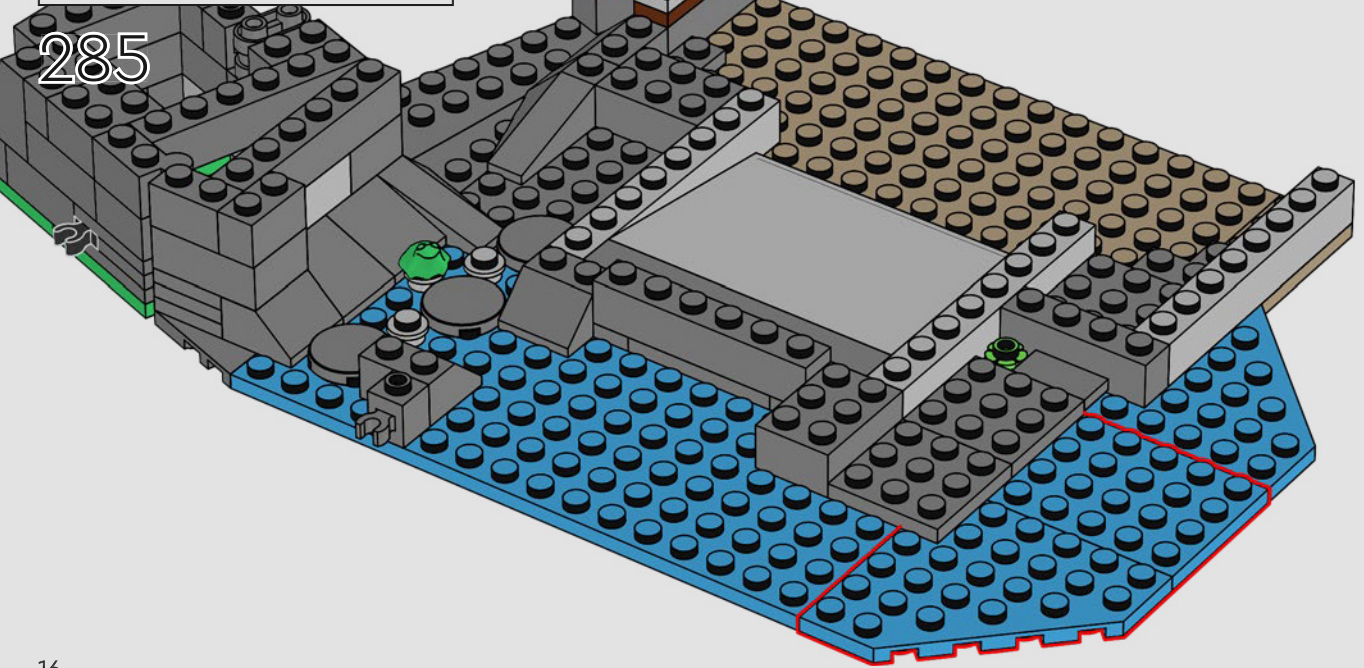

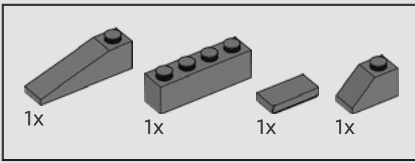

286

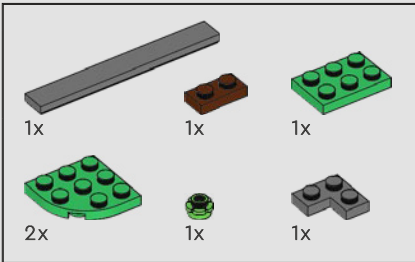
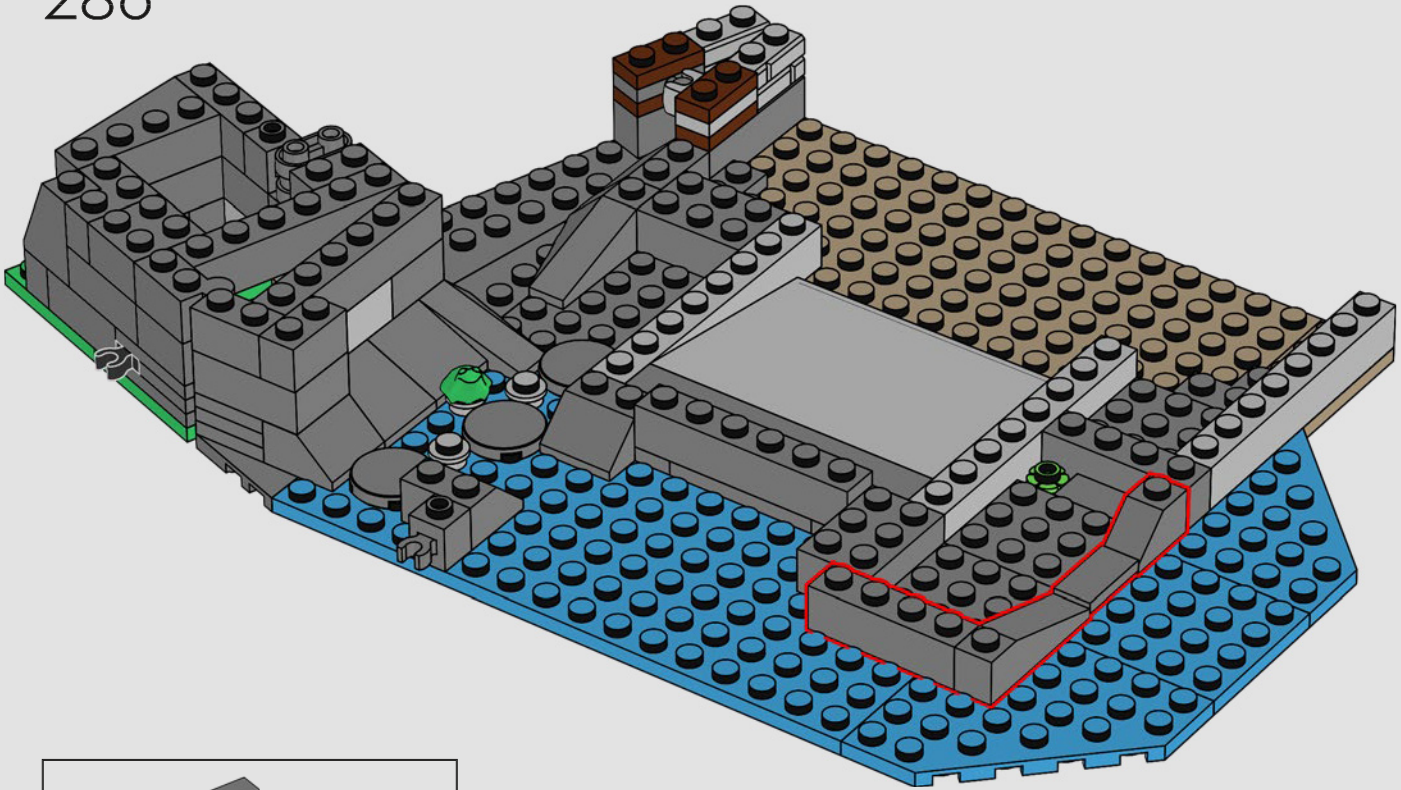

287

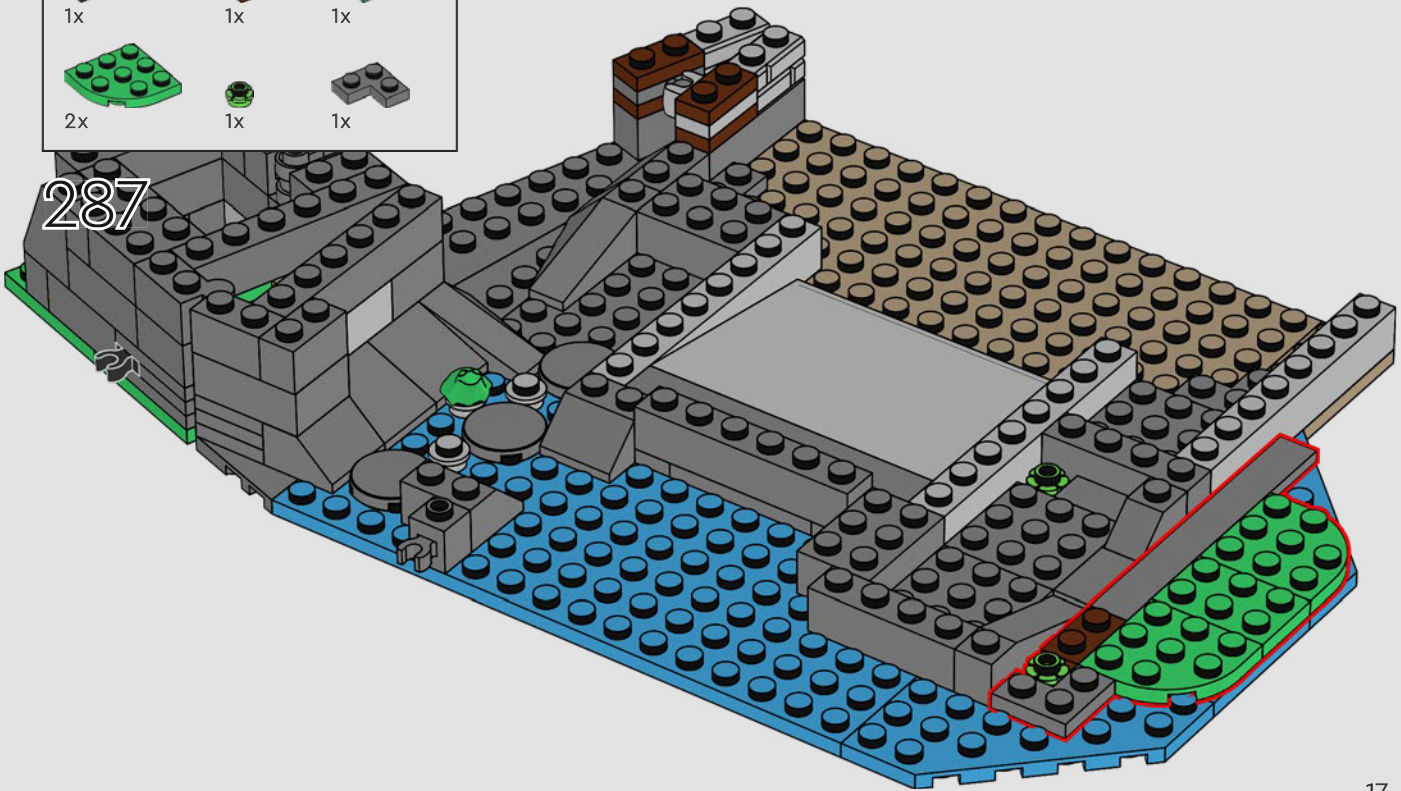

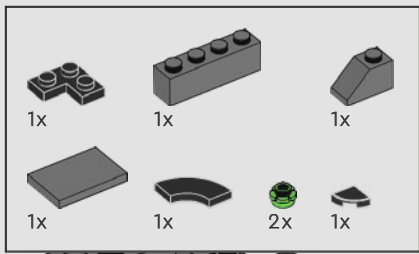

288

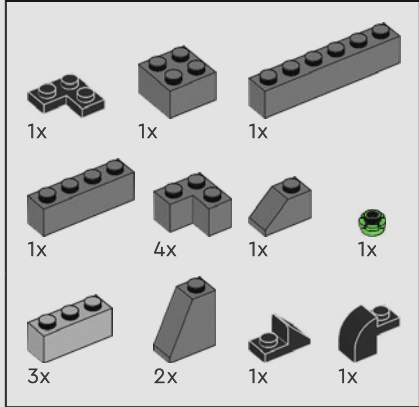
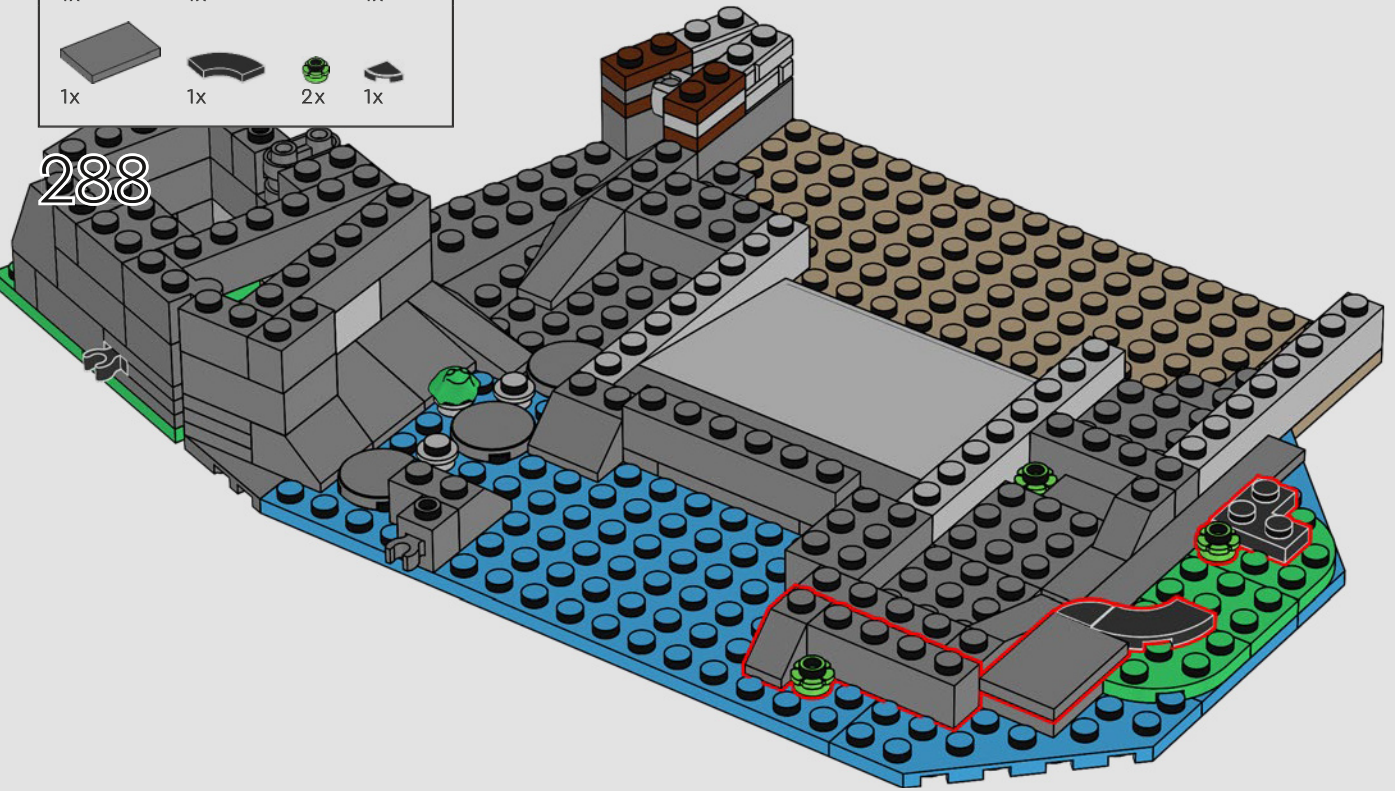

289

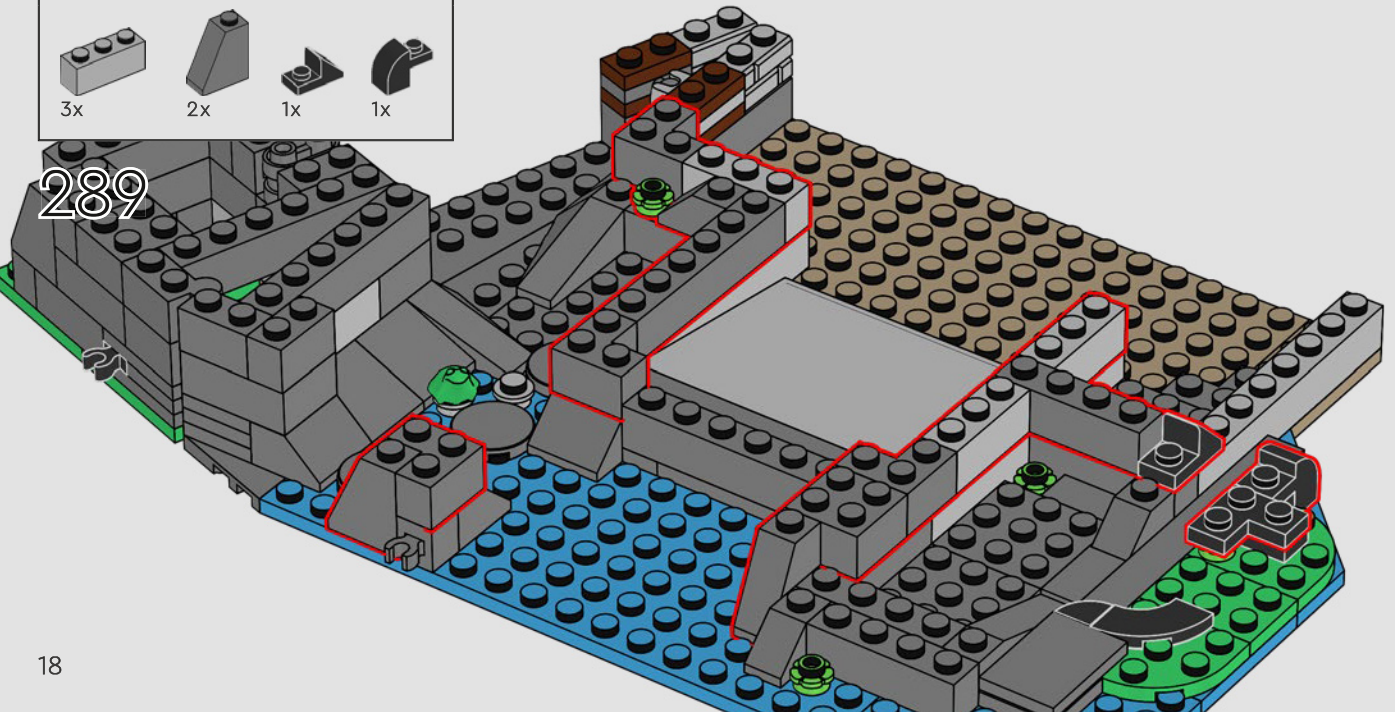

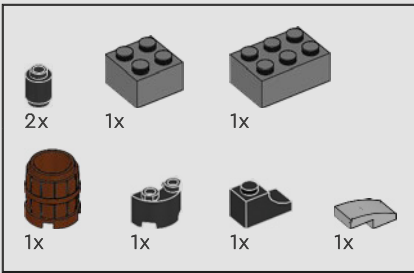

290

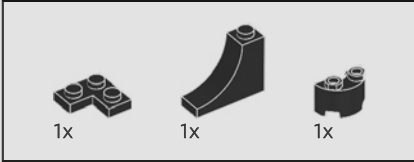
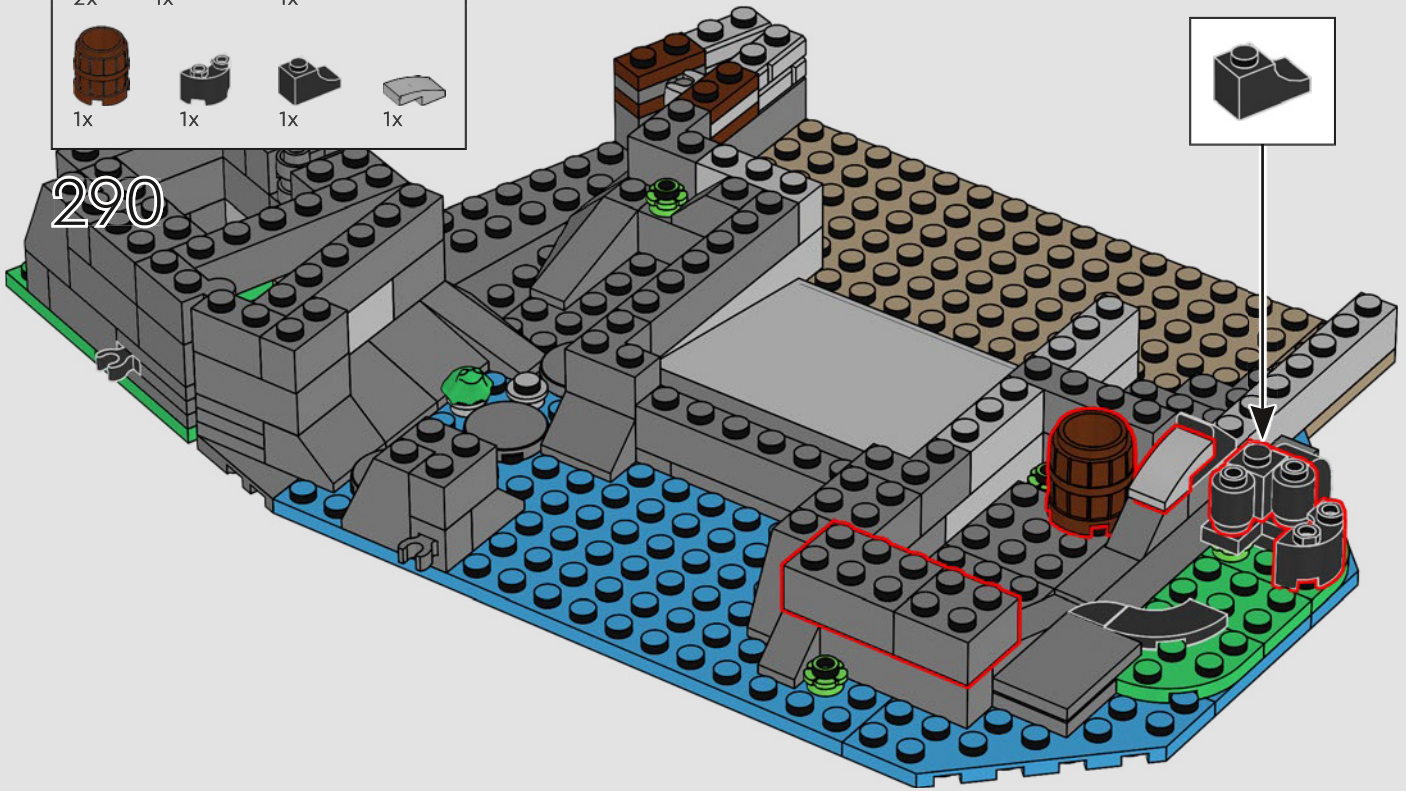

291

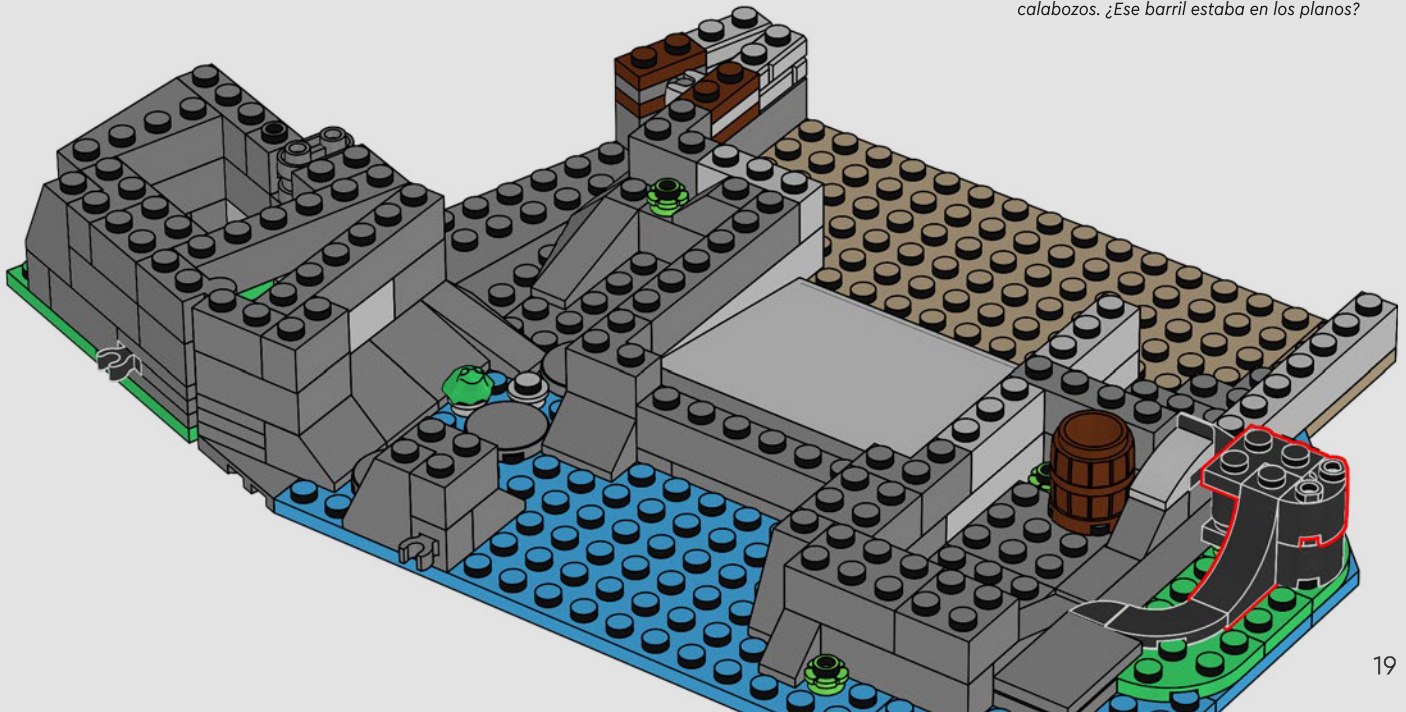

At last, the dungeons, what wonderful cells can be made here! Was that barrel in the original plans?

Finalment, les cachots, qui peuvent accueillir de splendides cellules ! Ce tonneau était-il dans les plans originaux ?

¡Por fin! Aquí podrán hacerse unos maravillosos calabozos. ¿Ese barril estaba en los planos?

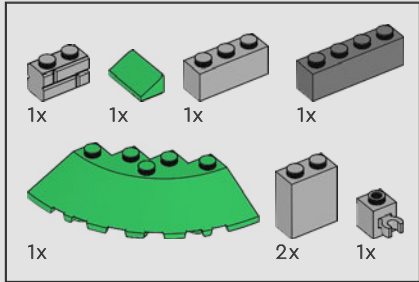

292

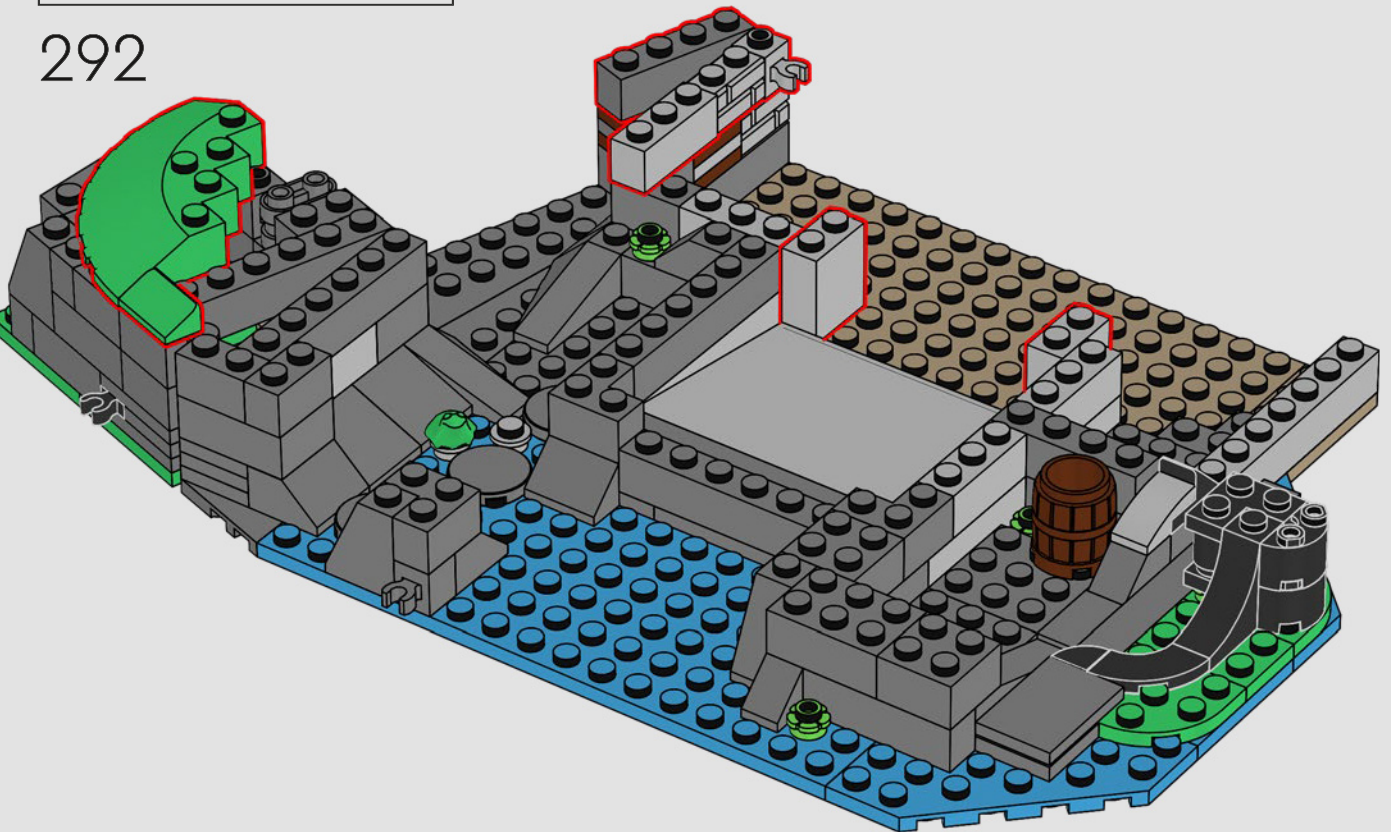

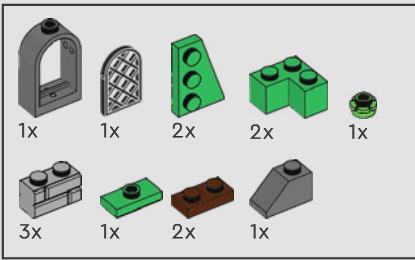

293

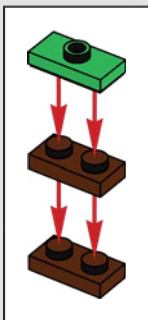
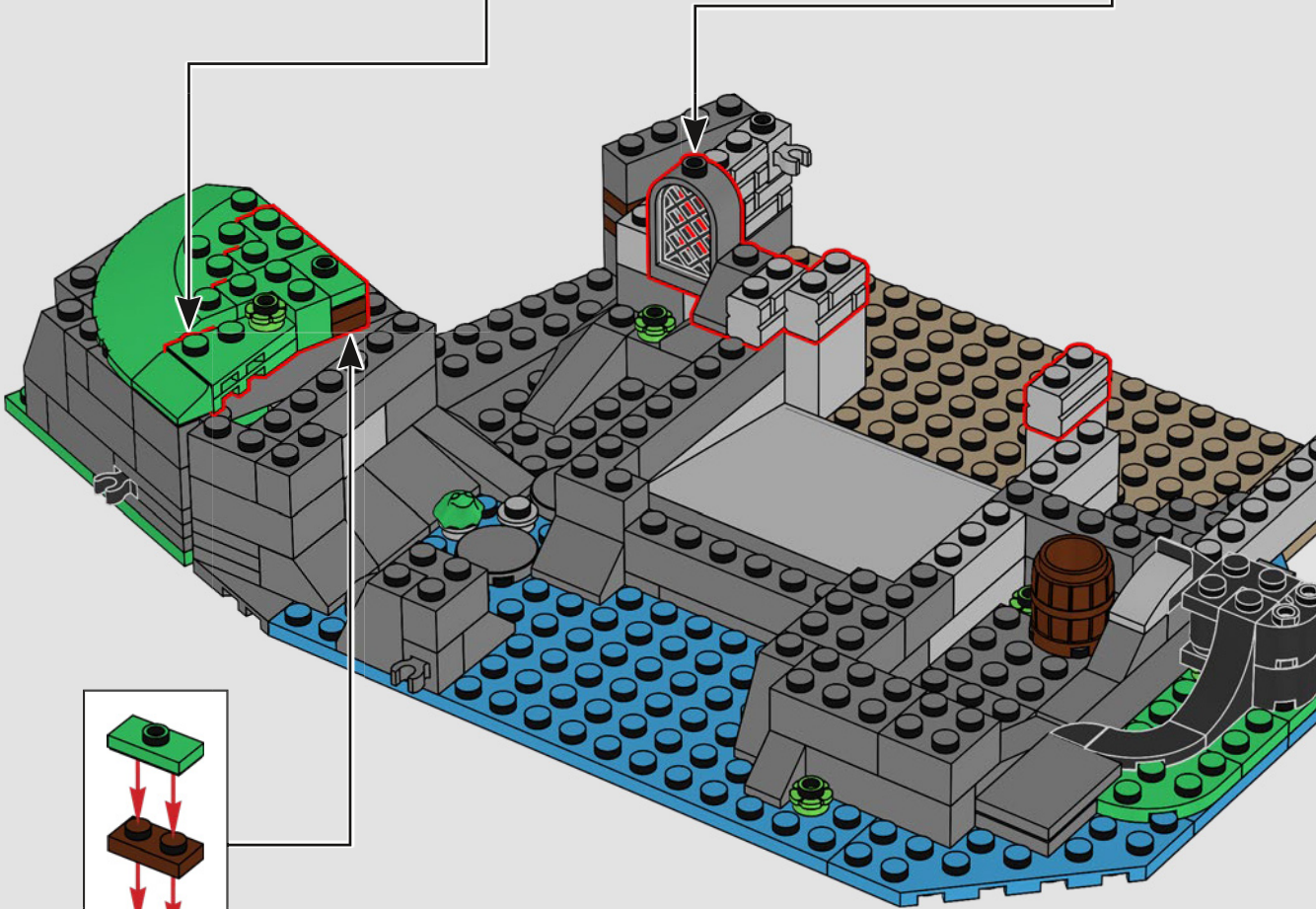
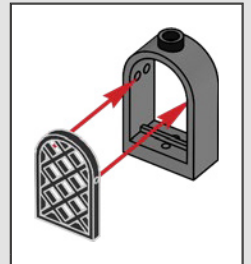
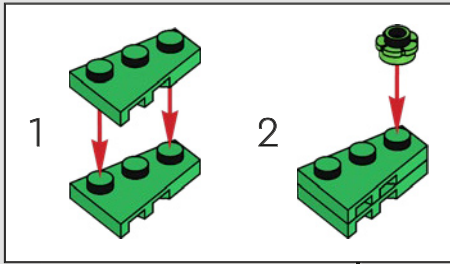

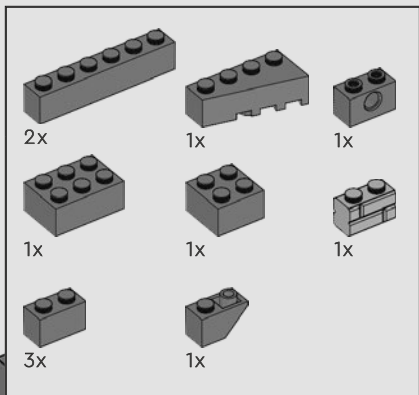

294

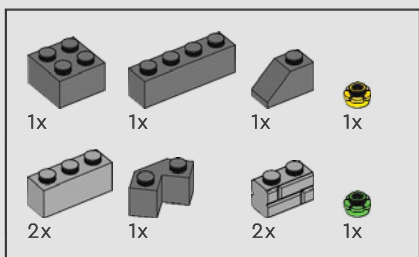
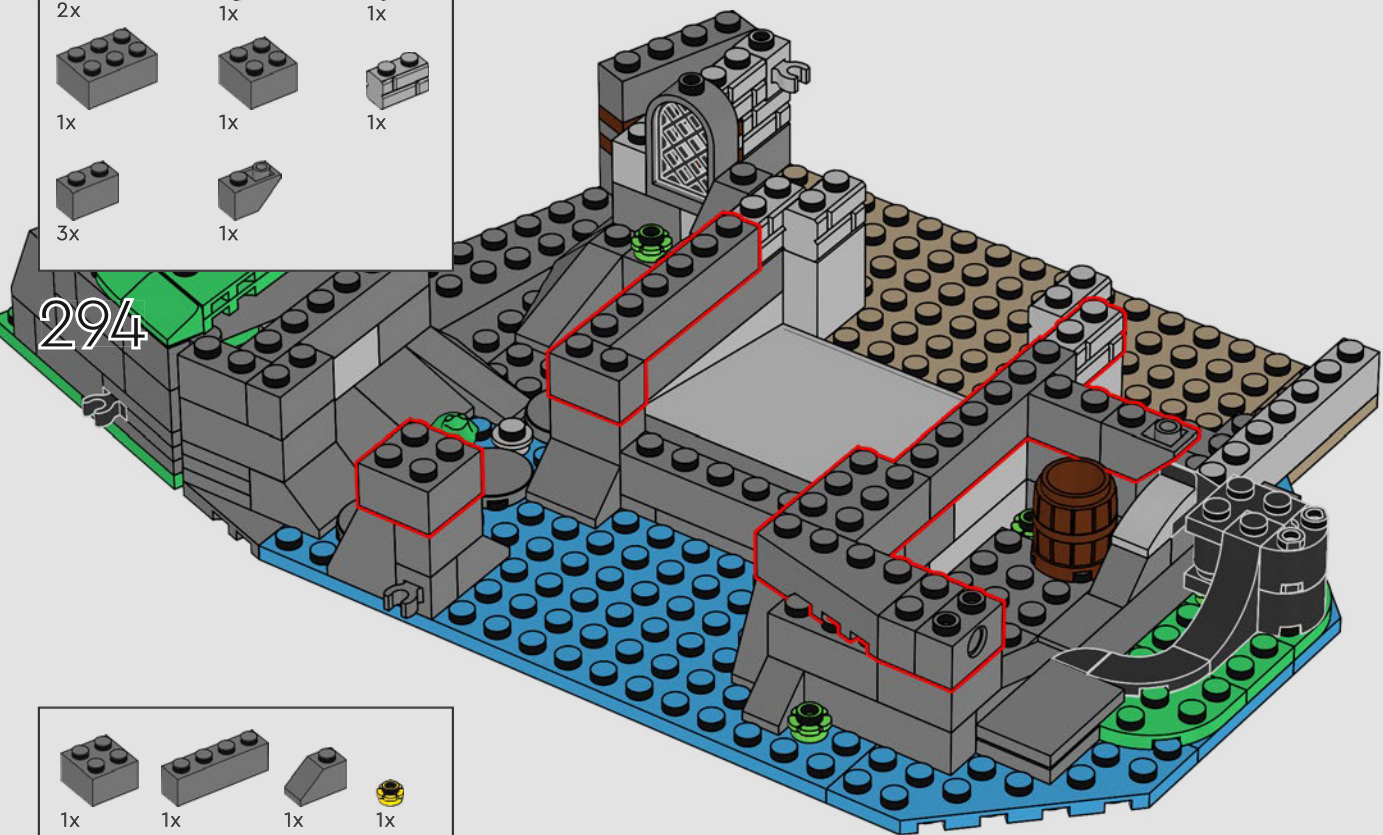

295

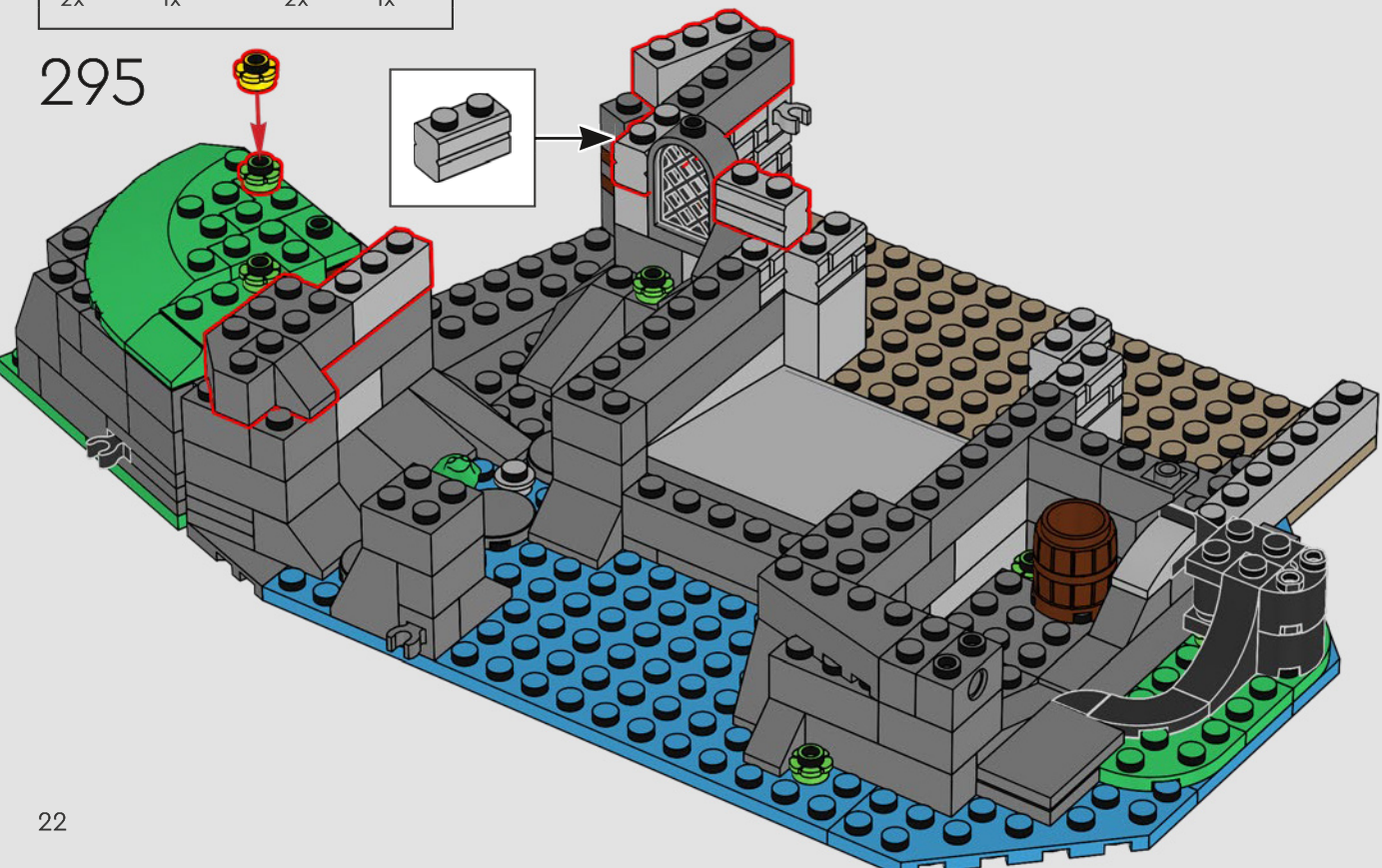

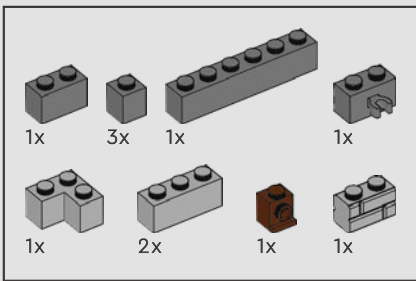

296

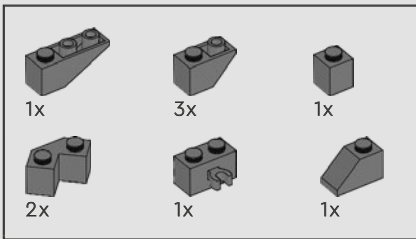
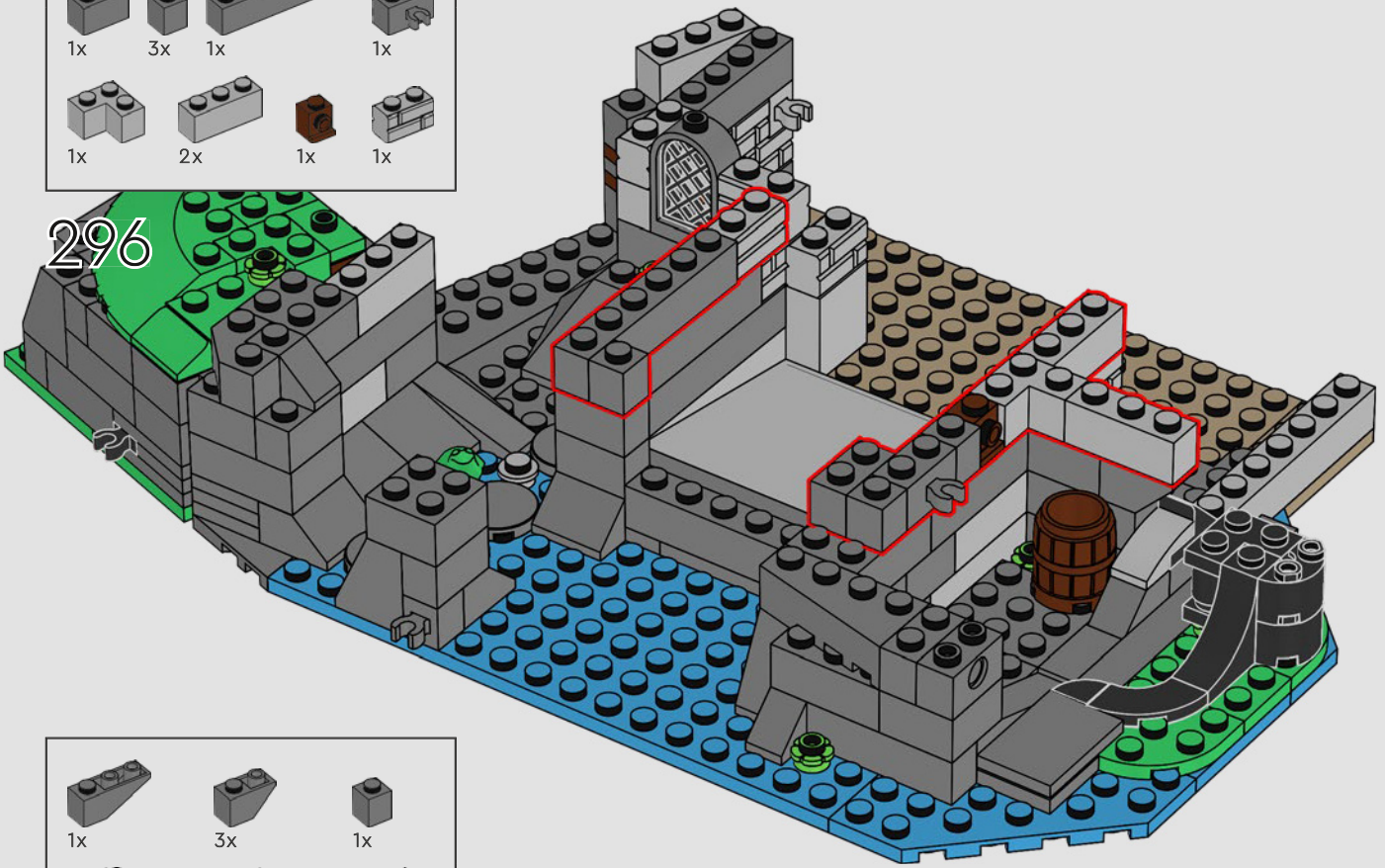

297

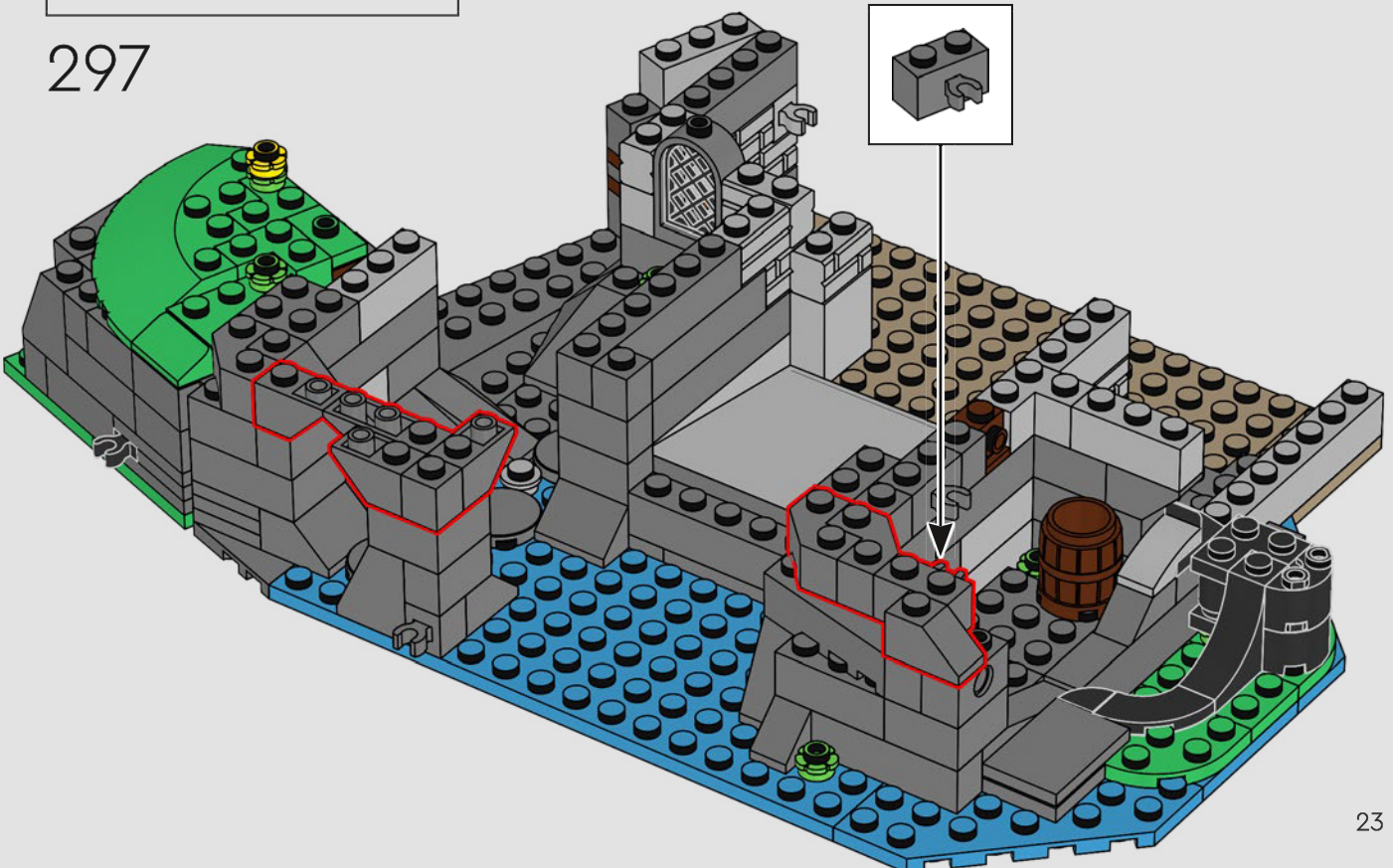

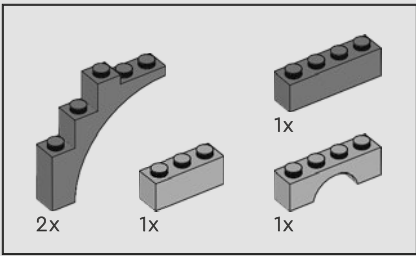

298

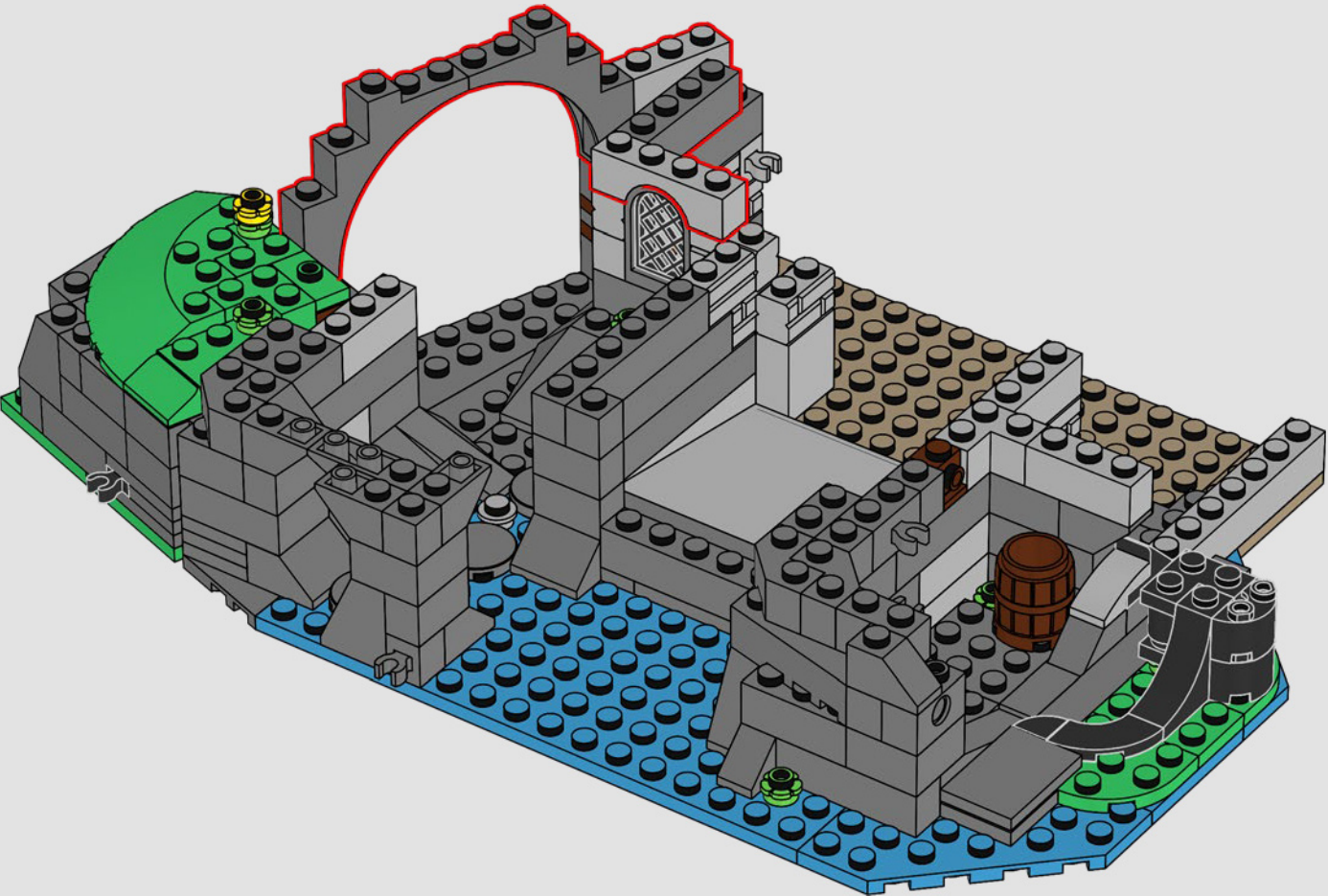

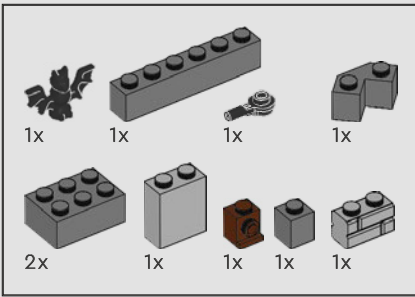

299

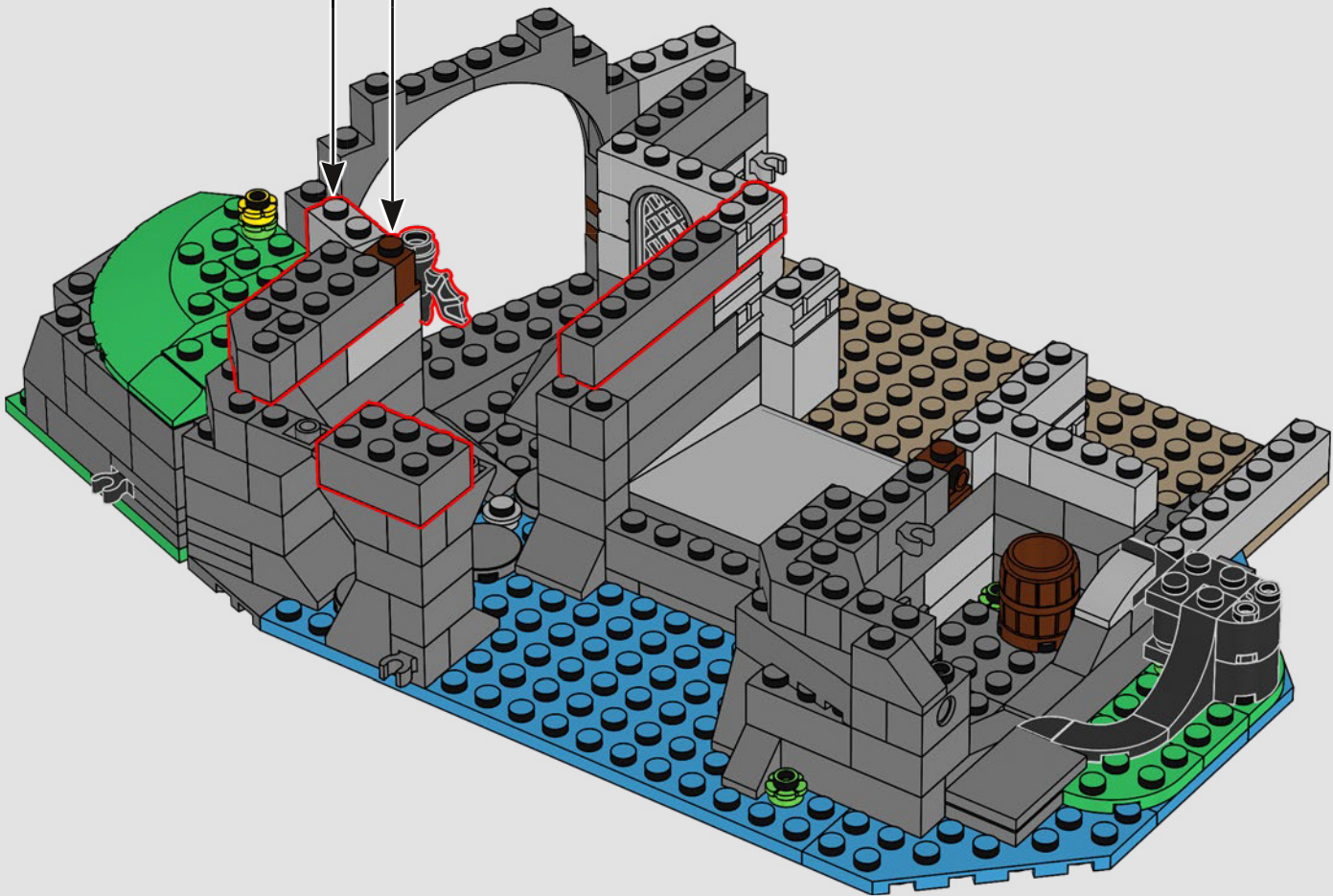
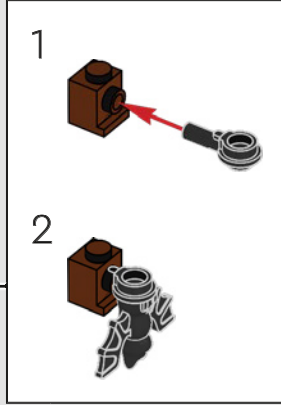
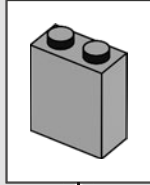

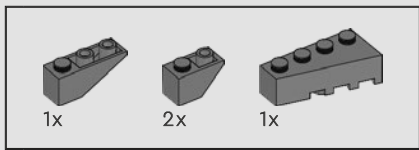

300

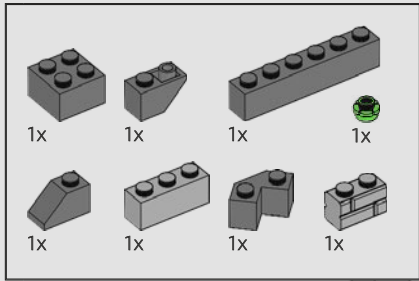
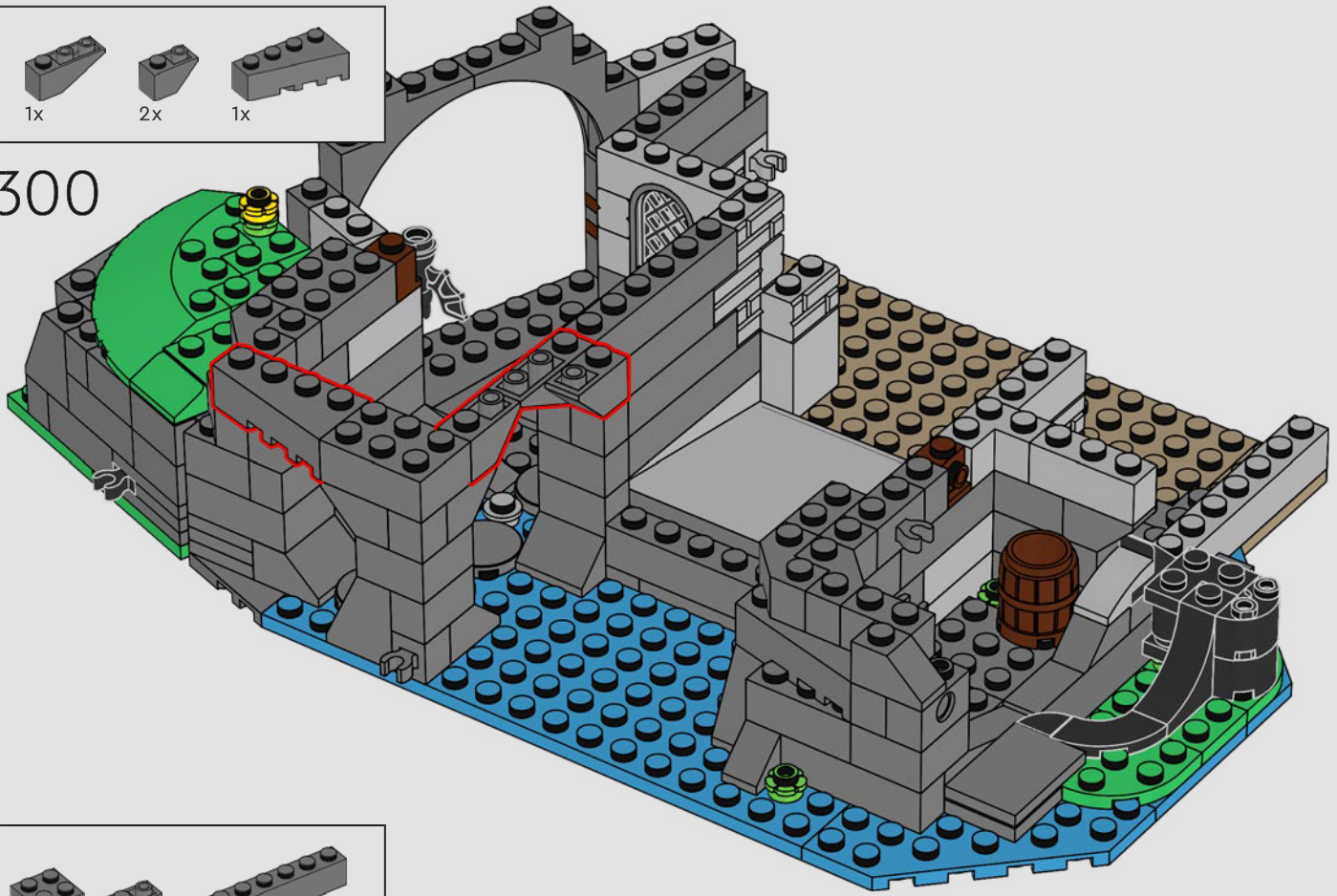

301

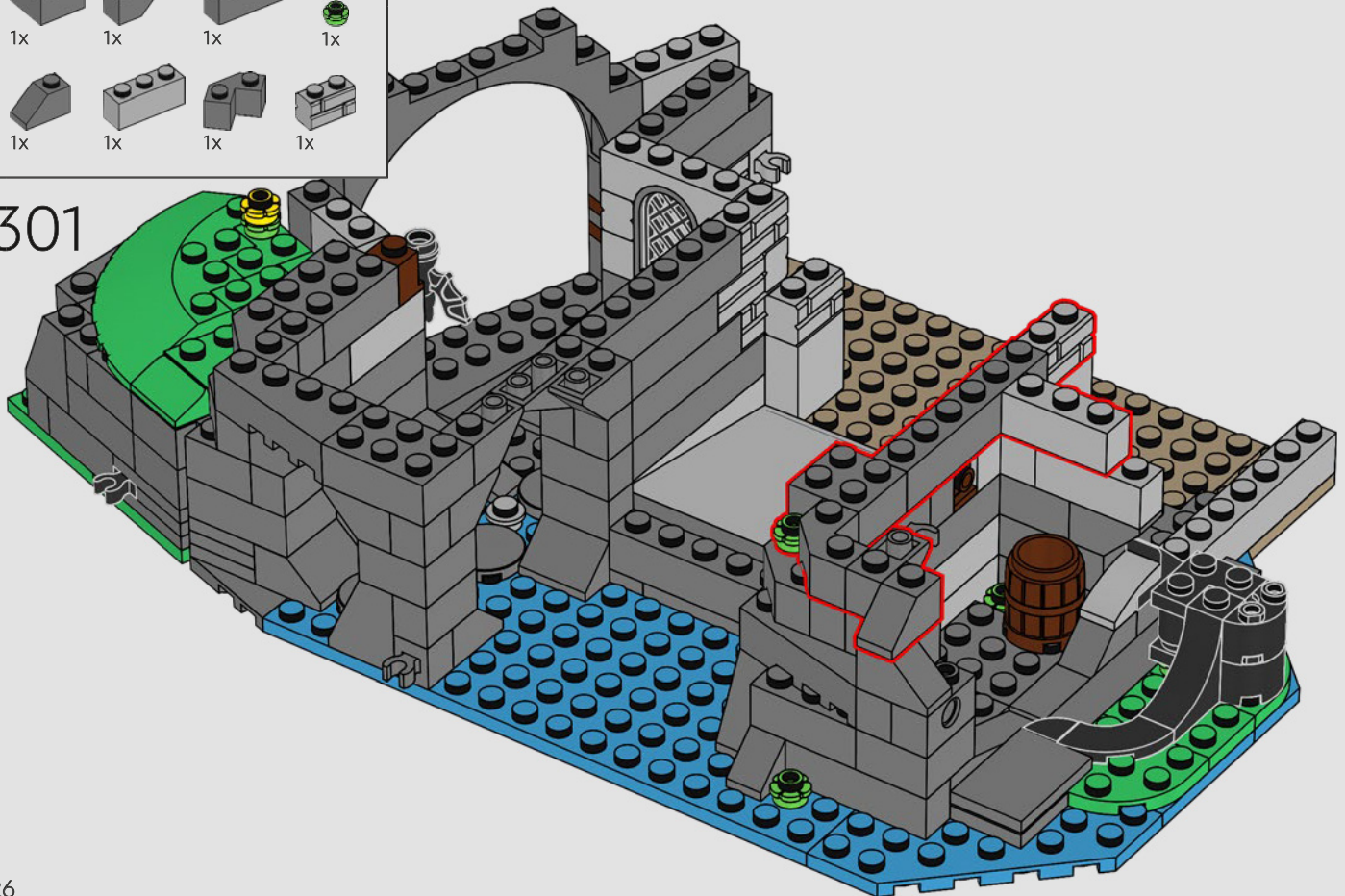

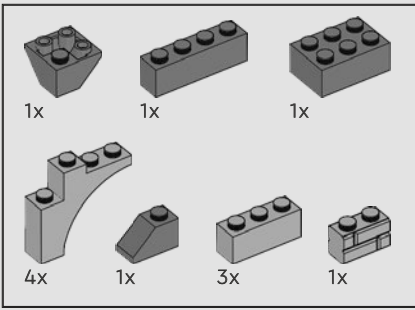

302

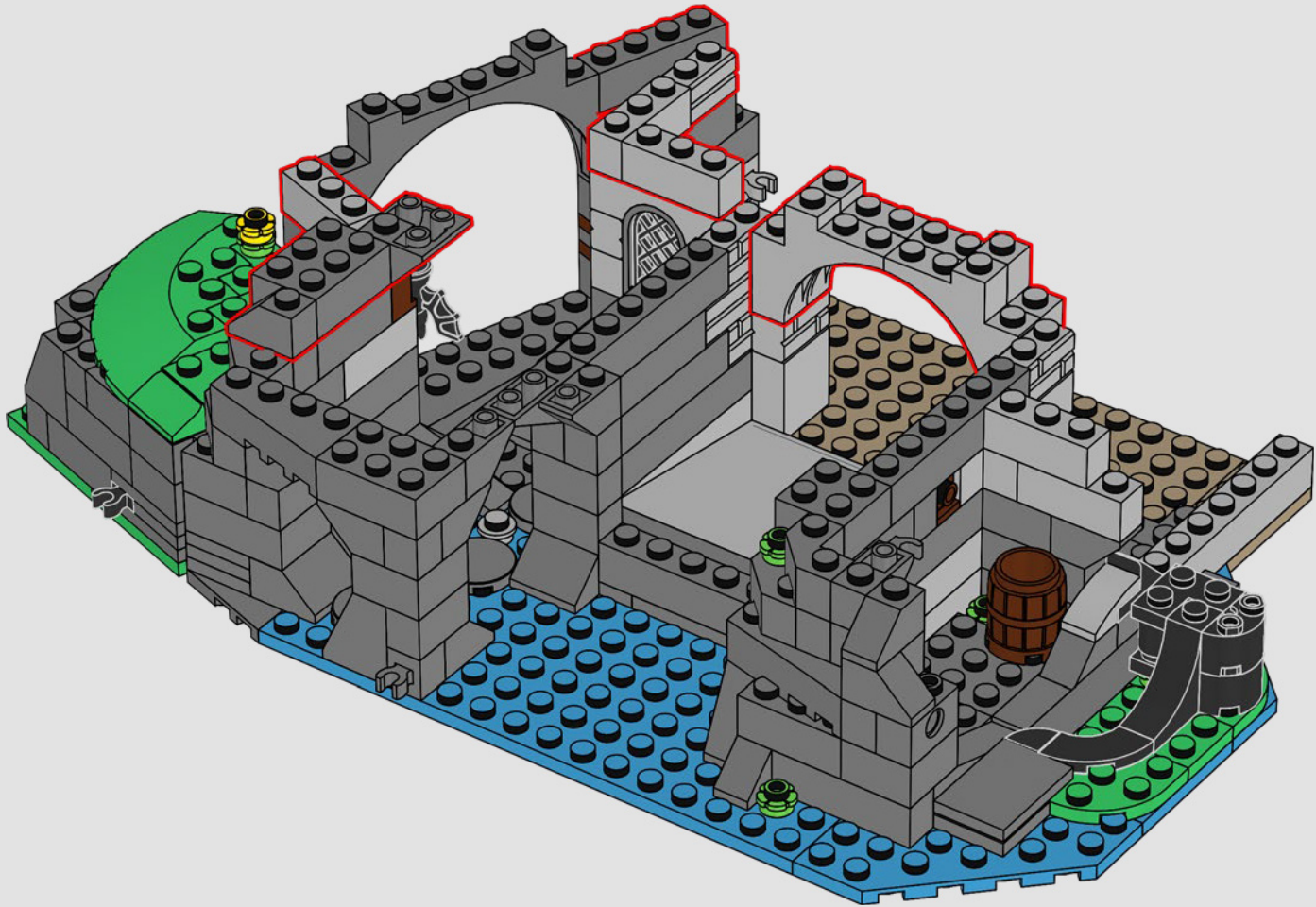

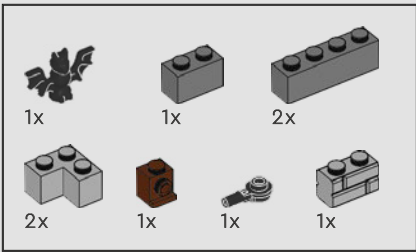

303

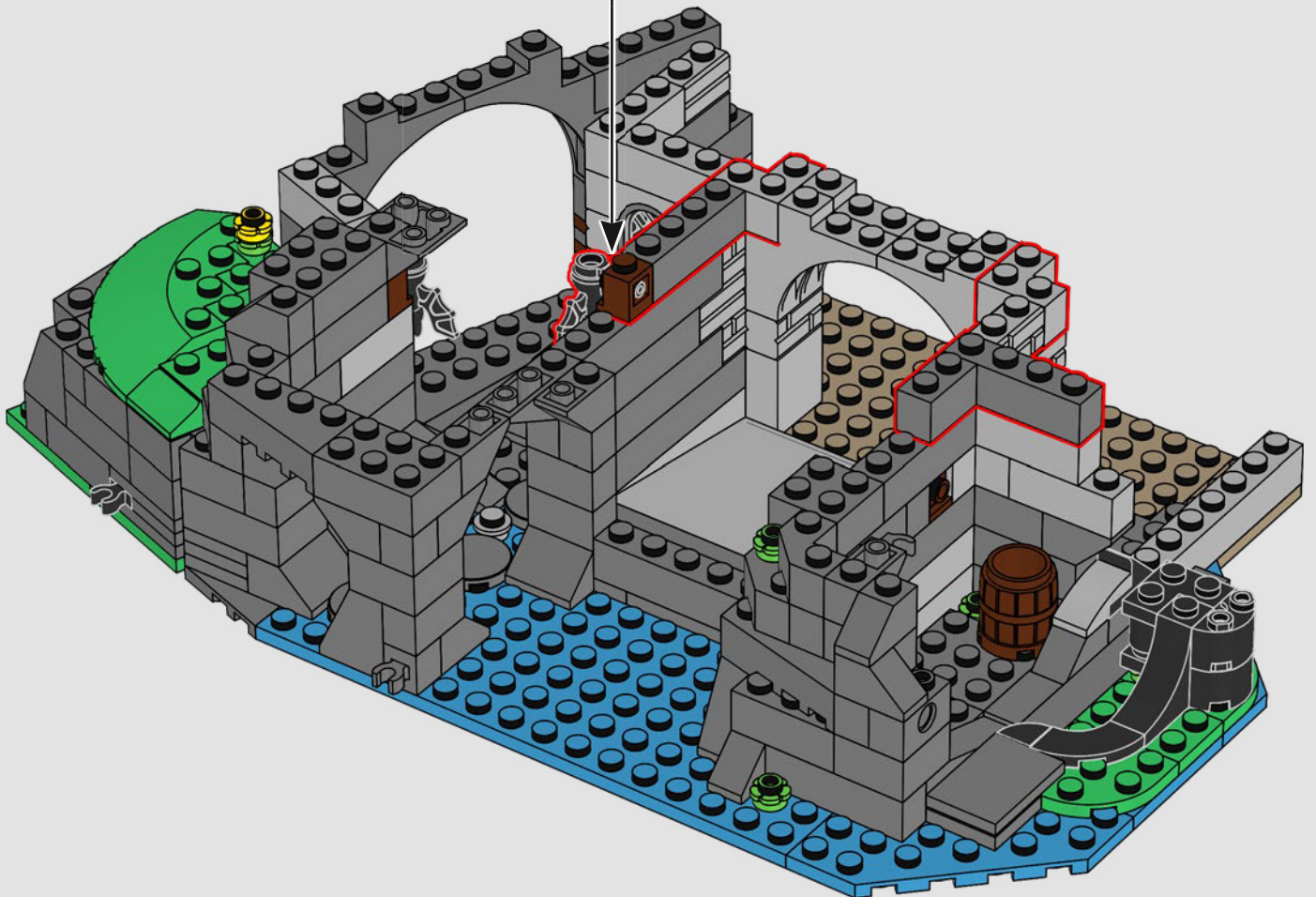
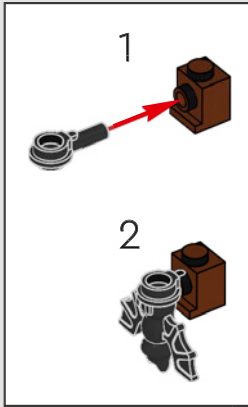

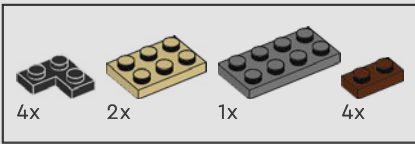

304

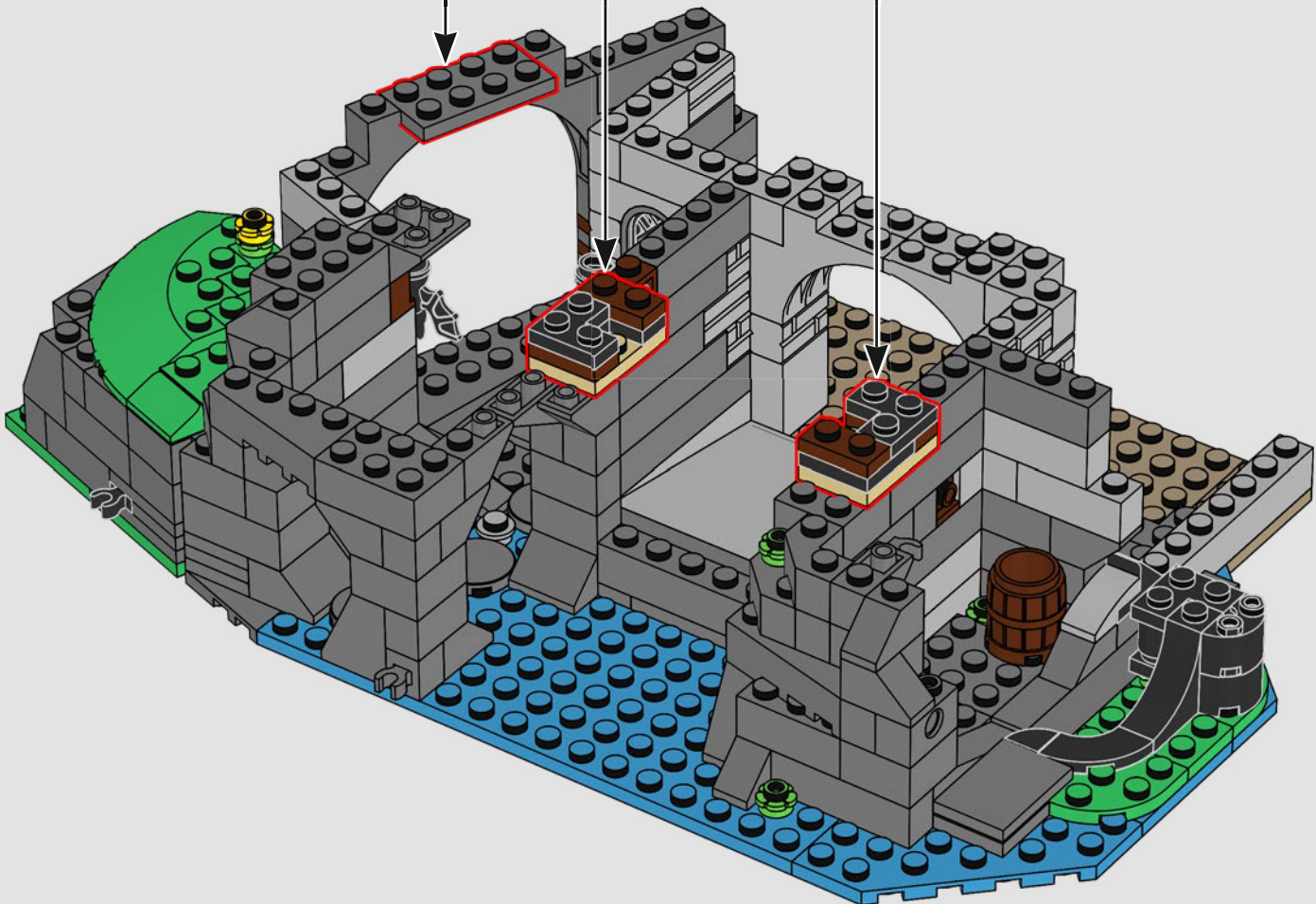
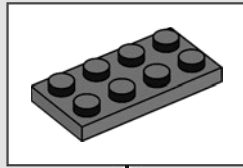
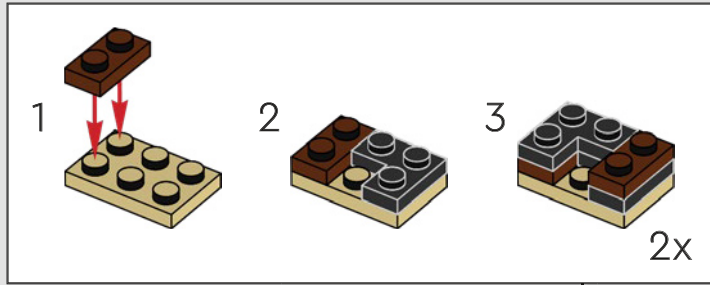

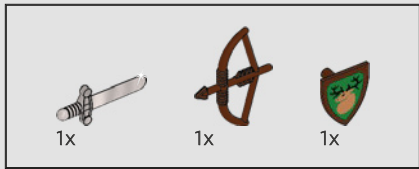

The mighty Elk shield. There be forest folk nearby.

Le puissant bouclier de wapiti. Les gens de la forêt ne doivent pas être loin.

El poderoso Escudo del Ciervo. Debe haber pobladores del bosque cerca.

305

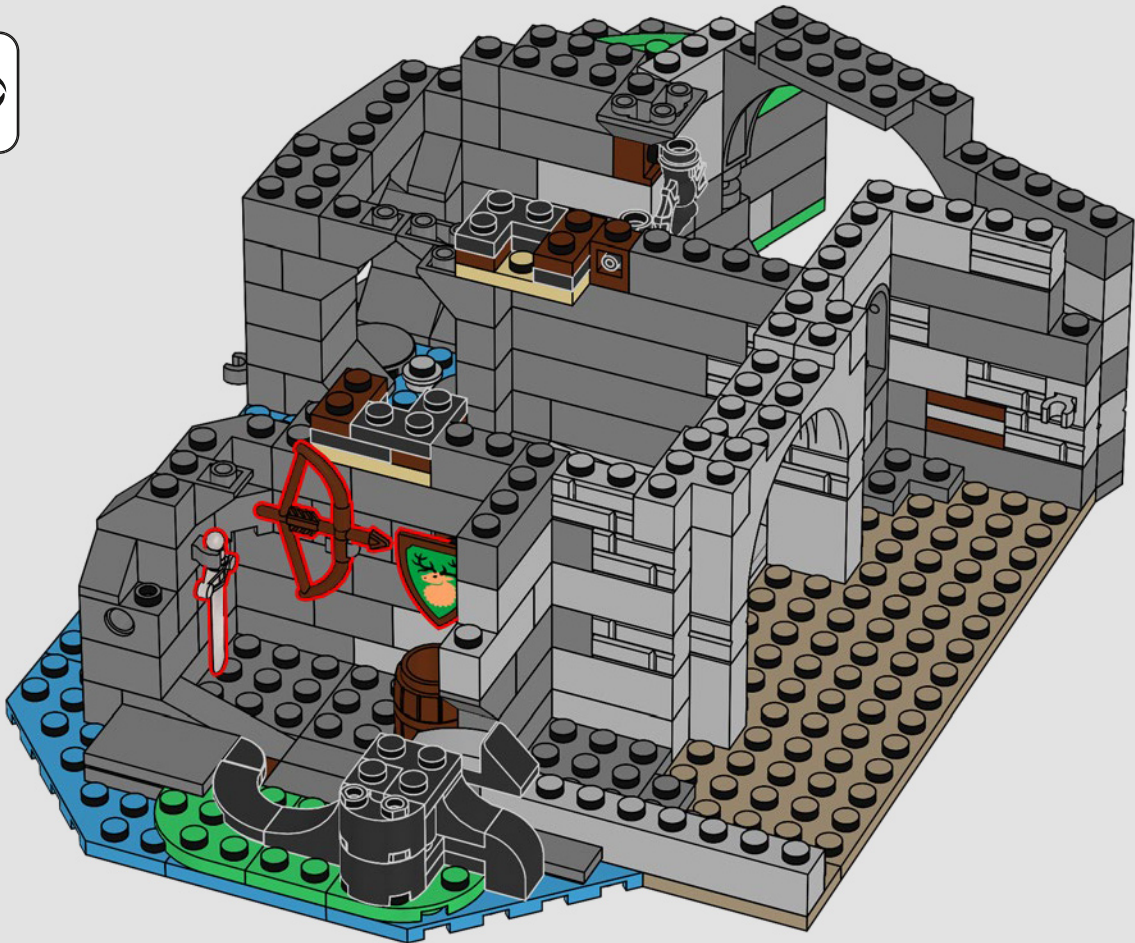

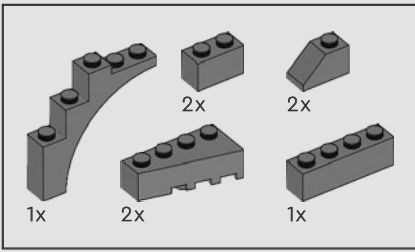

306

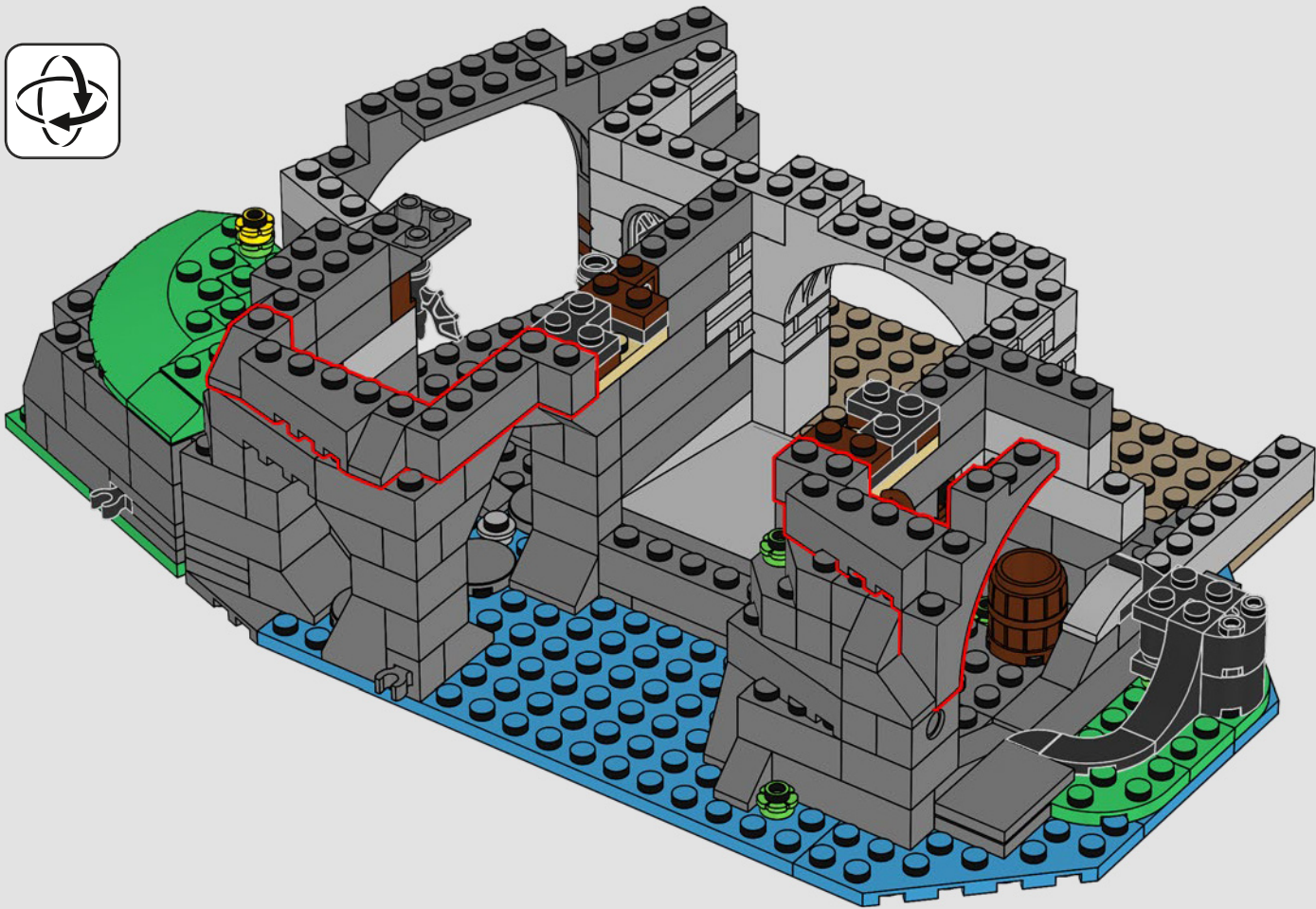



307

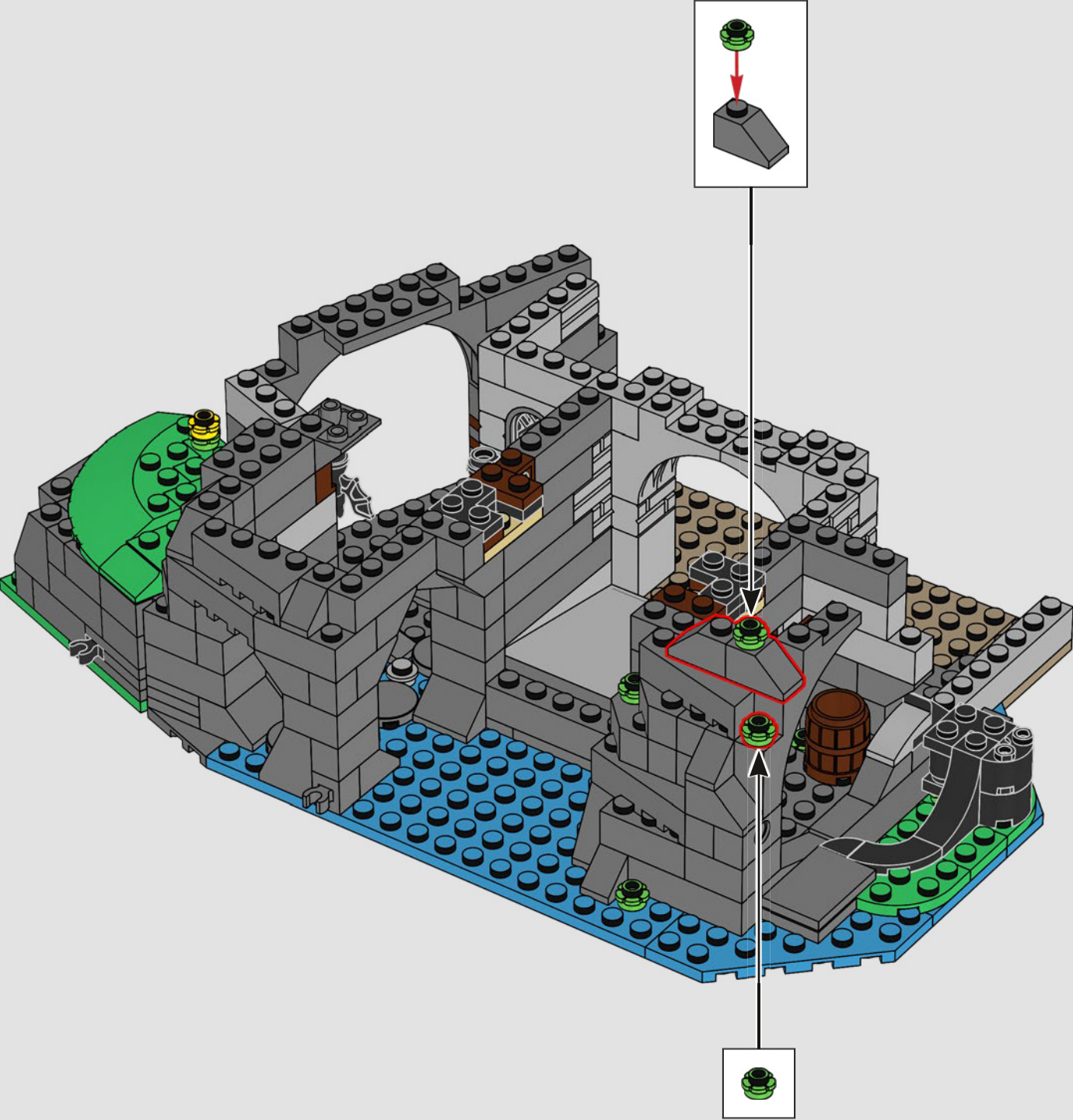



Back in a body! That's better, though it's not quite as I remember it. 28 years is far too long to be without it!

De nouveau en chair et en os ! C'est mieux, même si ce n'est pas tout à fait comme dans mes souvenirs. 28 ans sans corps, c'est beaucoup trop long !

¡De regreso en un cuerpo! Es mejor, aunque no tan parecido a como lo recuerdo. ¡28 años es mucho tiempo para estar sin uno!

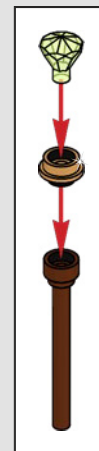
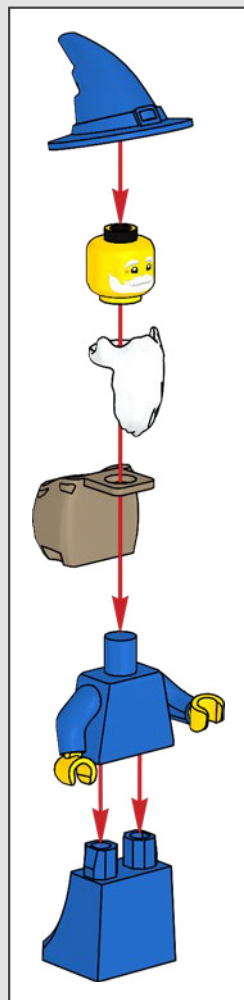

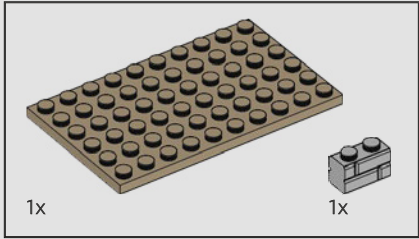
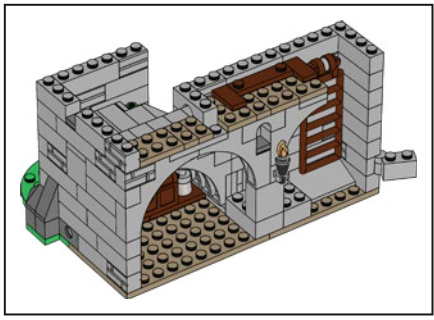

308

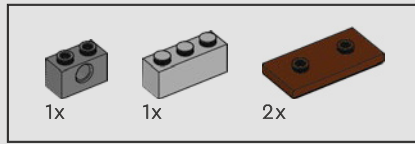
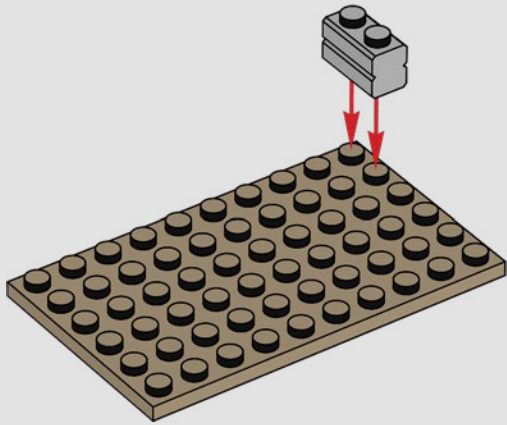

309

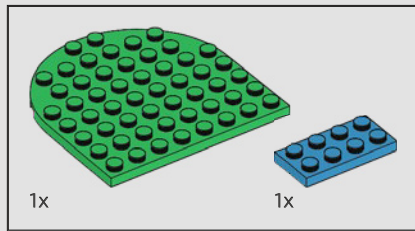
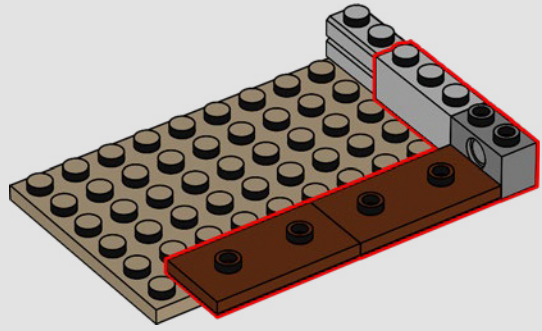

310

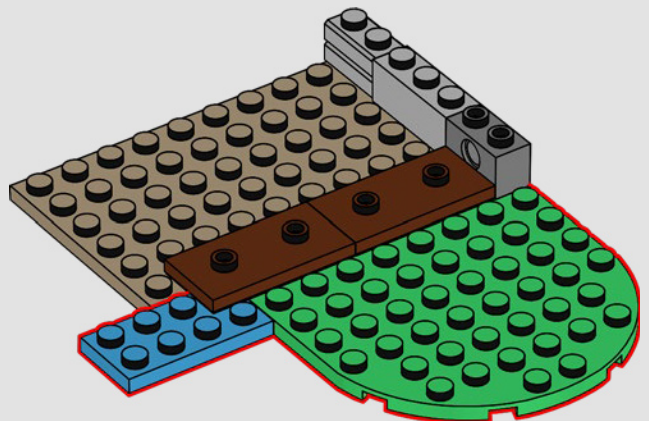

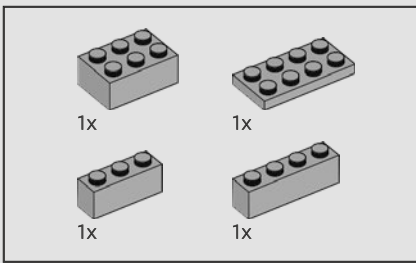

311

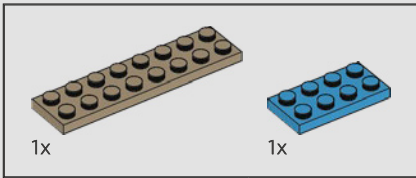
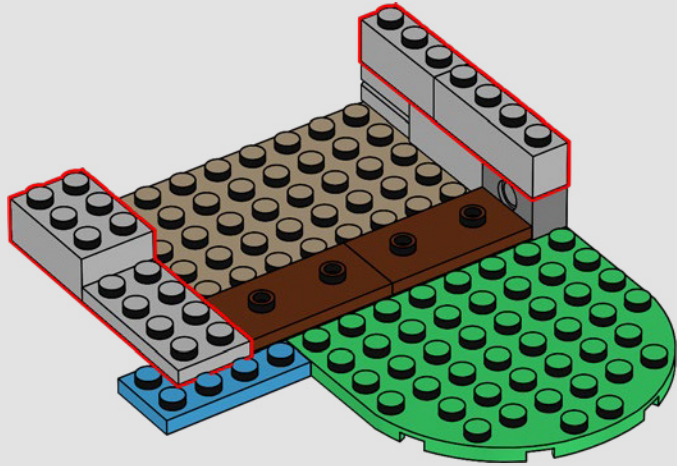

312

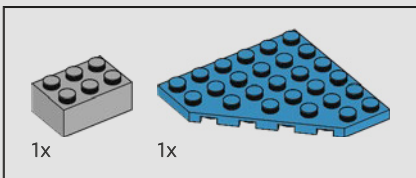
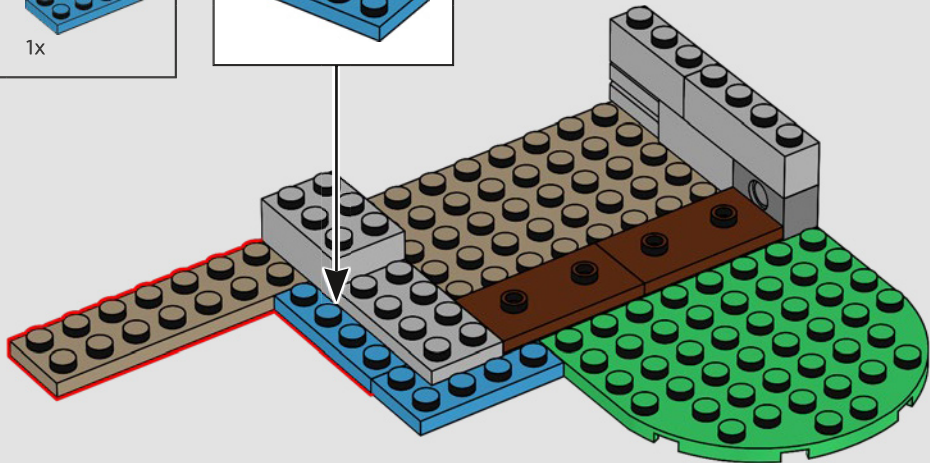
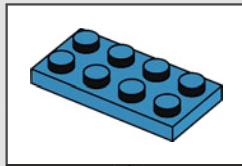

313

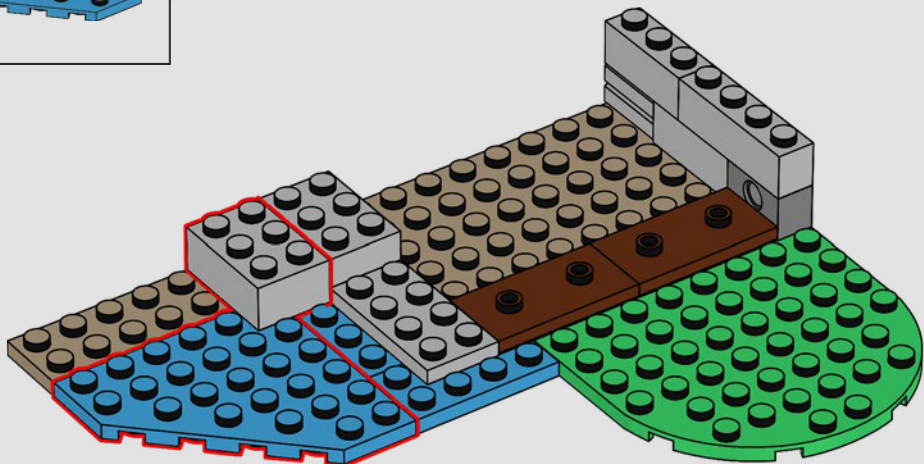

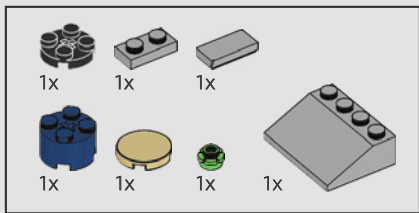

314

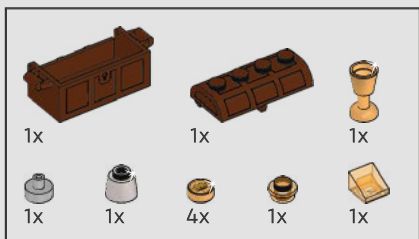
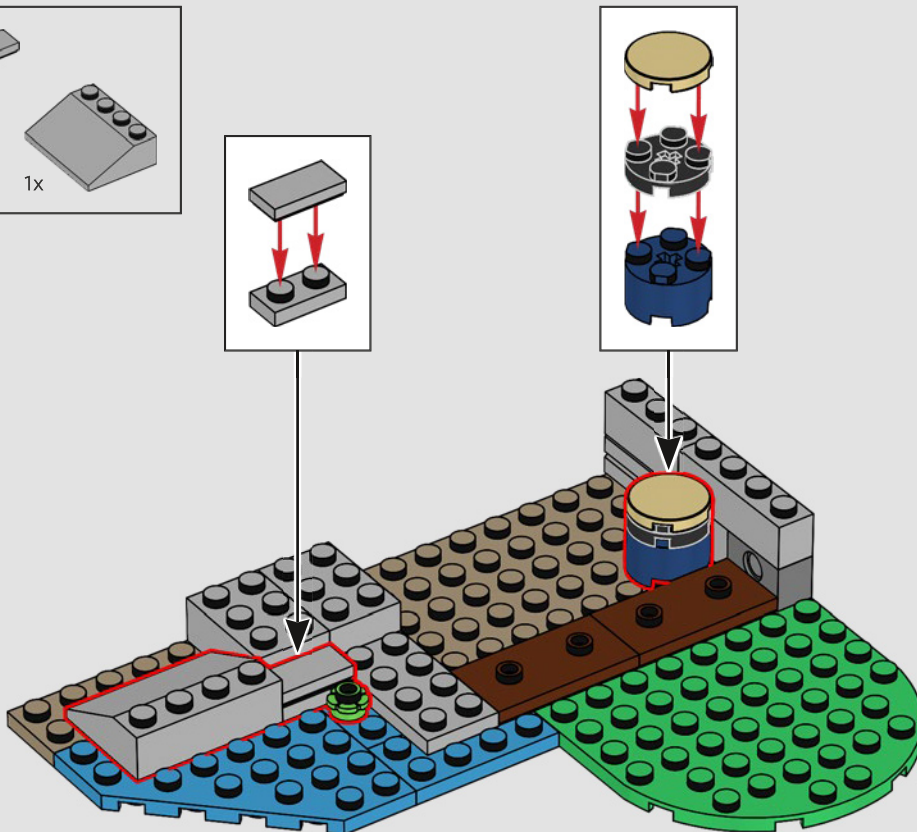

315

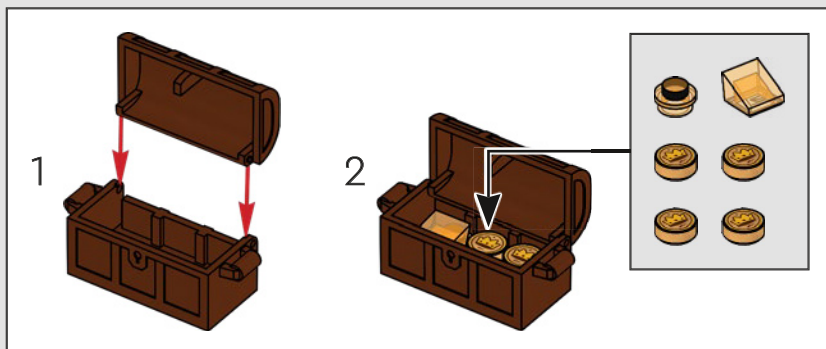

Ahhh yes, the amber. I remember when the Black Knight first cast his eyes upon it. In the end it drove him mad!

Ahhh oui, l'ambre. Je me souviens du jour où le chevalier noir l'a vue pour la première fois. Au bout du compte, elle l'a rendu fou !

Oh, sí, el ámbar. Recuerdo cuando el Caballero Negro le puso la mirada encima por primera vez. ¡Acabó perdiendo la cabeza!

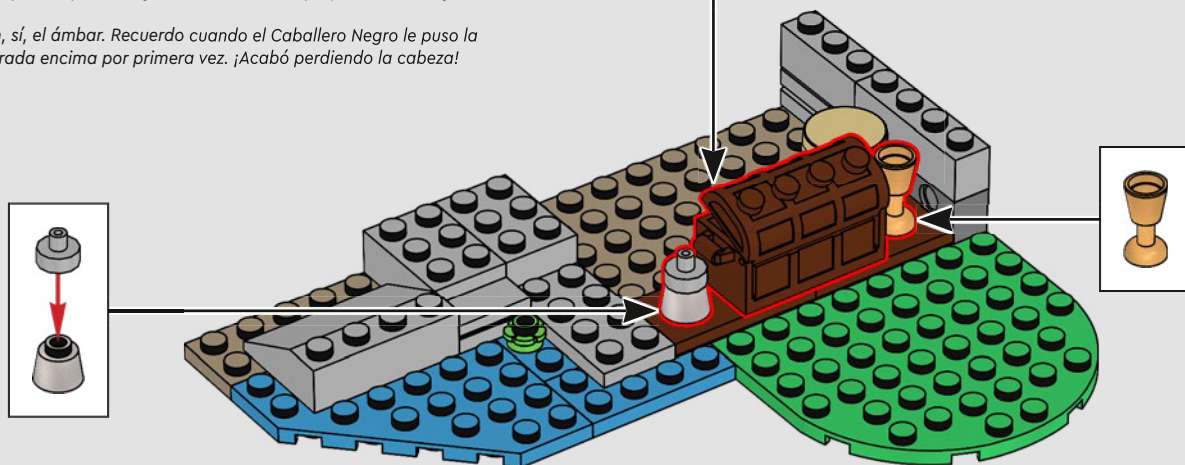

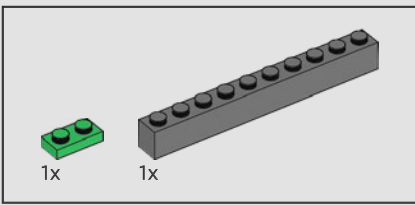

316

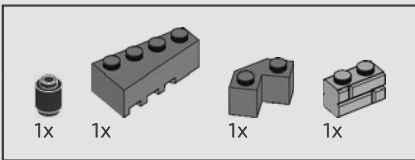
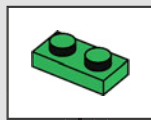
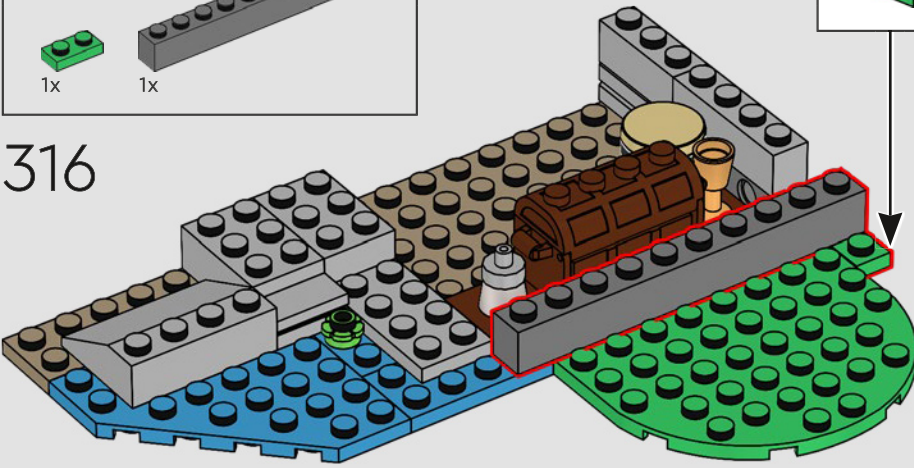

317

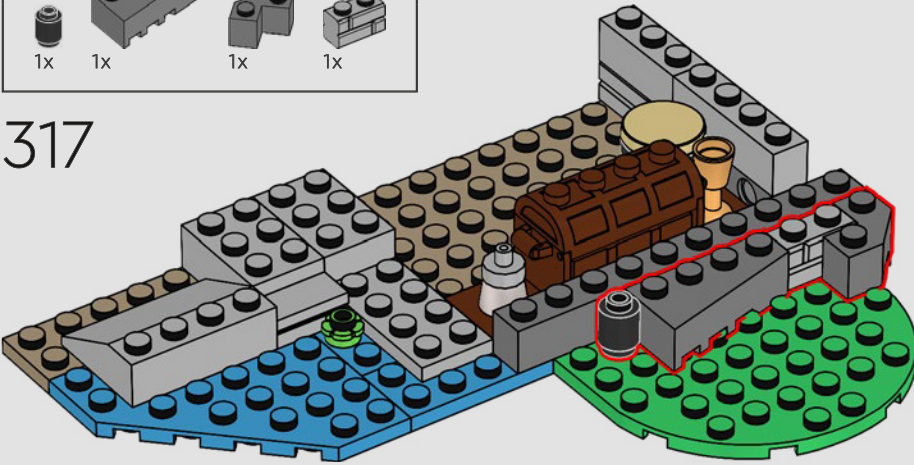

318

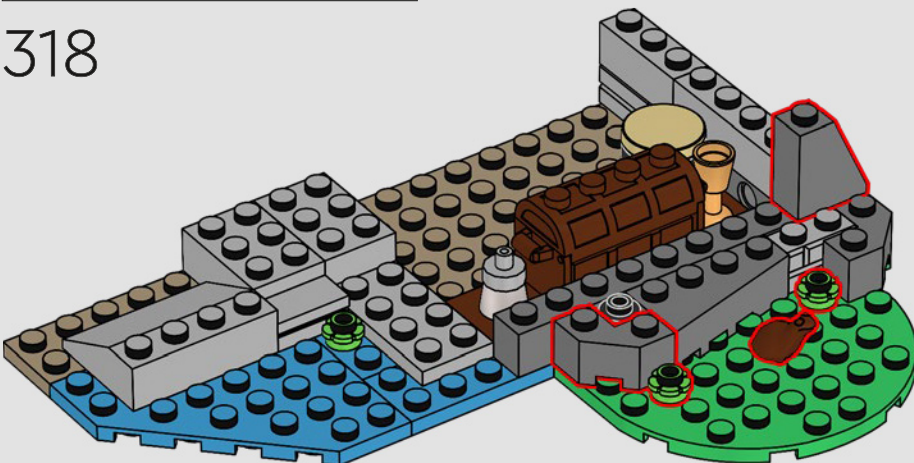

A brown frog? I wonder if he was always that lovely color...

Une grenouille brune ? Je me demande si elle a toujours été de cette jolie couleur...

¿Una rana café? Me pregunto si siempre fue de ese hermoso color.

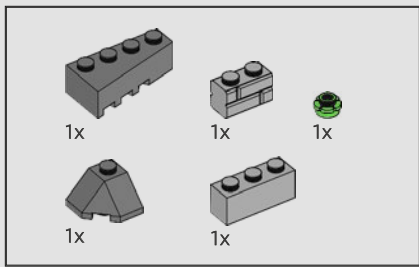

319

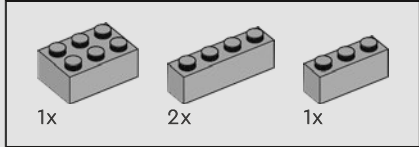
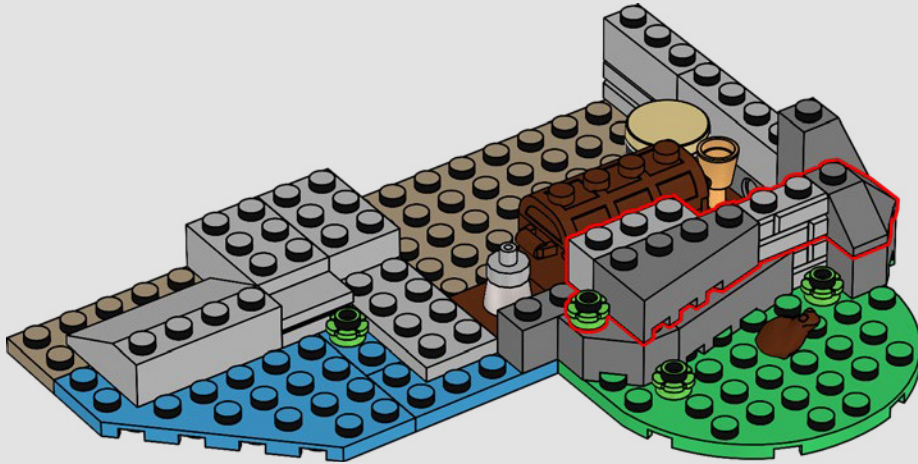

320

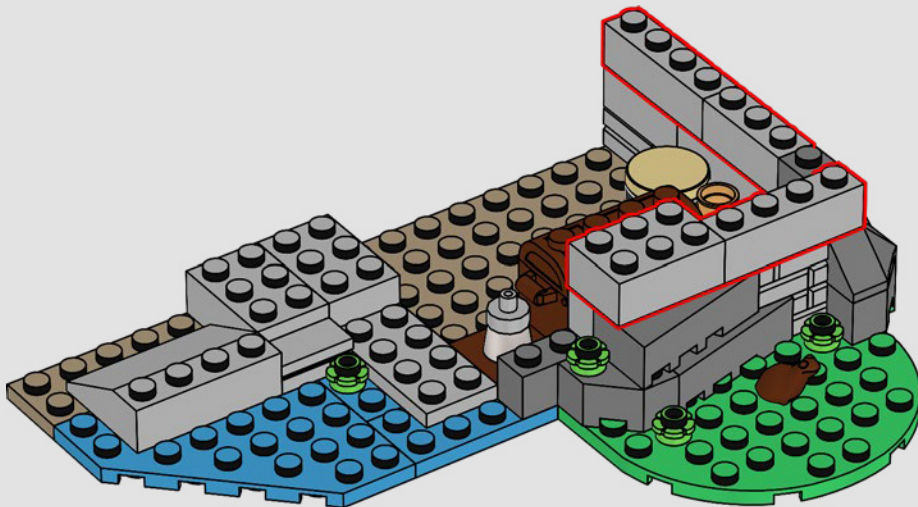

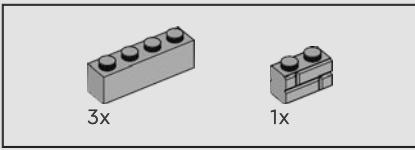

321

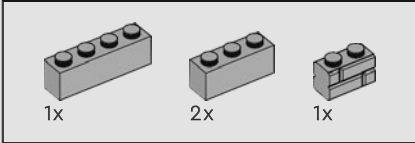
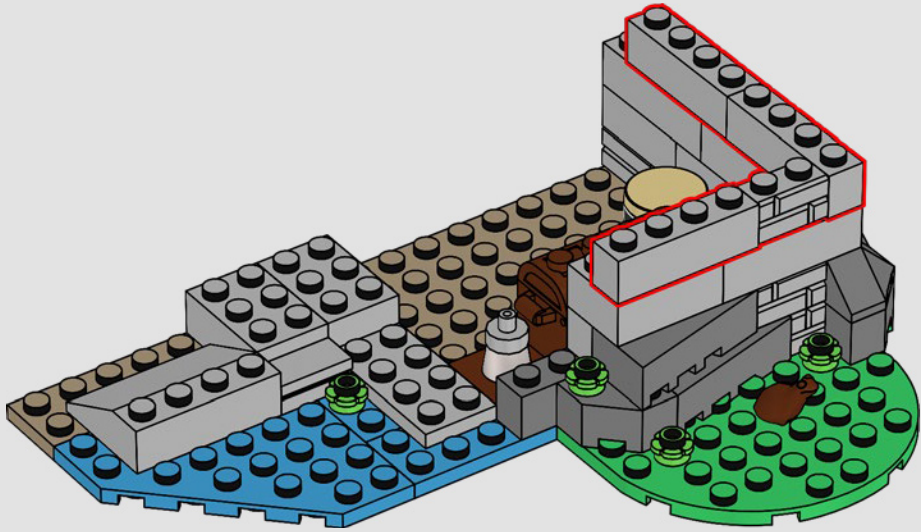

322

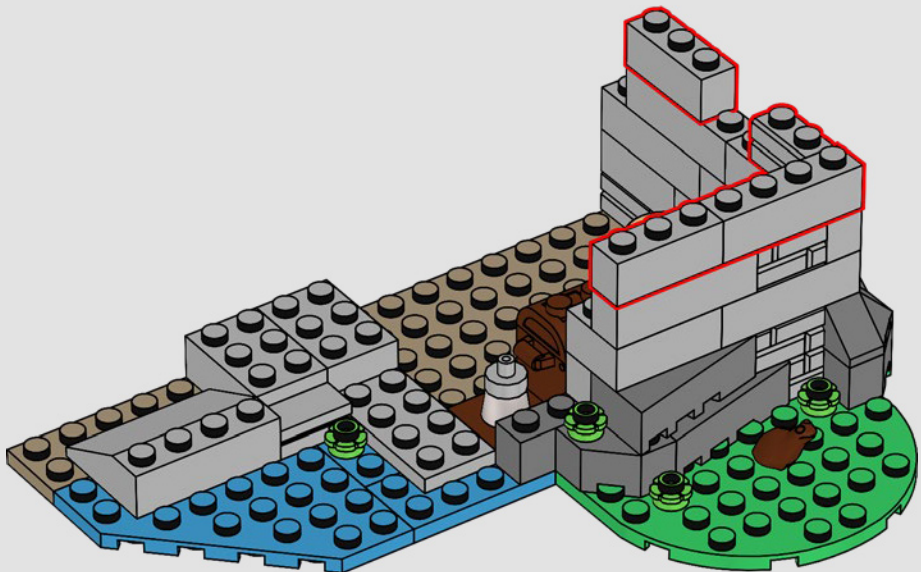

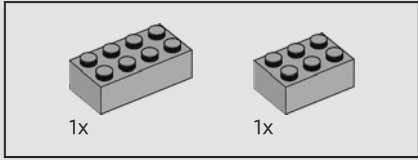
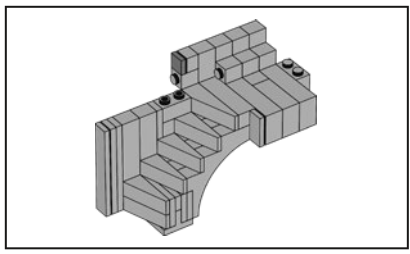

323

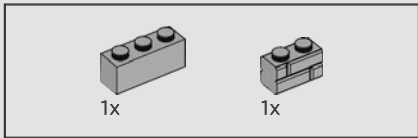
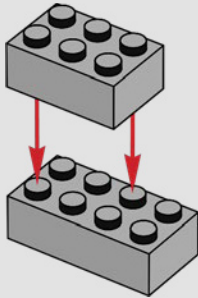

324

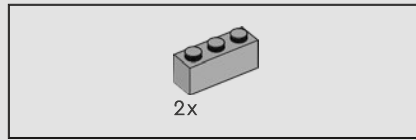
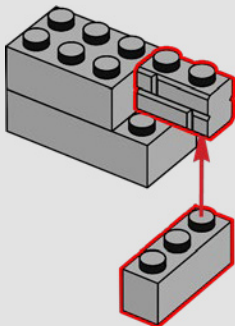

325

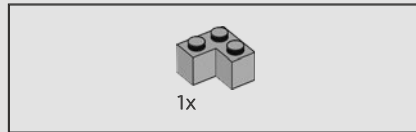
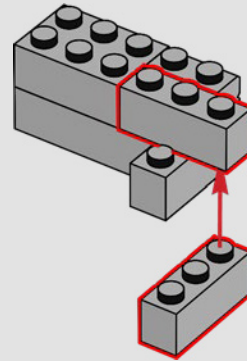

326

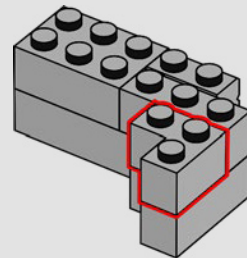

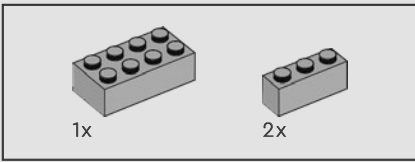

327

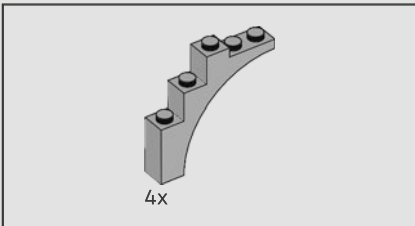
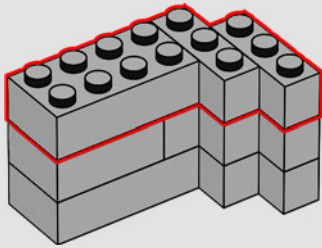

328

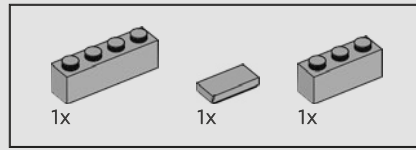
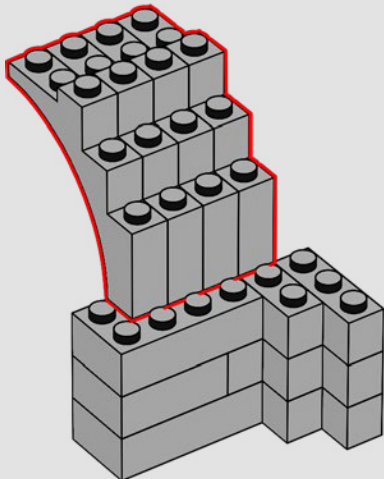

329

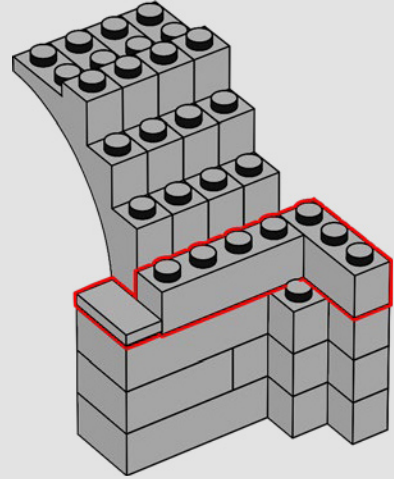

330

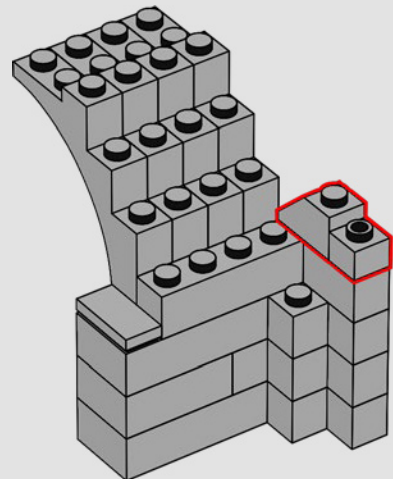

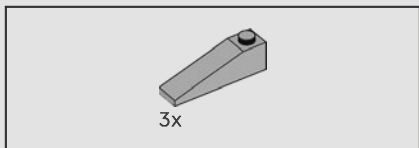

331

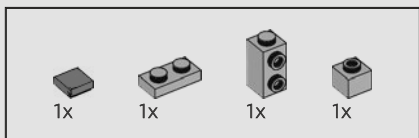
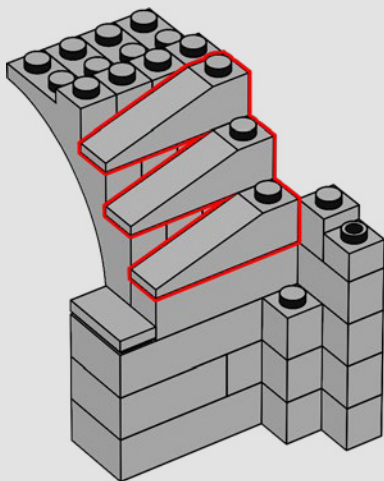

332

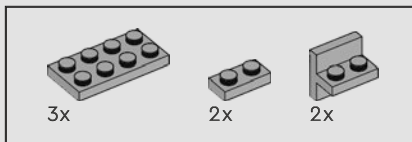
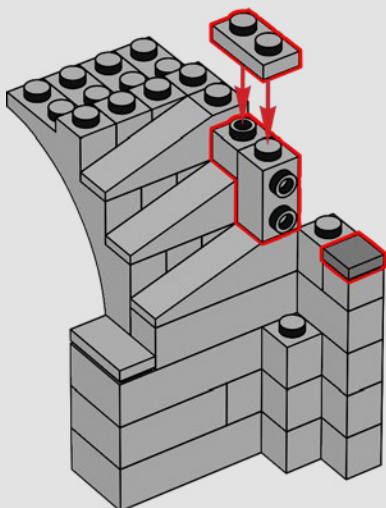

333

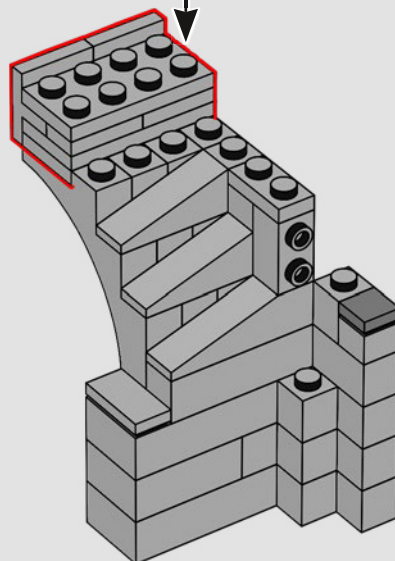
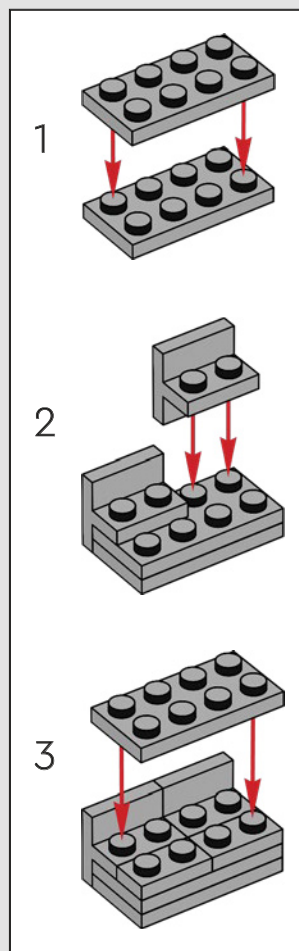

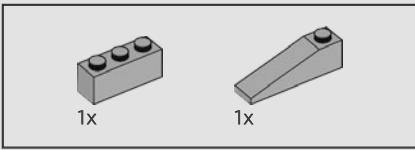

334

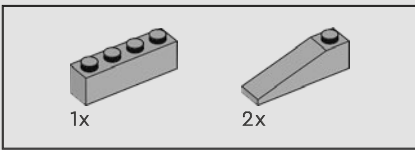
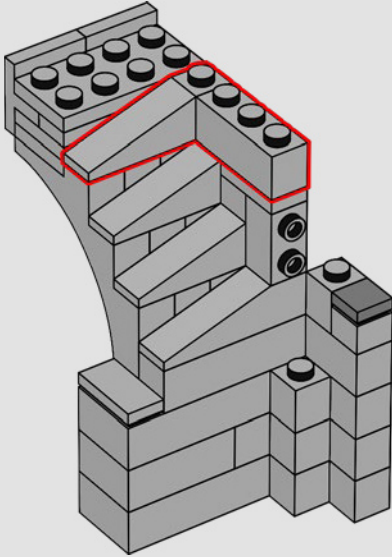

335

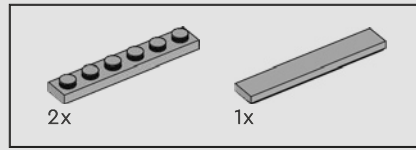
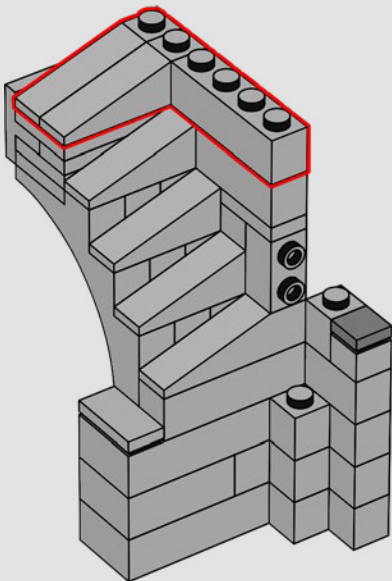

336

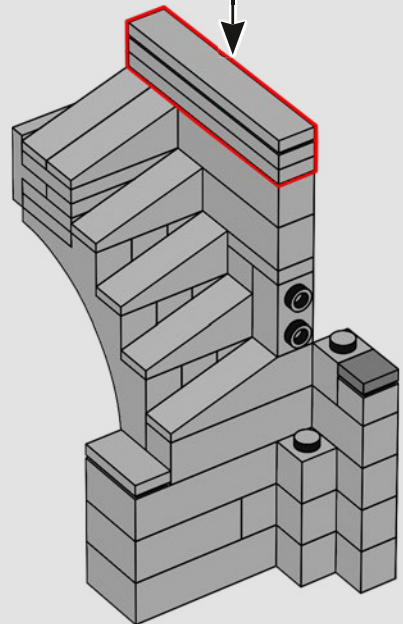
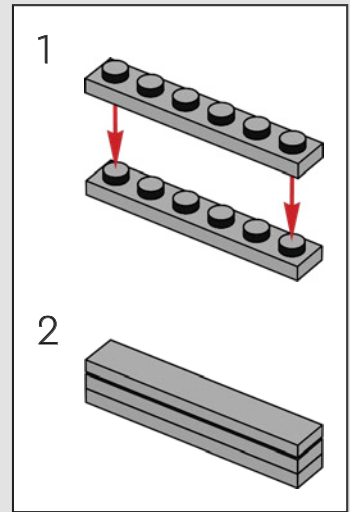

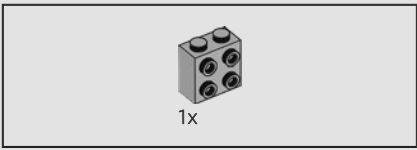

337

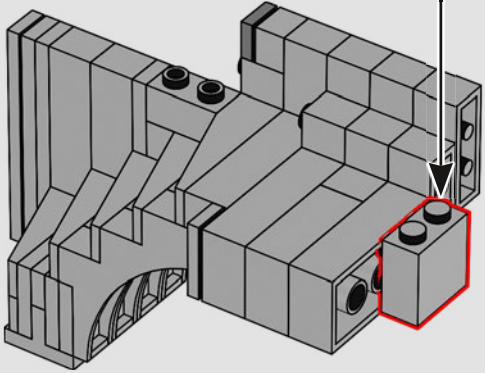
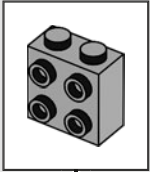

338

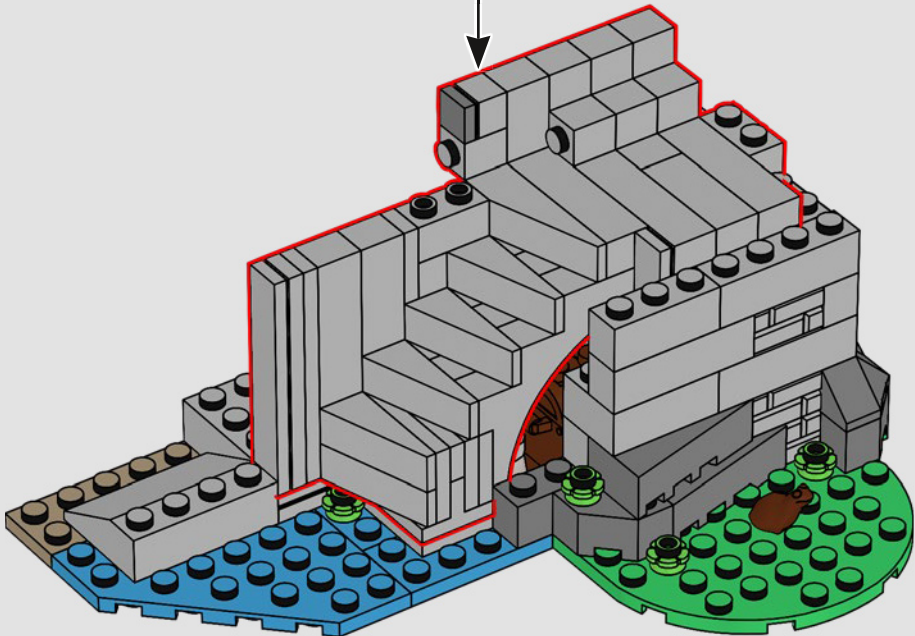

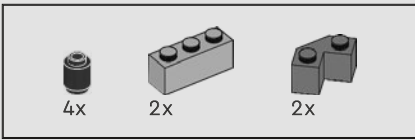

339

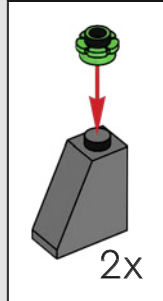
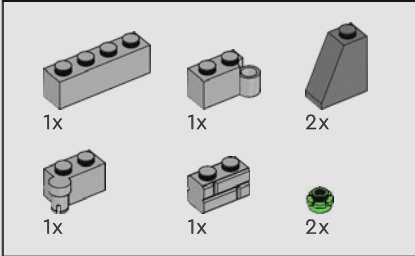
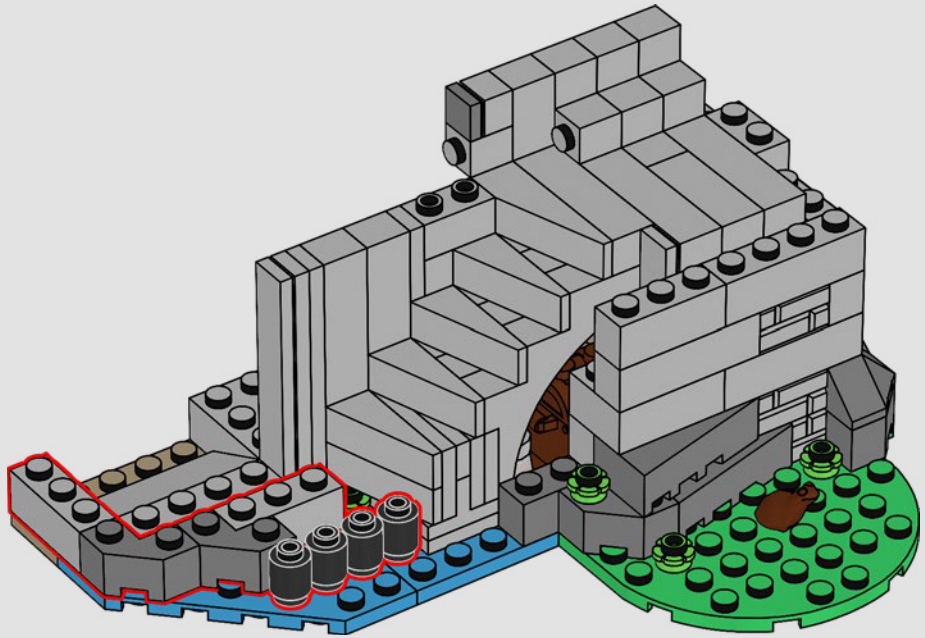

340

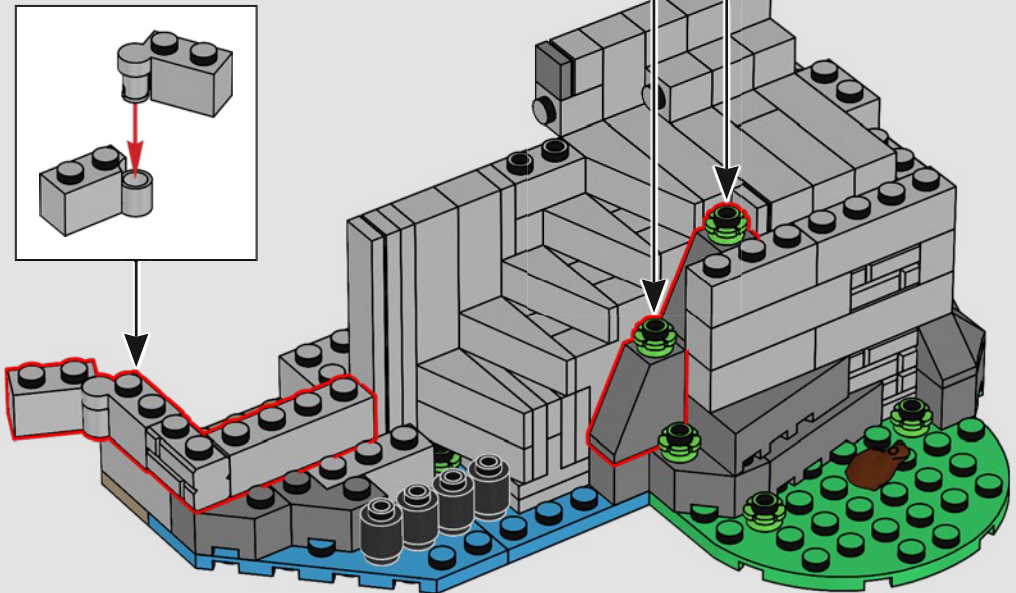

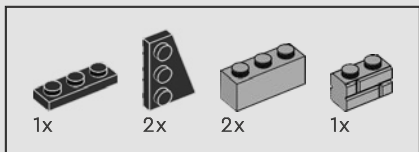

341

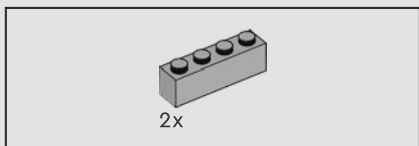
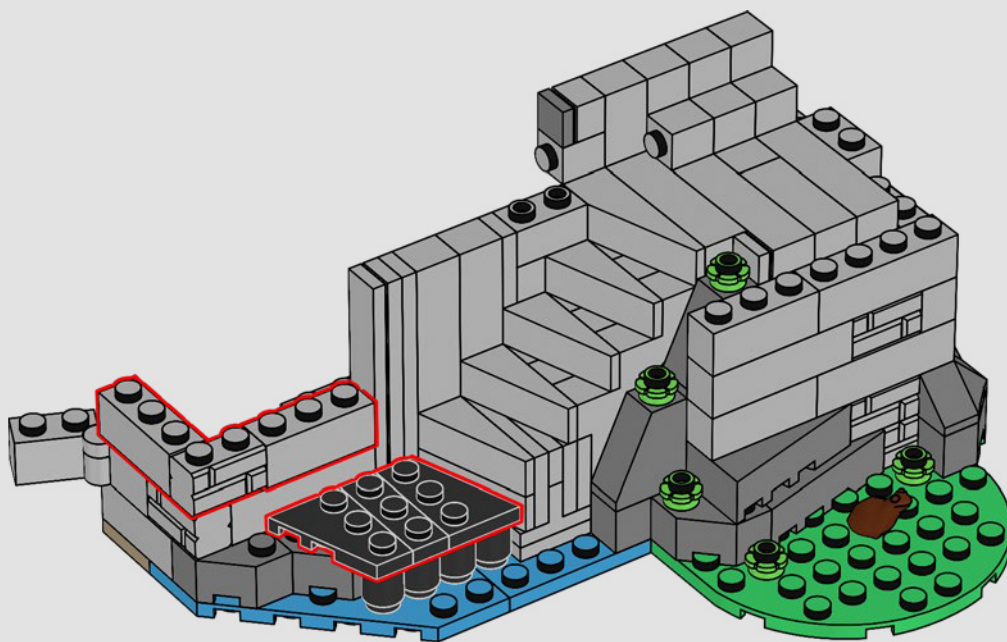

342

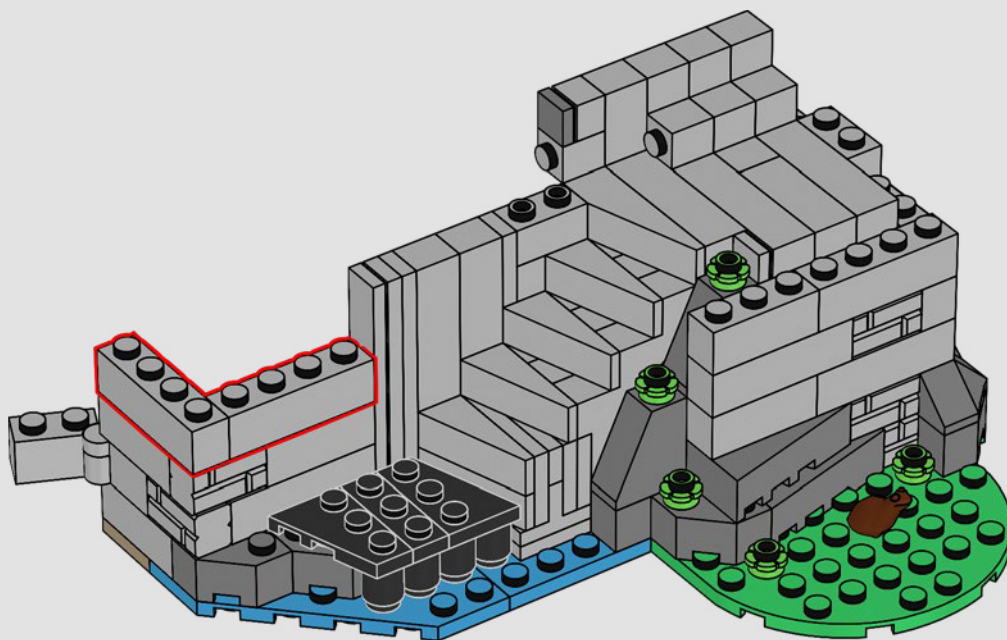

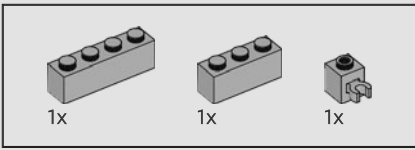

343

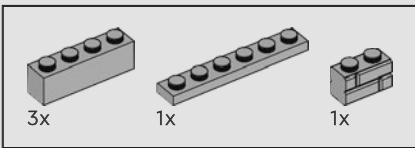
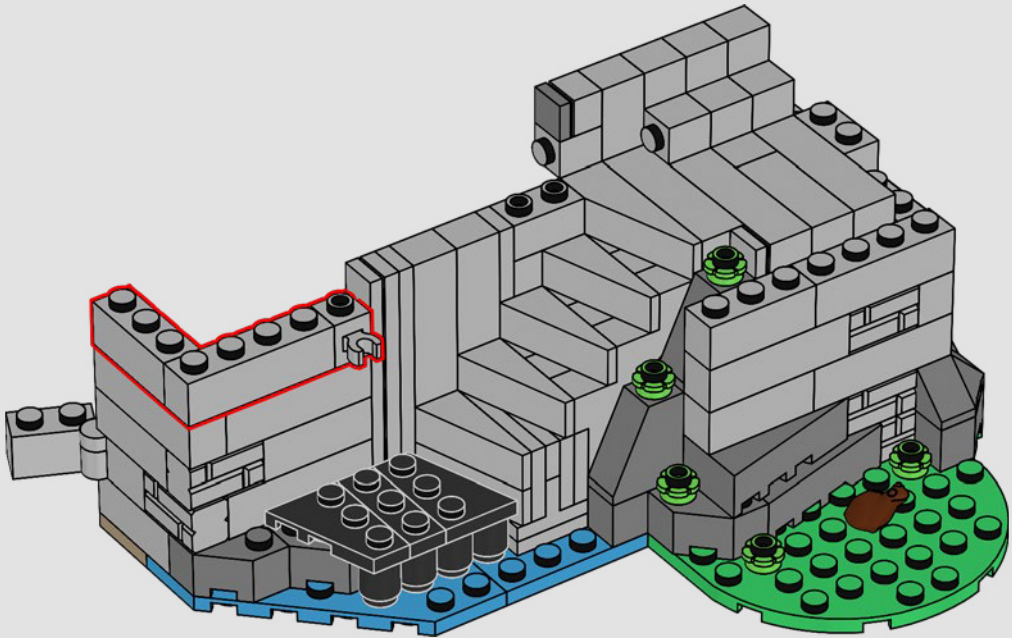

344

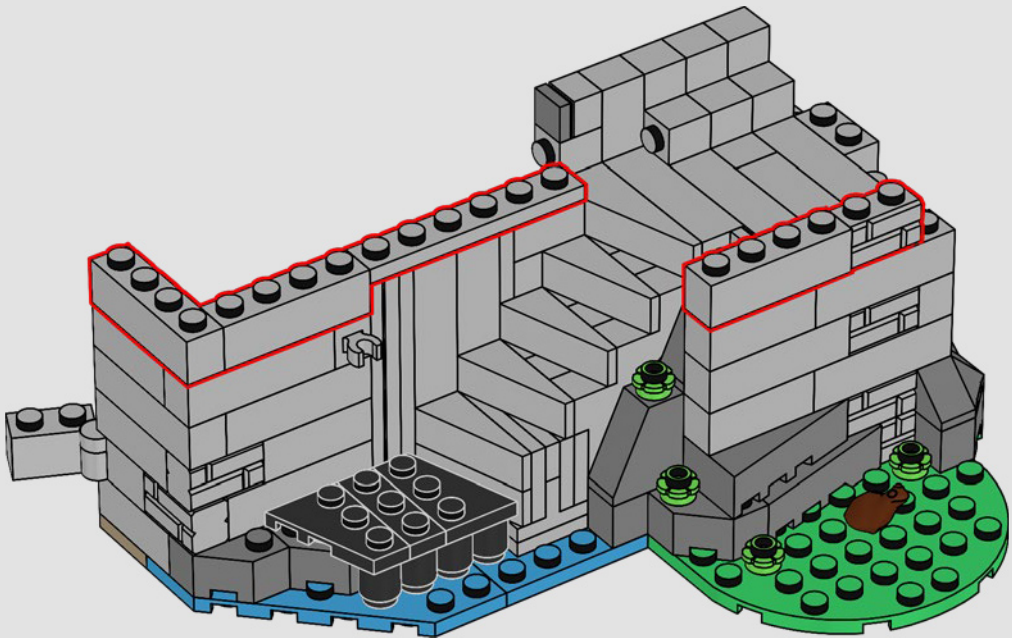

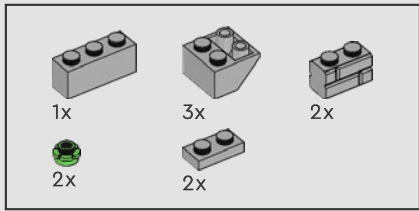

345

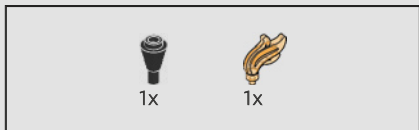
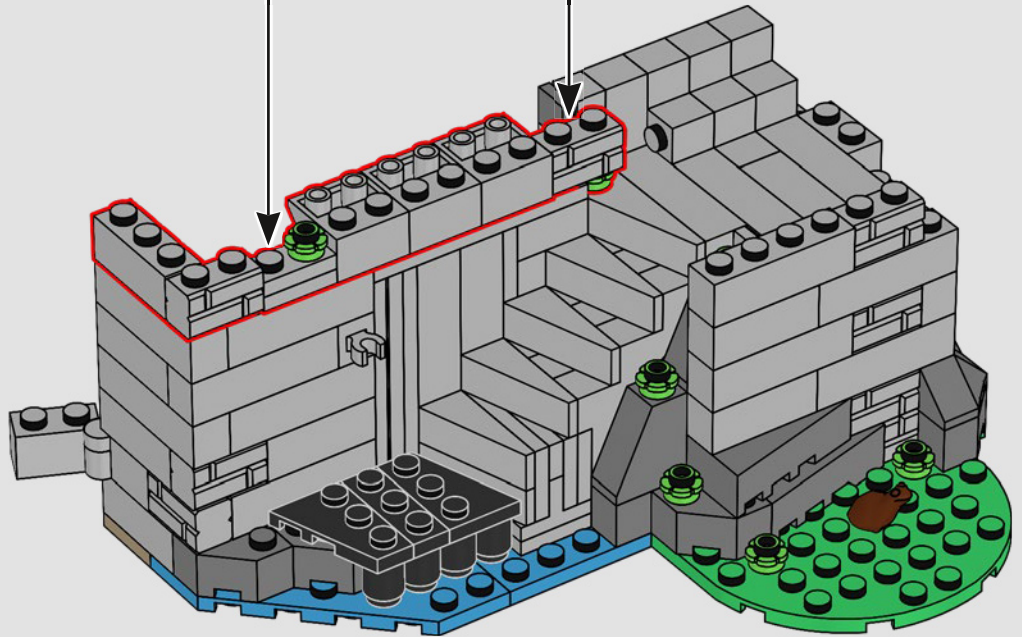
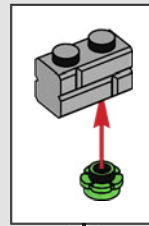
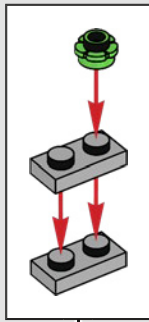

346

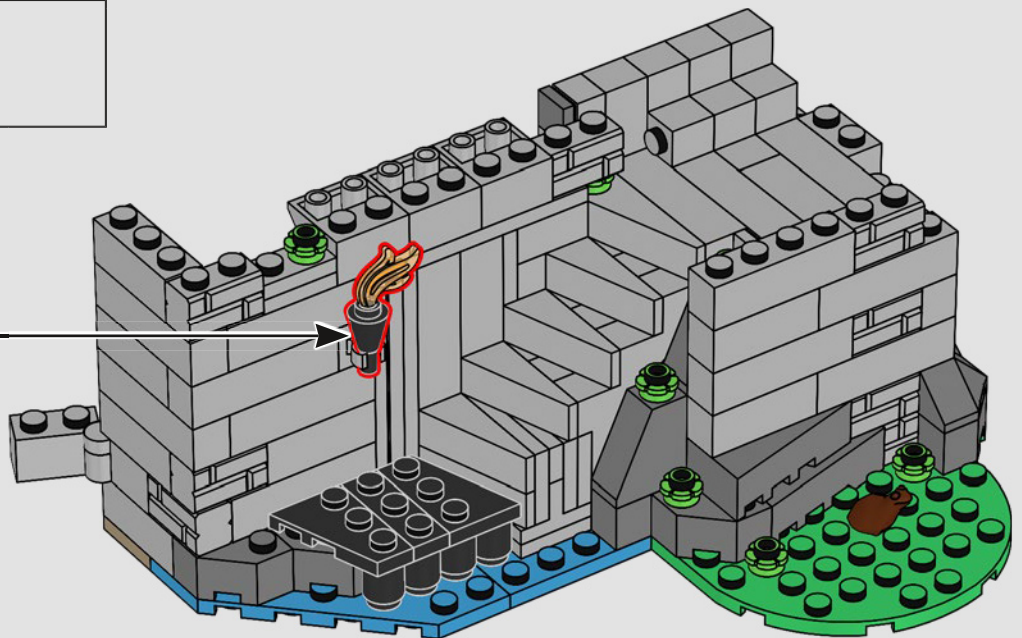
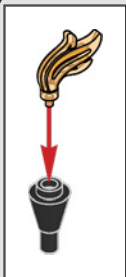

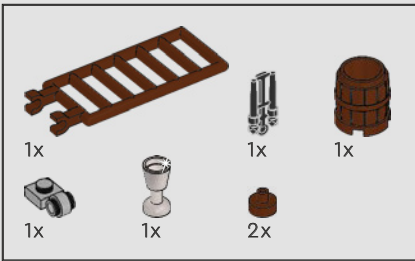

347

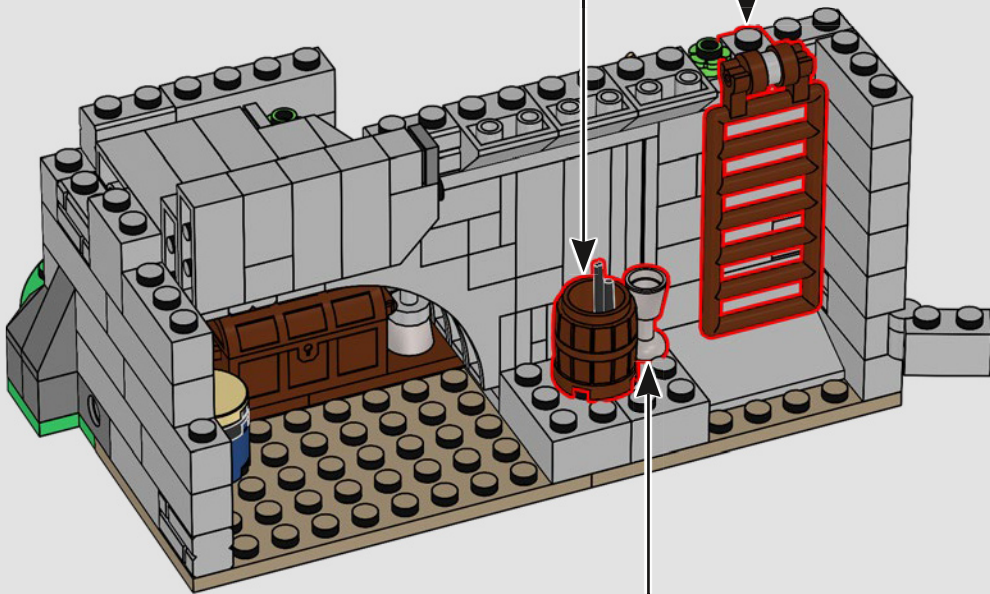
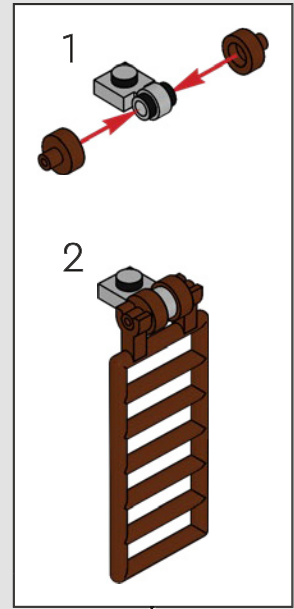
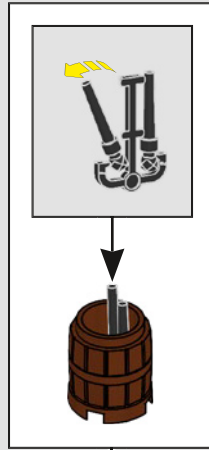

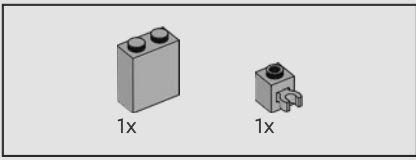

348

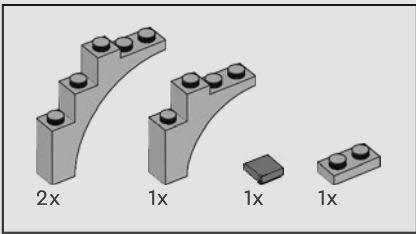
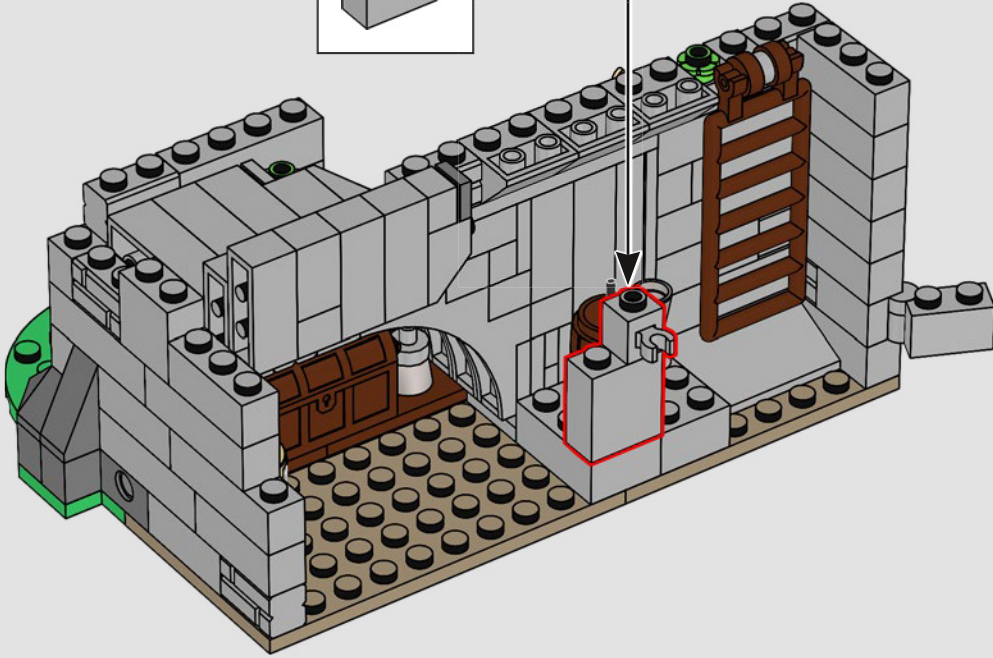
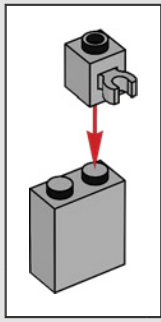

349

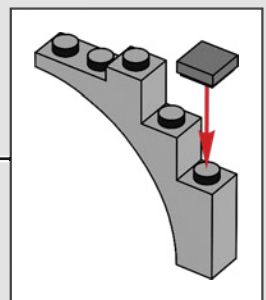
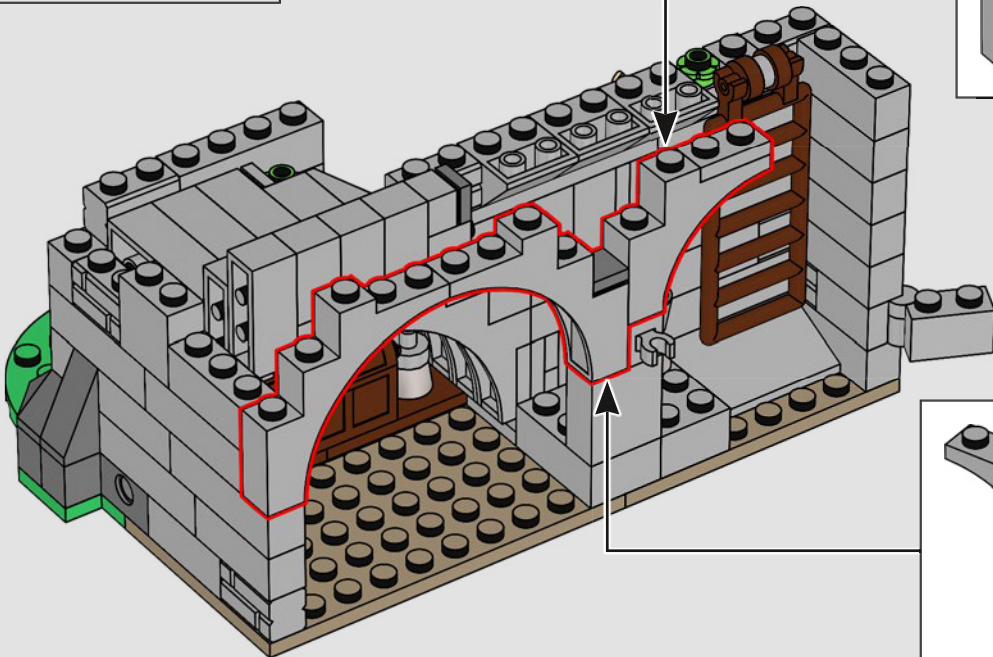
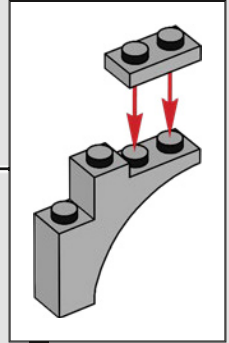

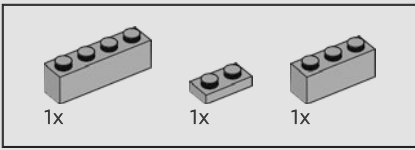

350

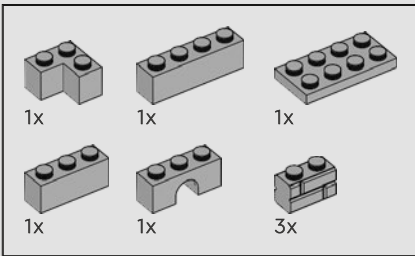
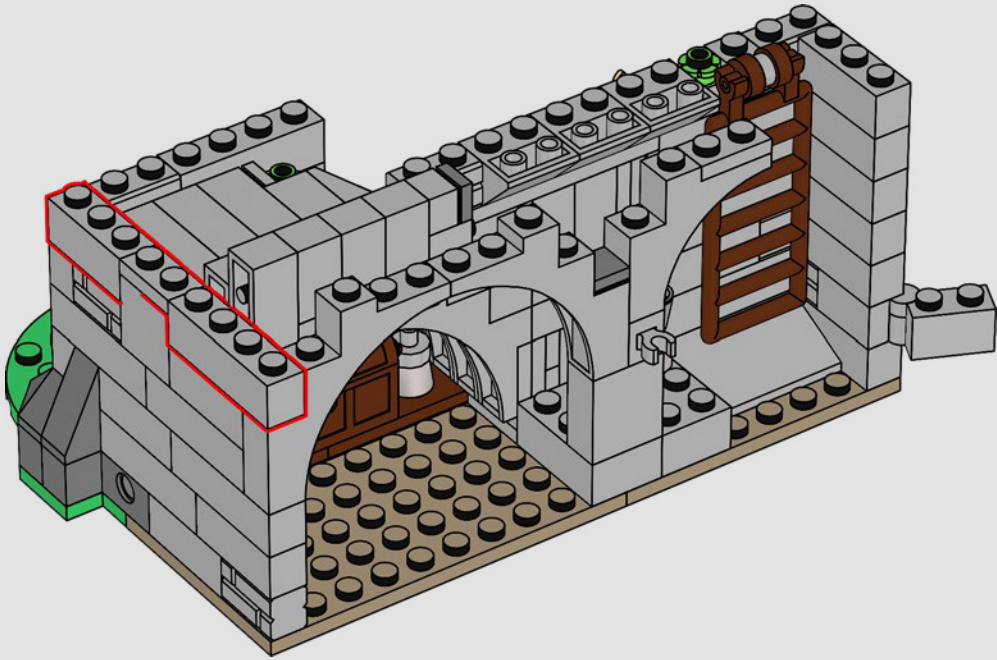

351

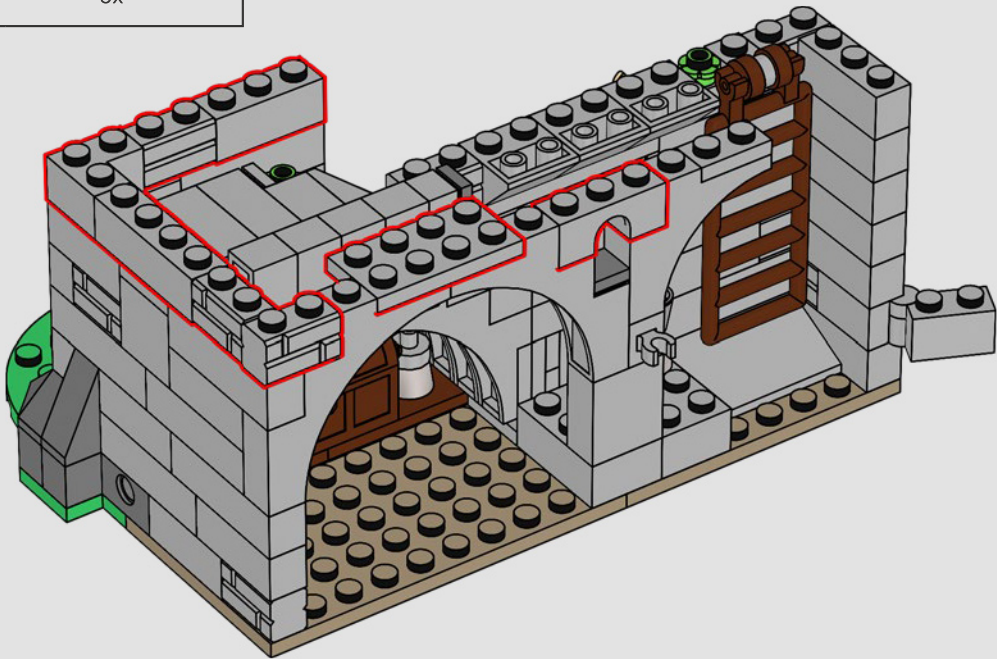

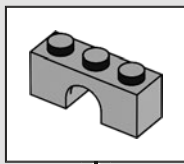
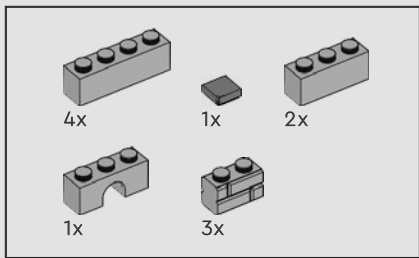

352

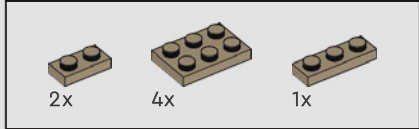
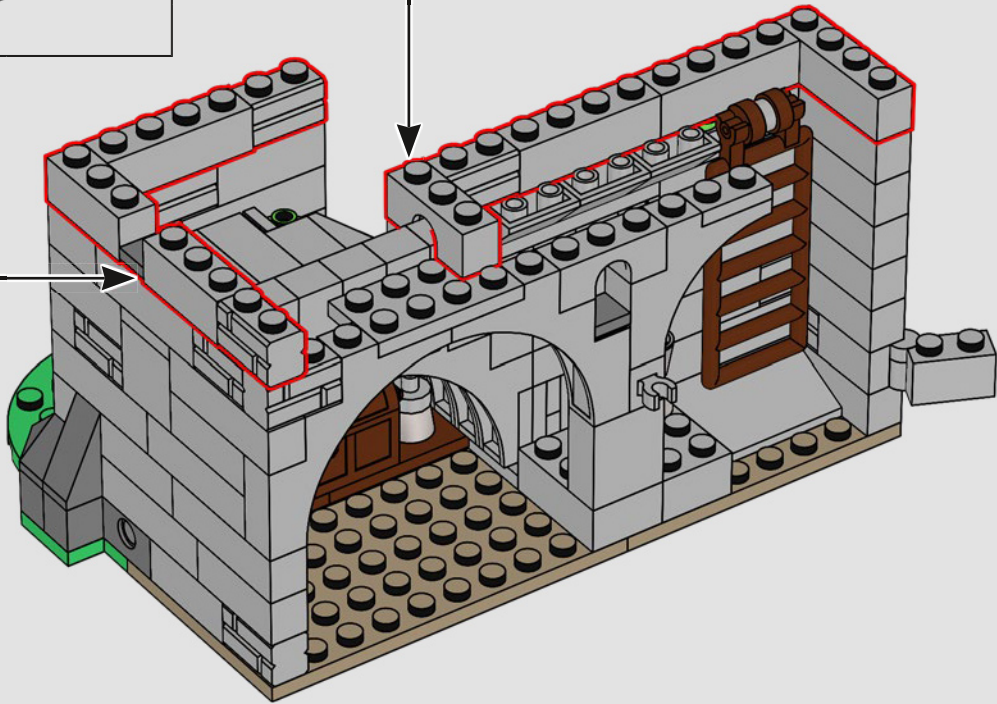
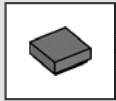

353

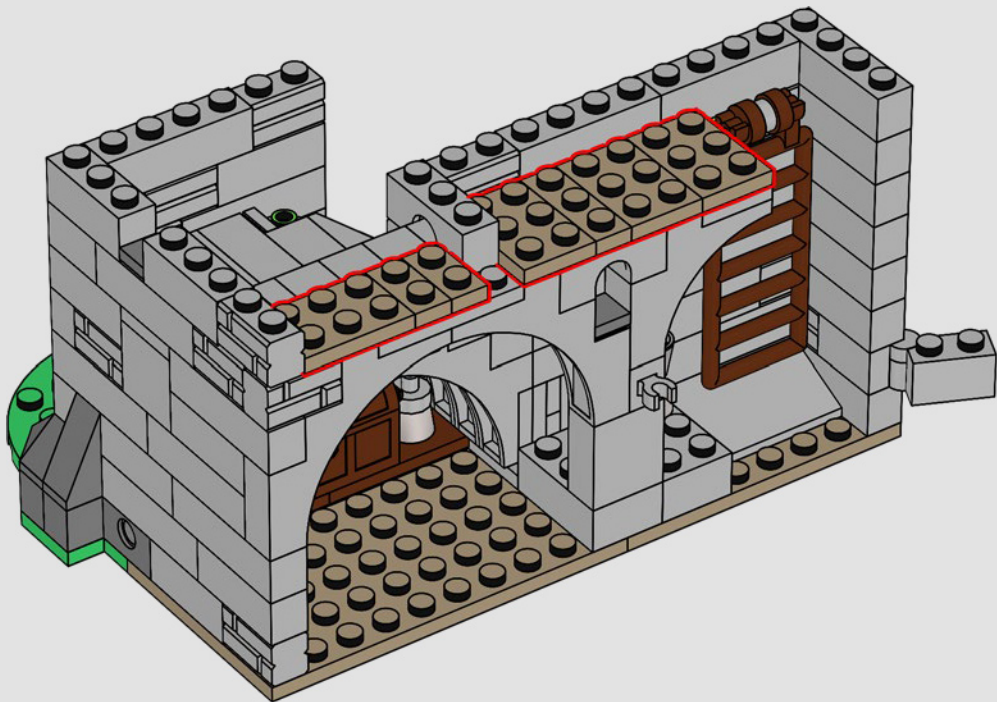

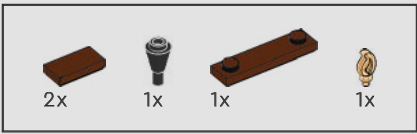

354

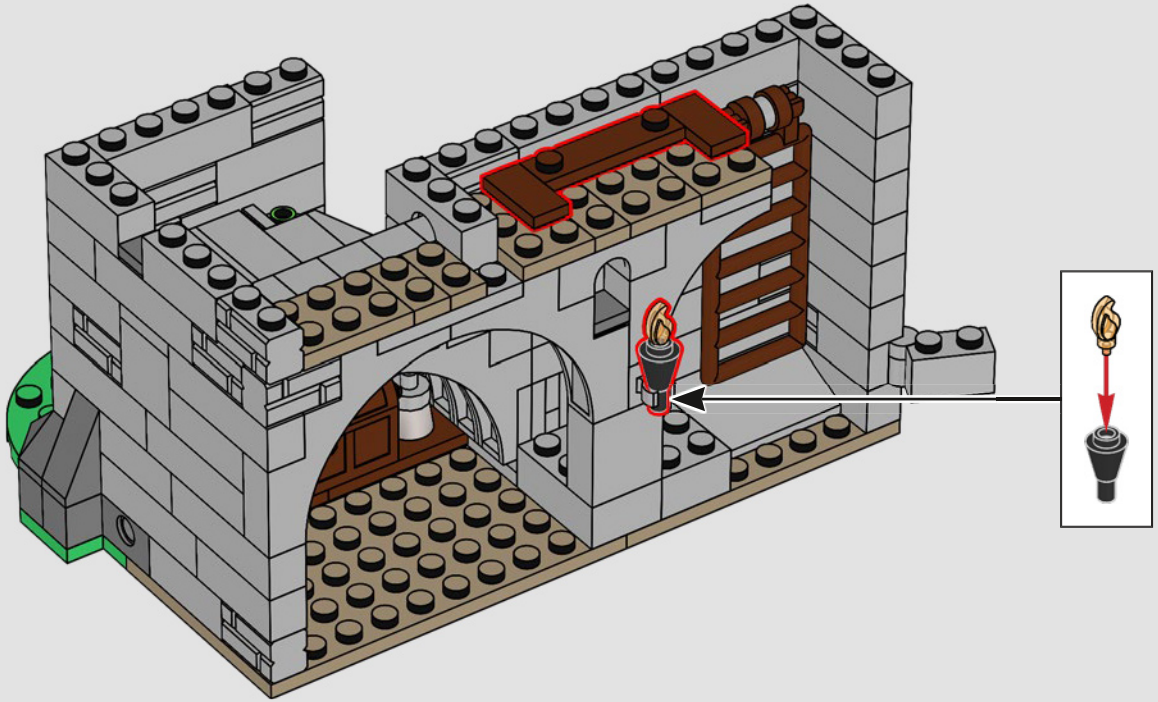

355

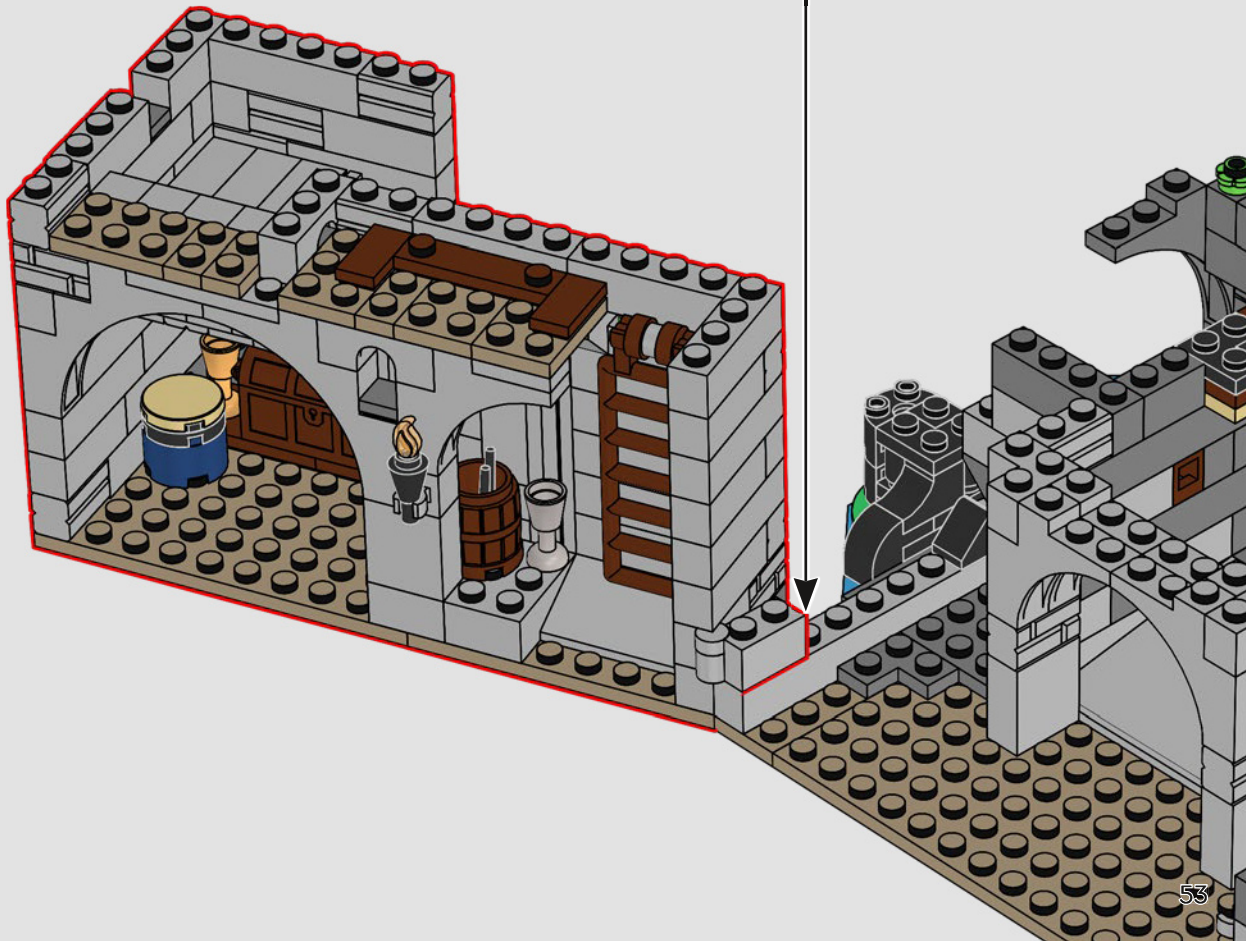

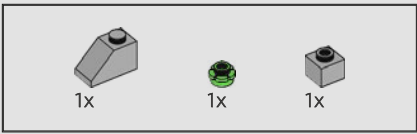

356

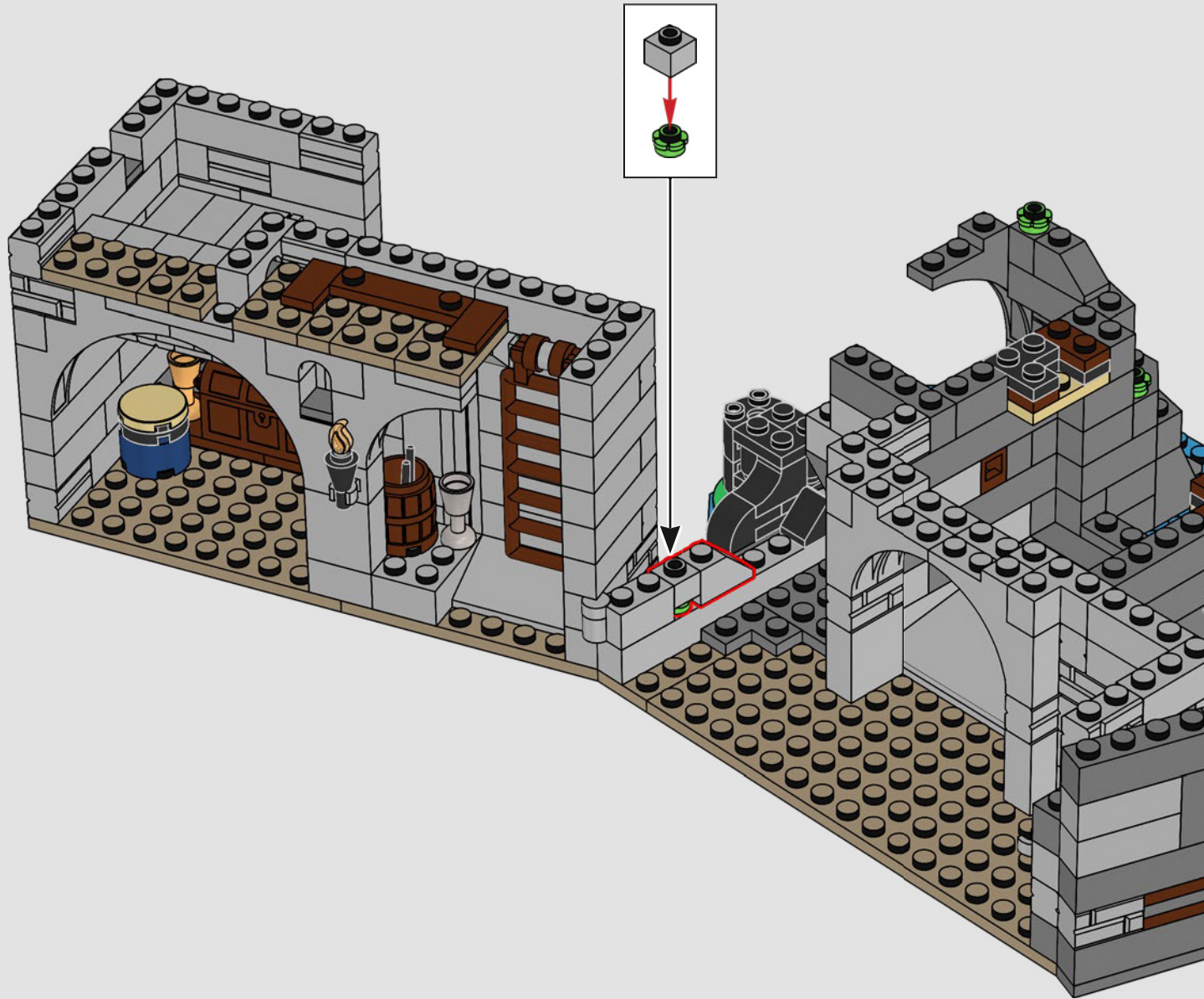

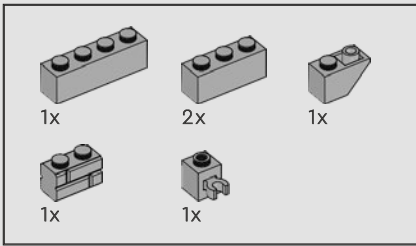

357

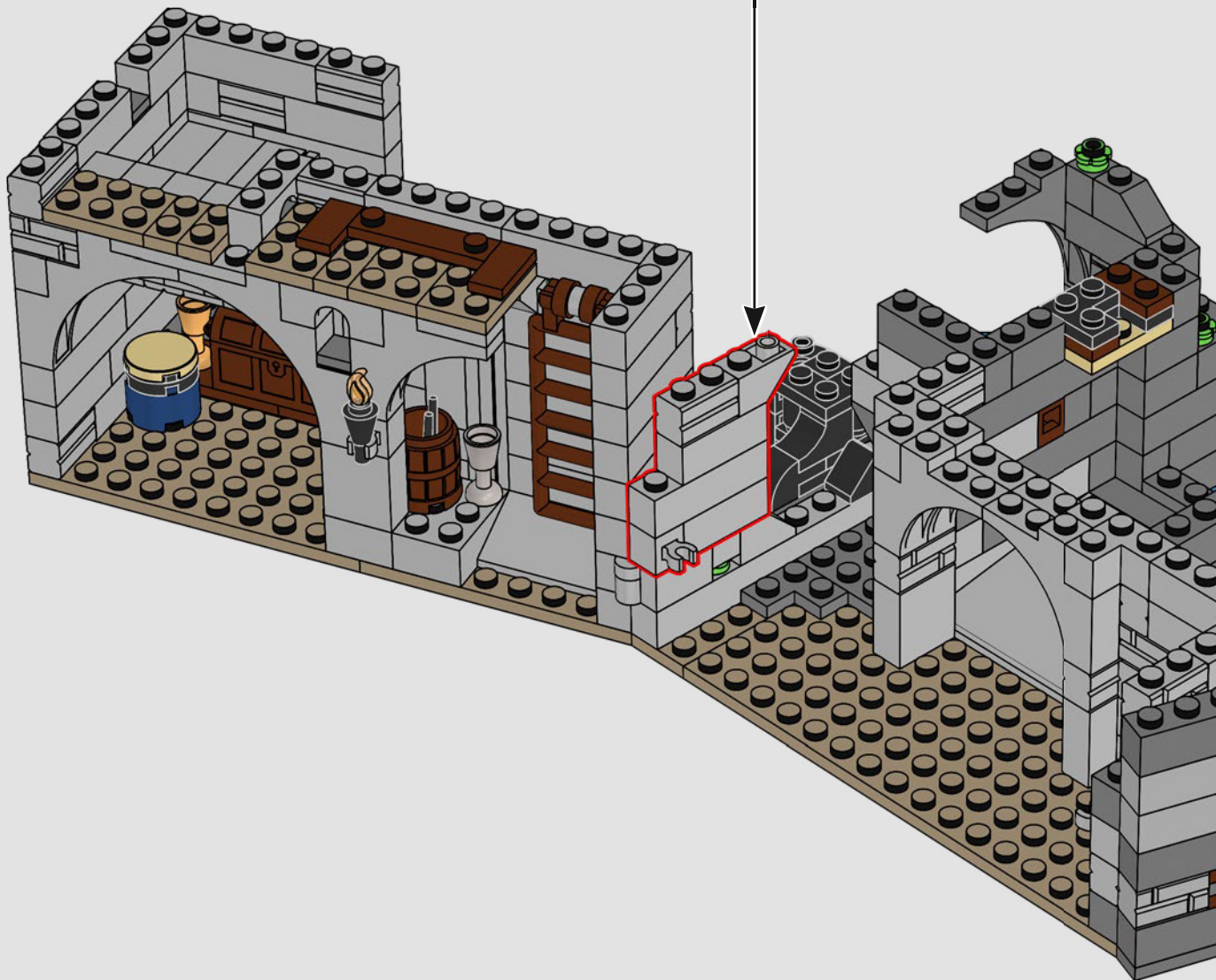
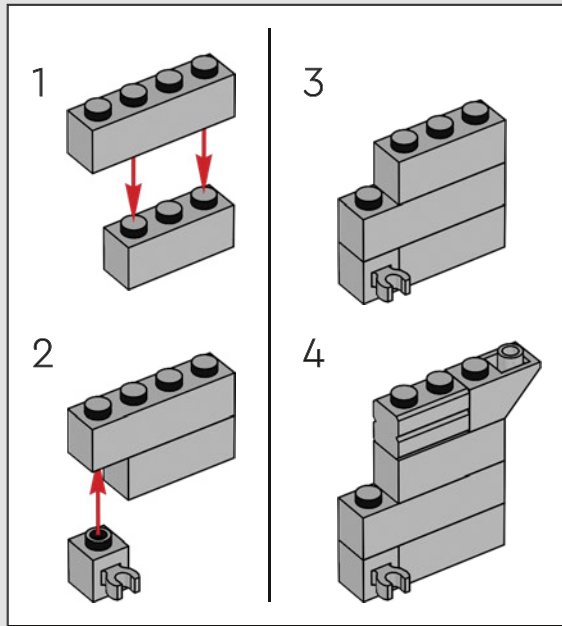

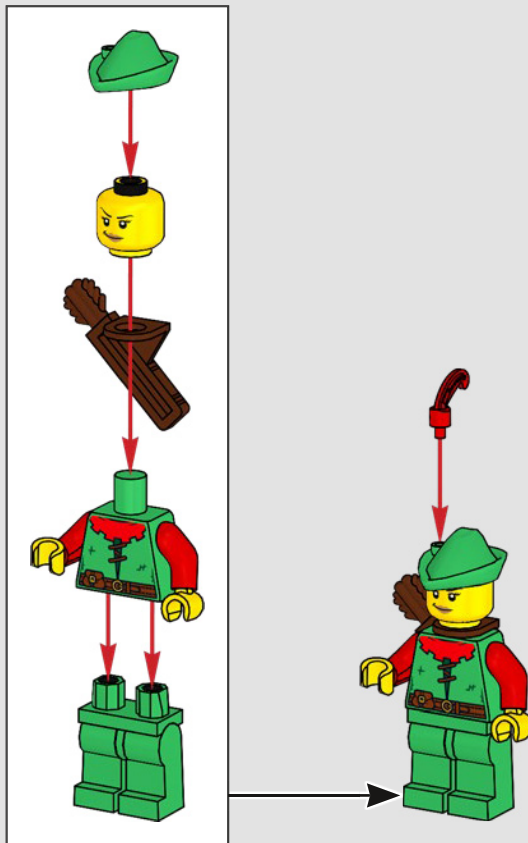

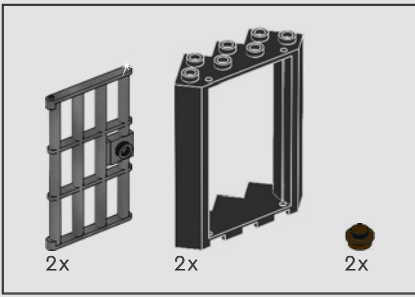

358

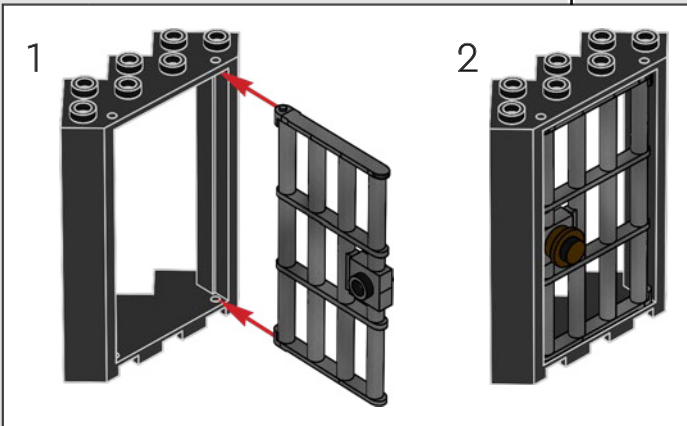
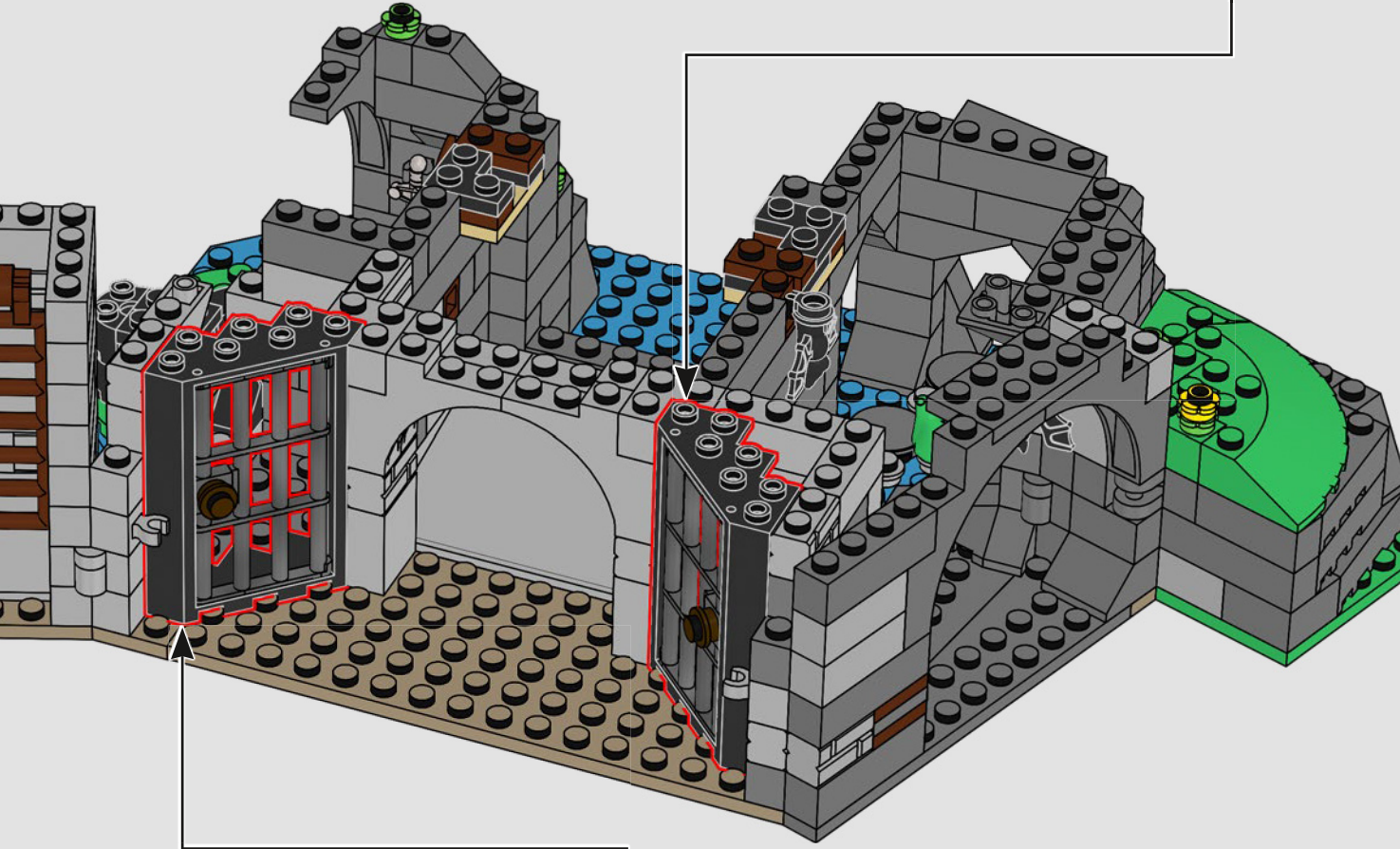
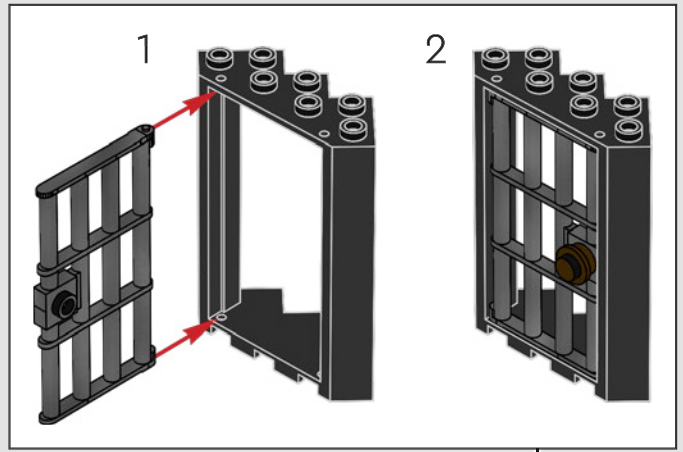

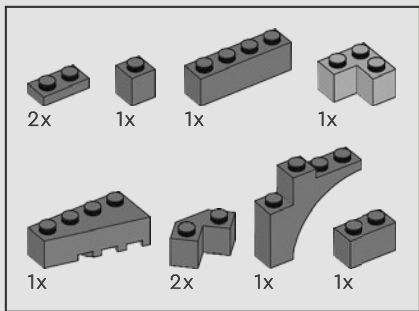

359

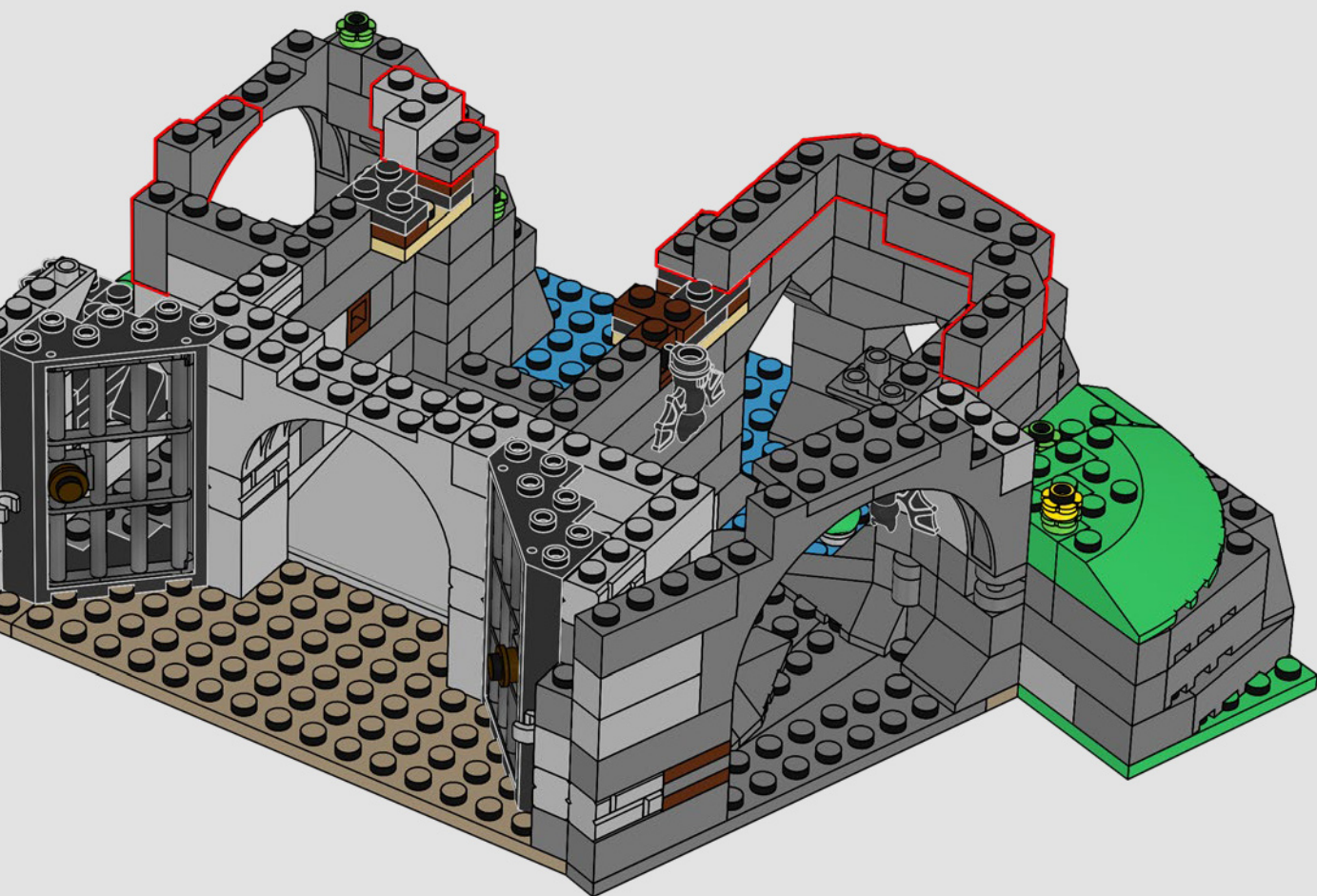

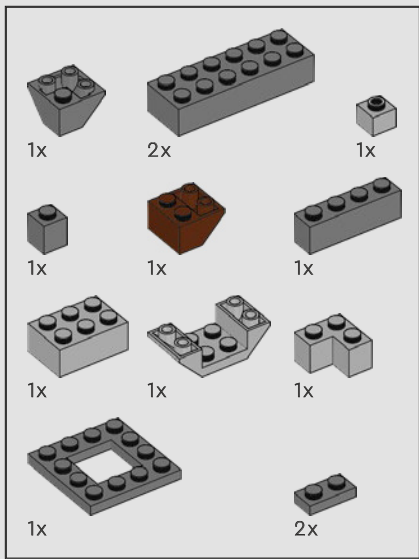

361

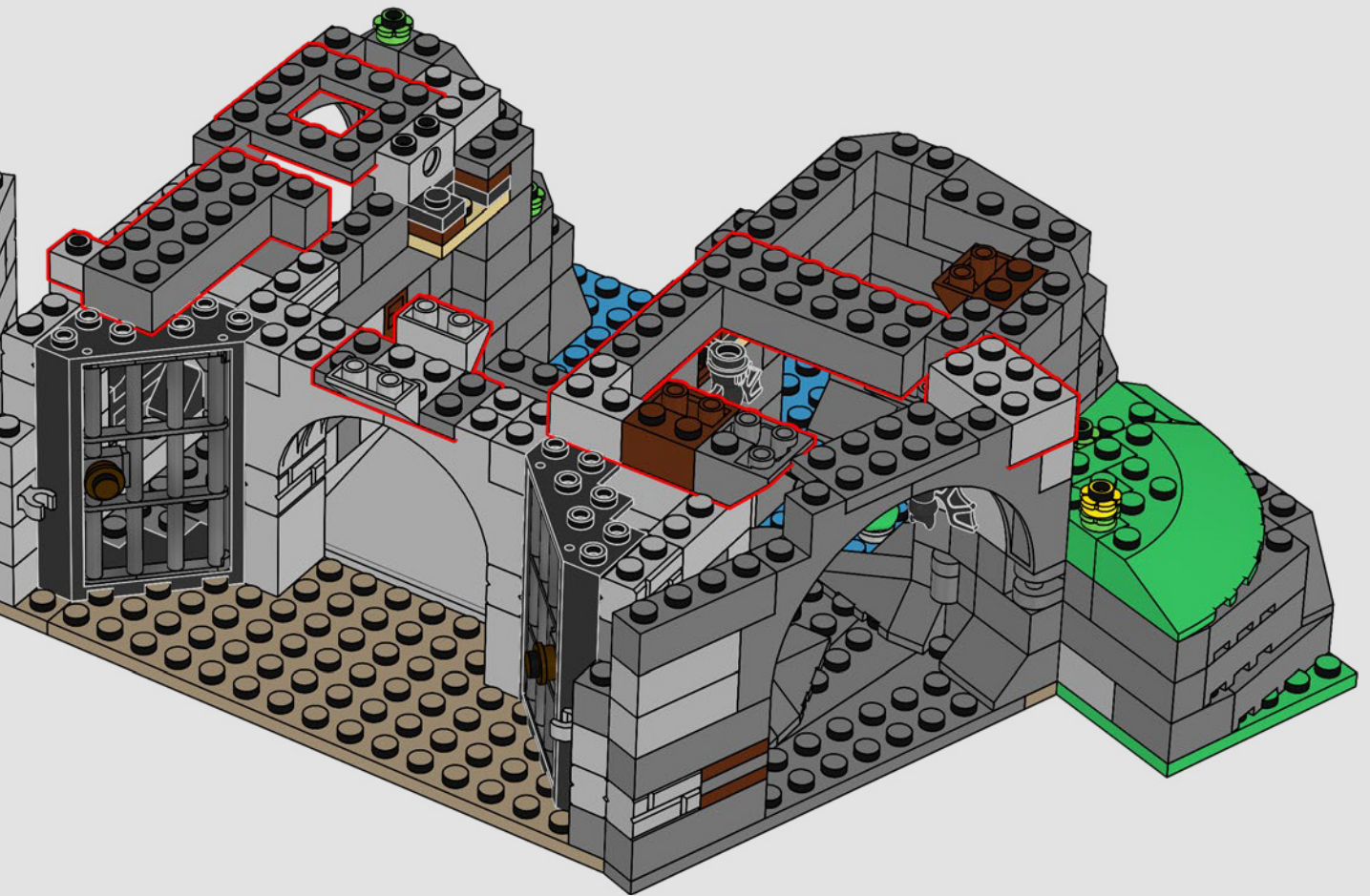

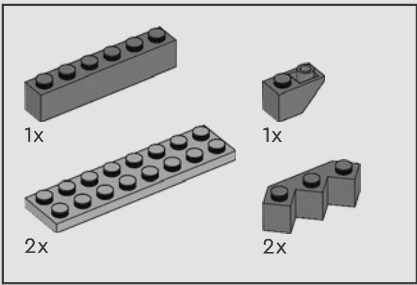

362

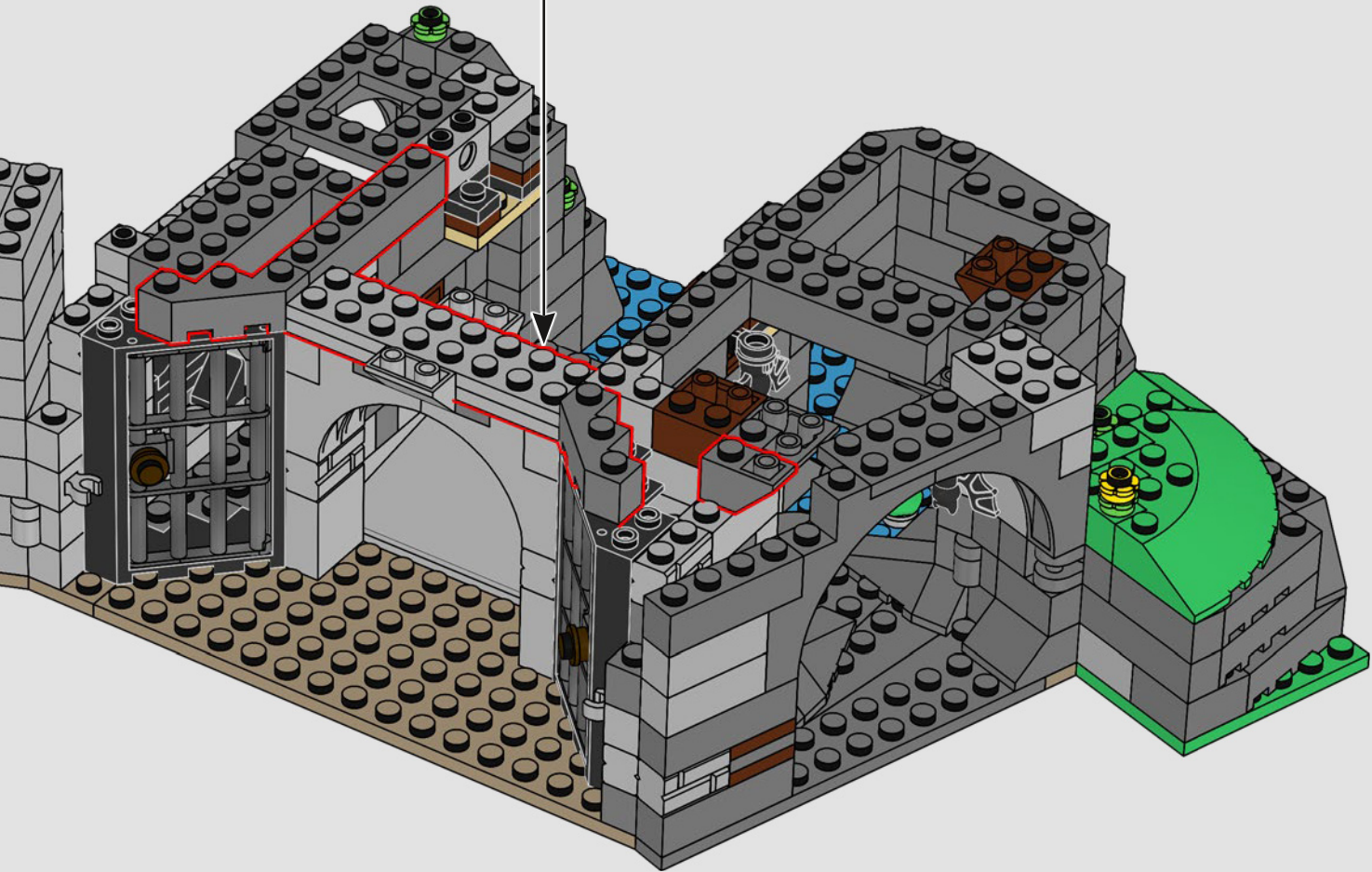
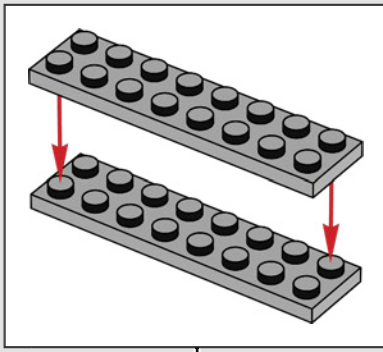

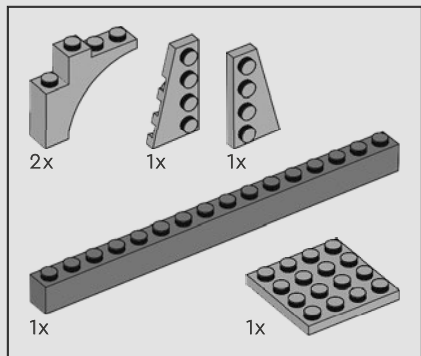

363

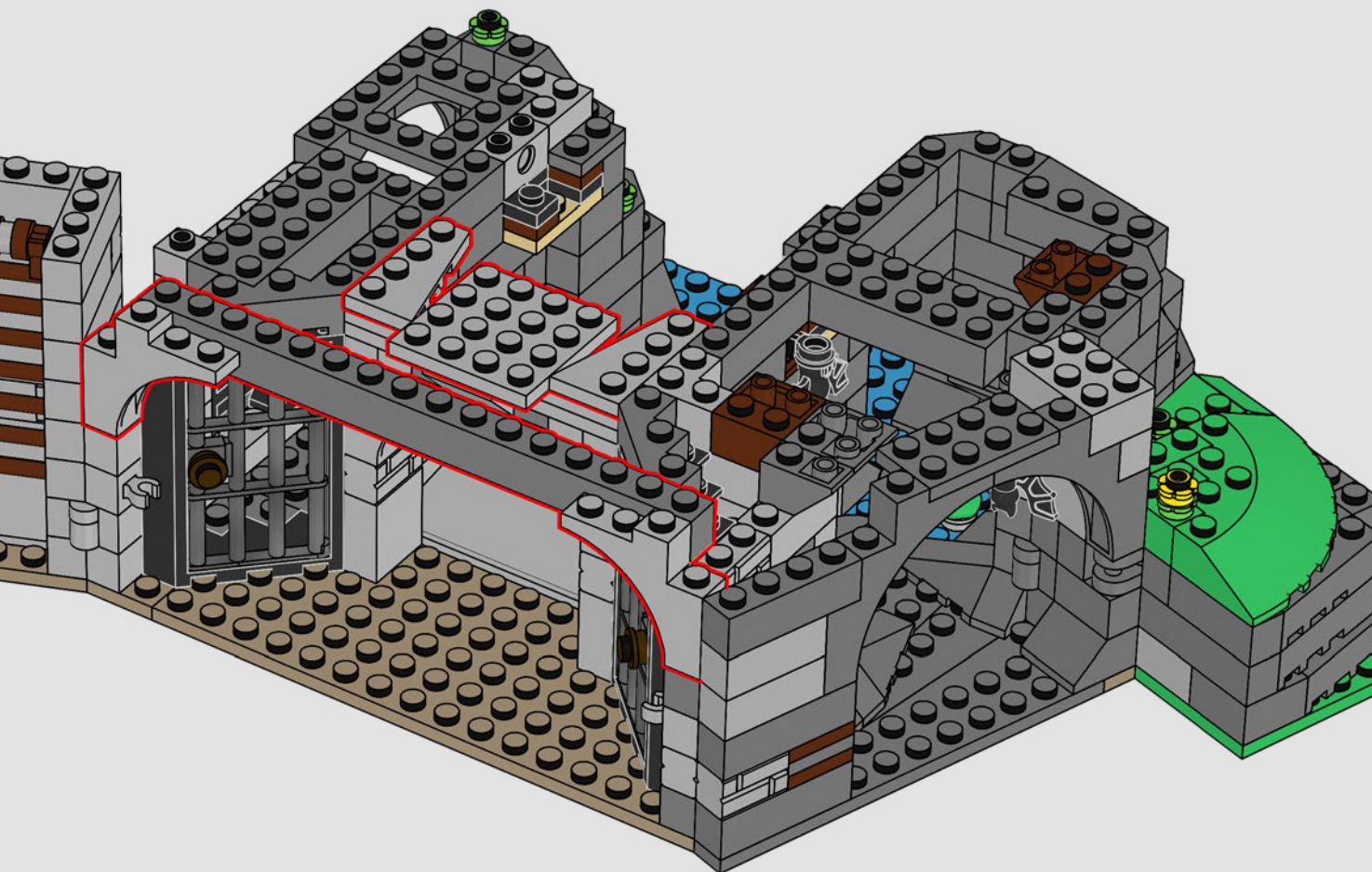

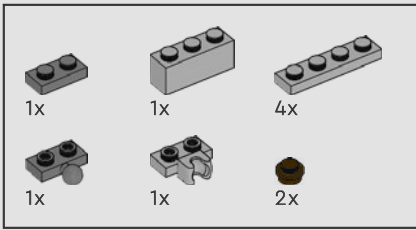

364

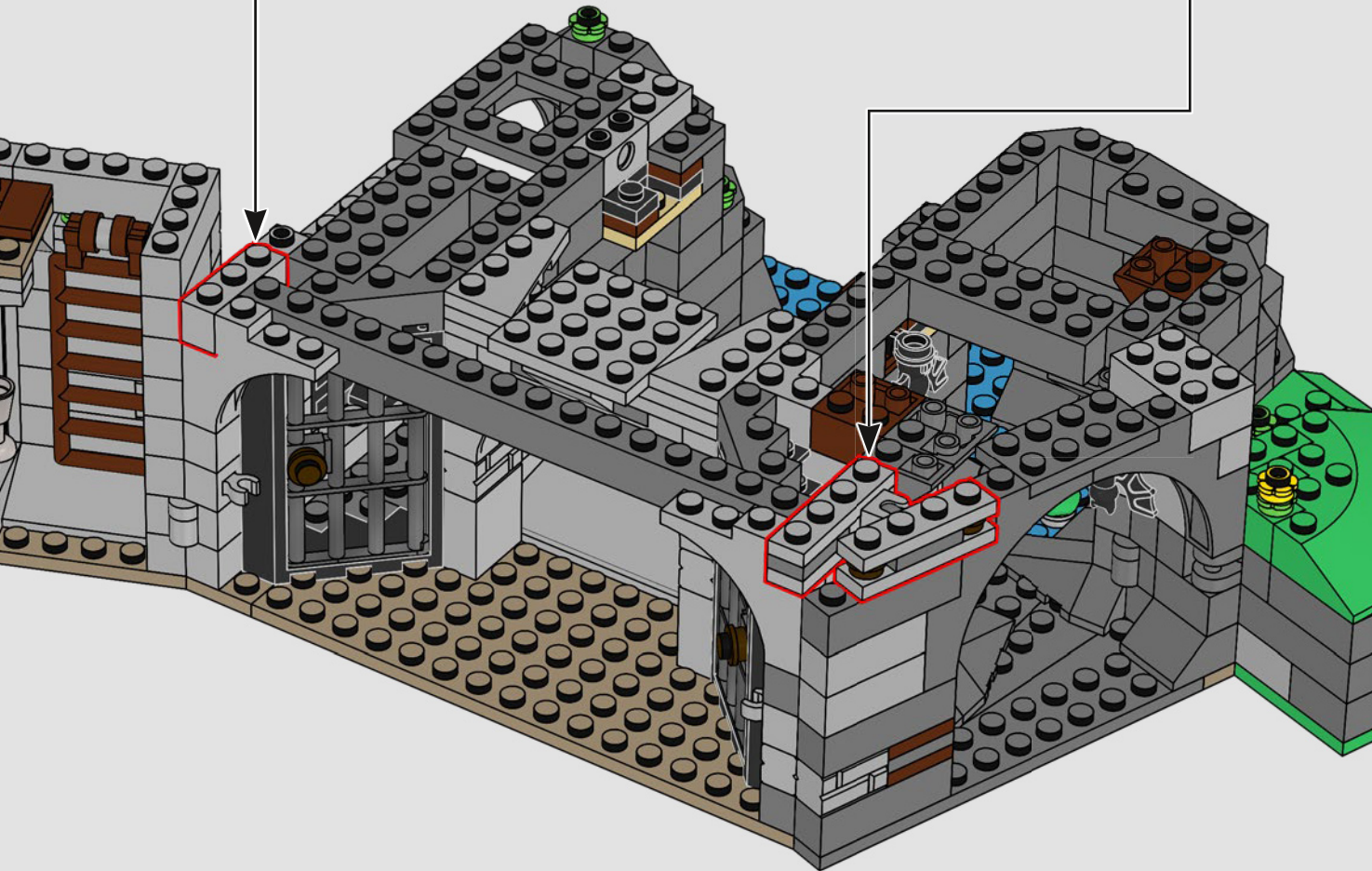
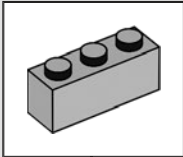
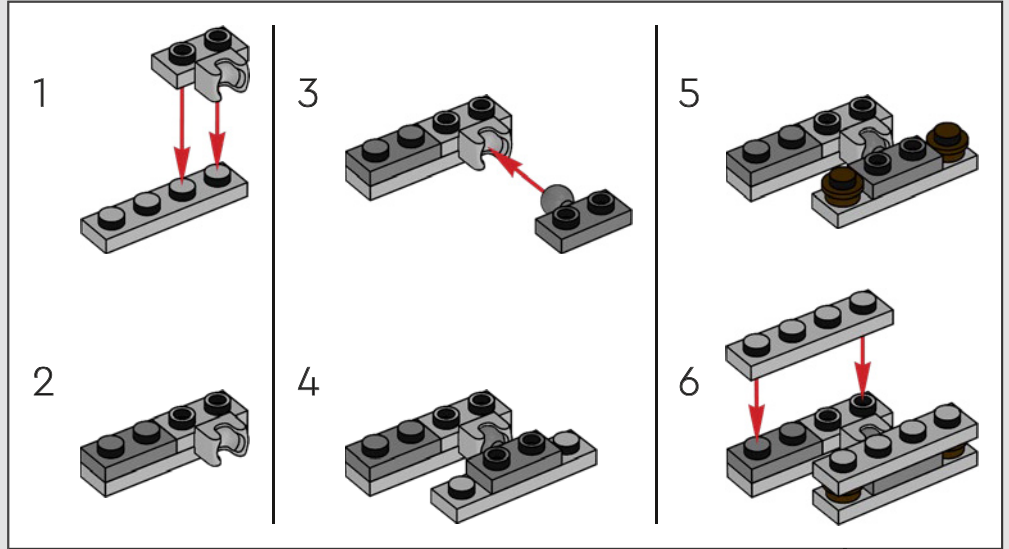

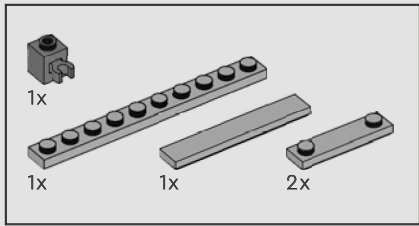

365

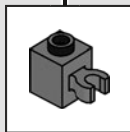
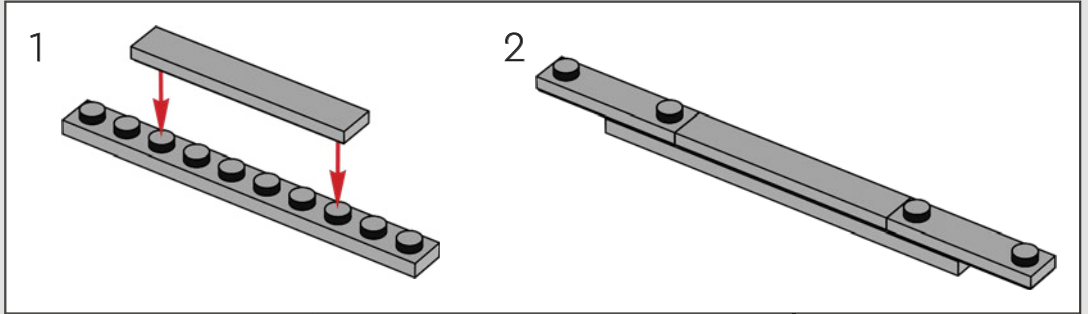



That lad's seen one too many days in our dungeons!

Ce garçon a passé trop de temps dans nos cachots !

¡Ese chico ha pasado demasiados días en nuestros calabozos!

366

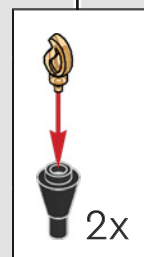
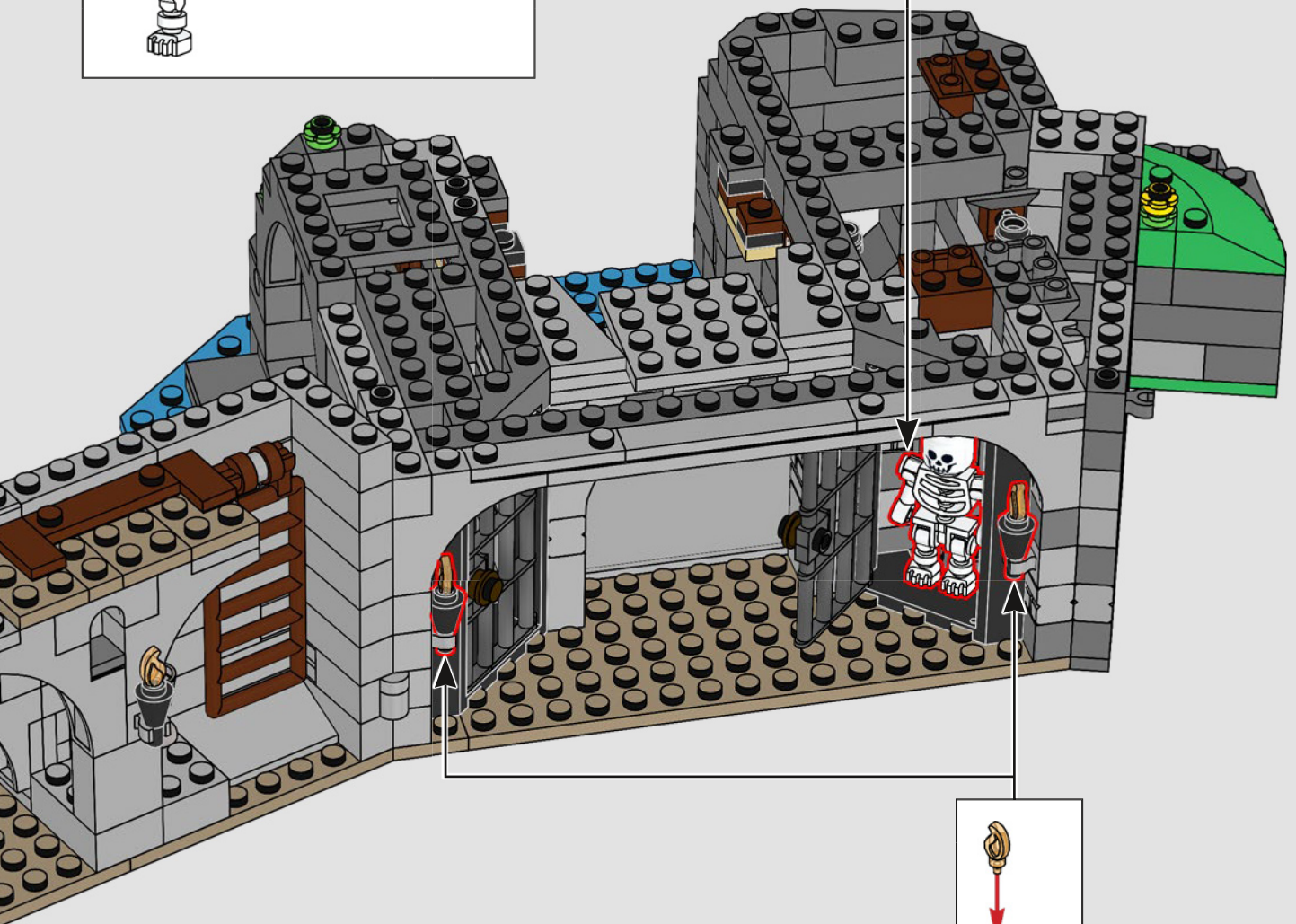
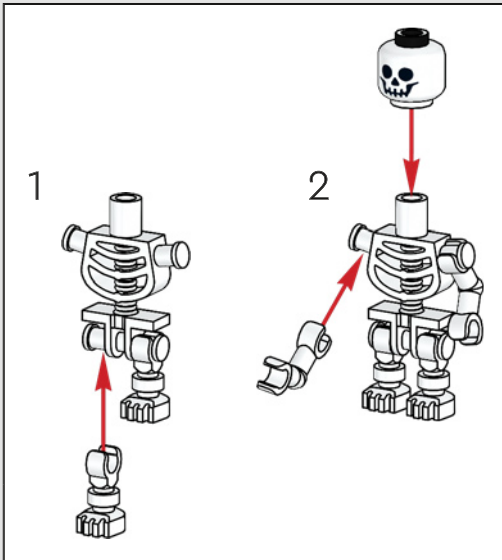

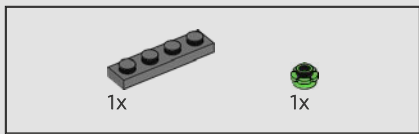

367

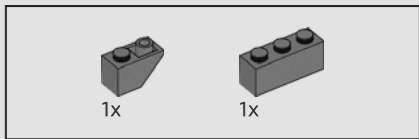
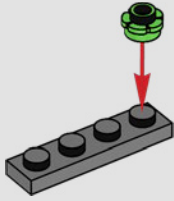

368

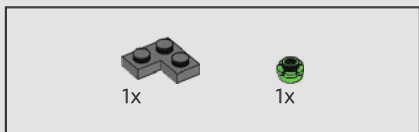
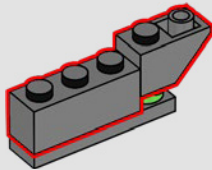

369

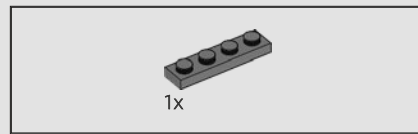
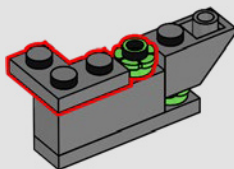

370

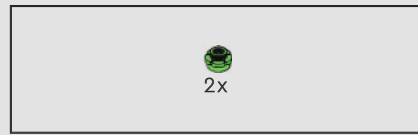
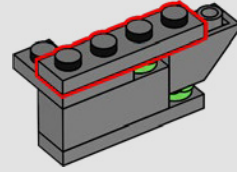

371

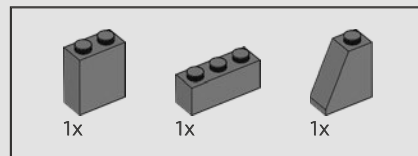
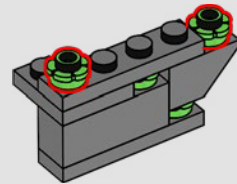

372

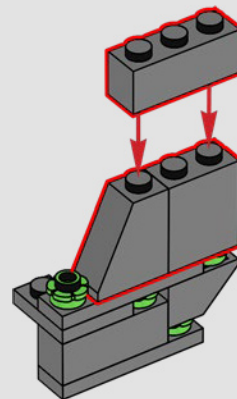

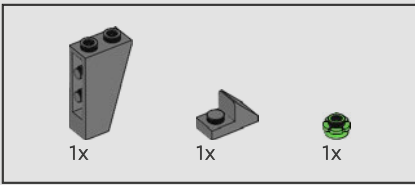

373

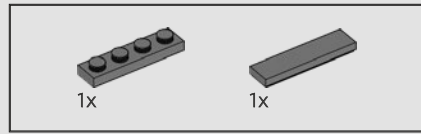
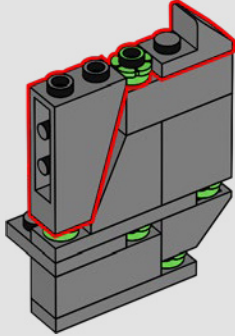

374

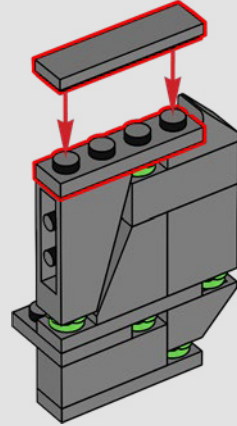

375

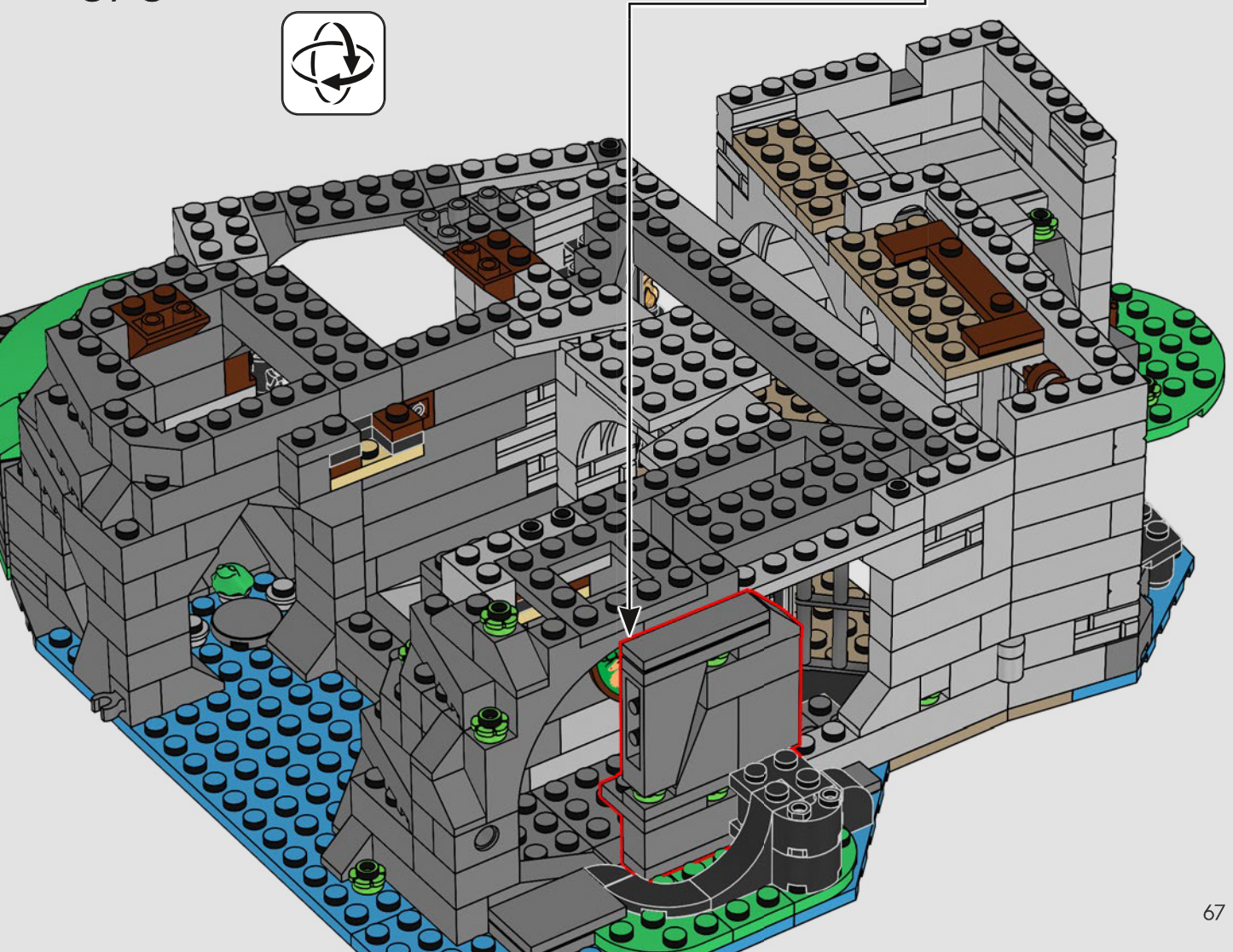

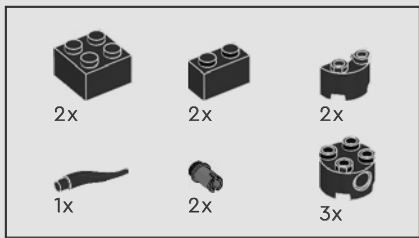

376

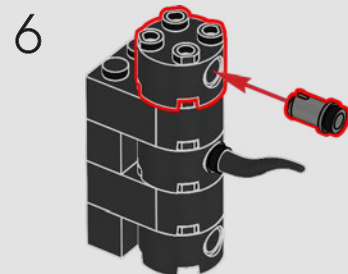
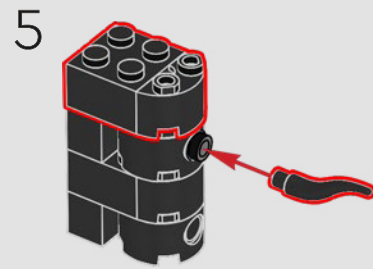
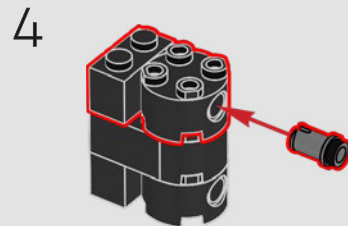
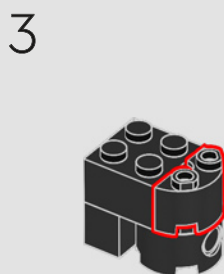
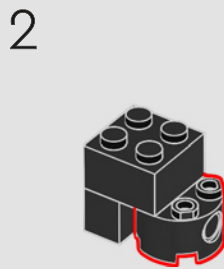
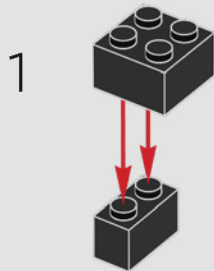

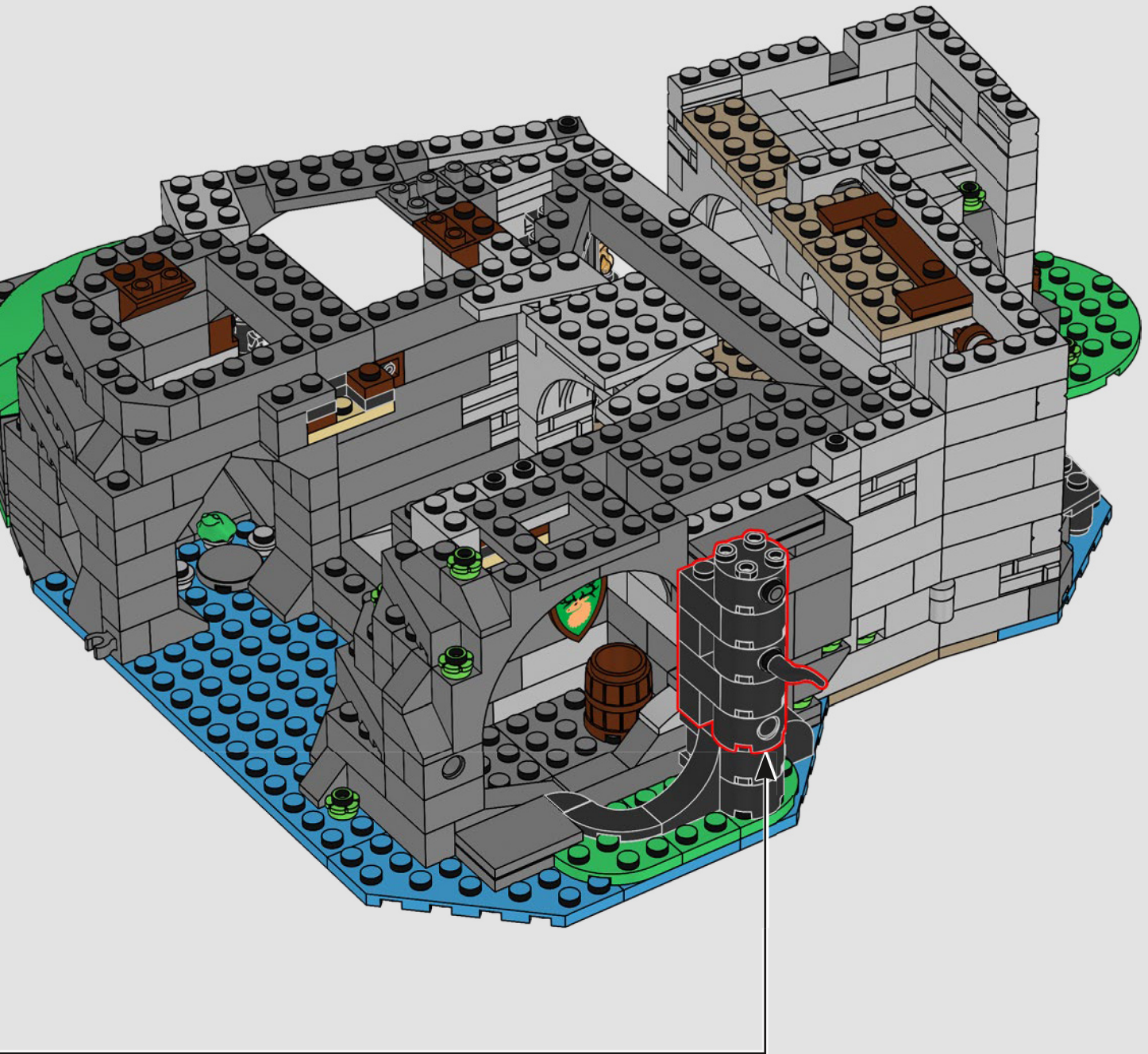

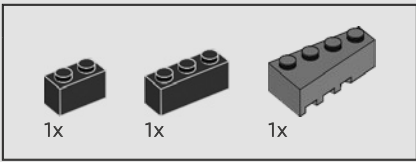

377

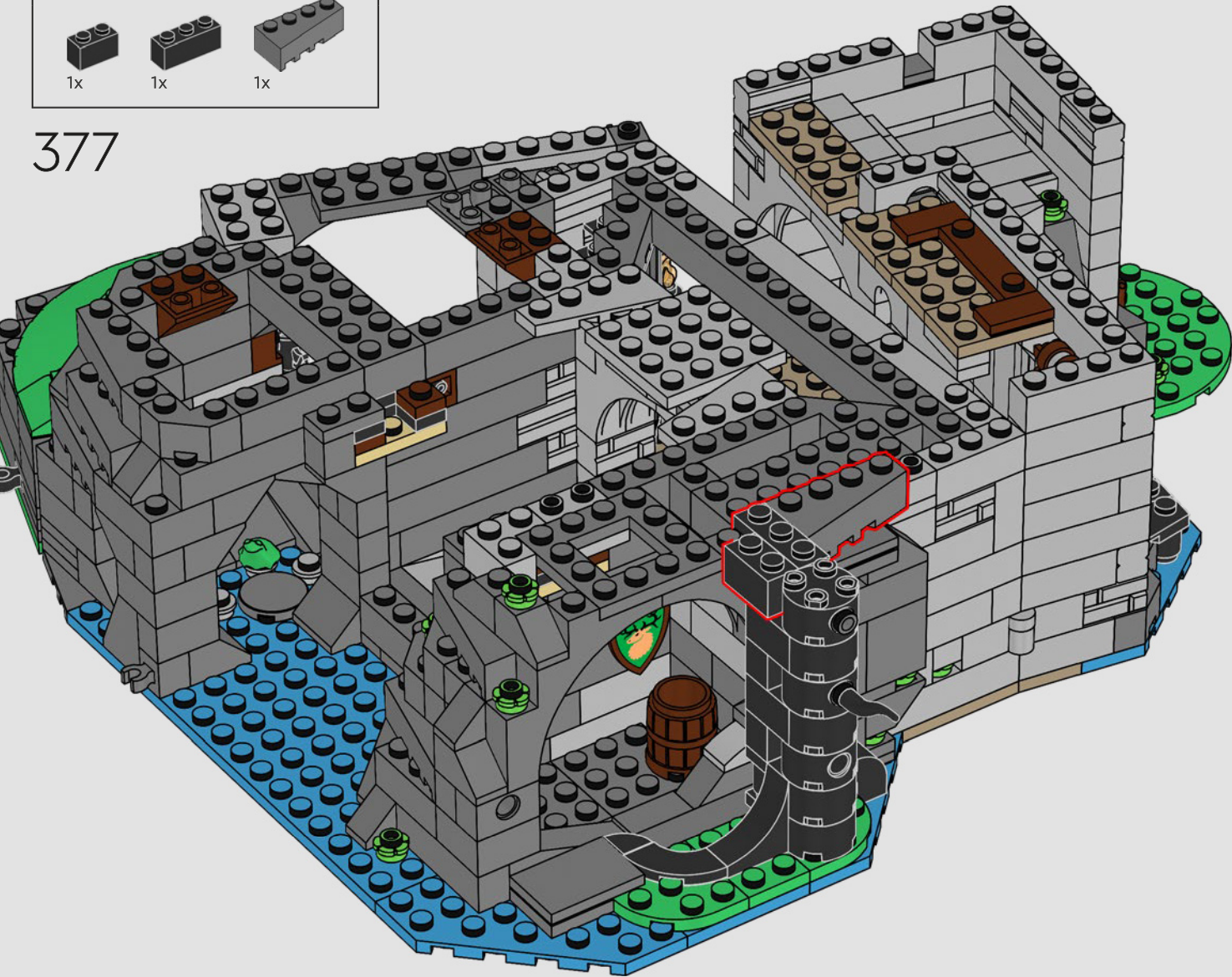

There seems to be a trick in this cell! I shall have to talk to her Ladyship to make sure it's properly sealed!

Il semble y avoir un problème dans cette cellule ! Je vais devoir parler à Madame pour assurer qu'elle est bien verrouillée !

¡Parece que esta celda tiene algún truco! Hablaré con la señora del castillo para asegurarme de que esté bien sellada.

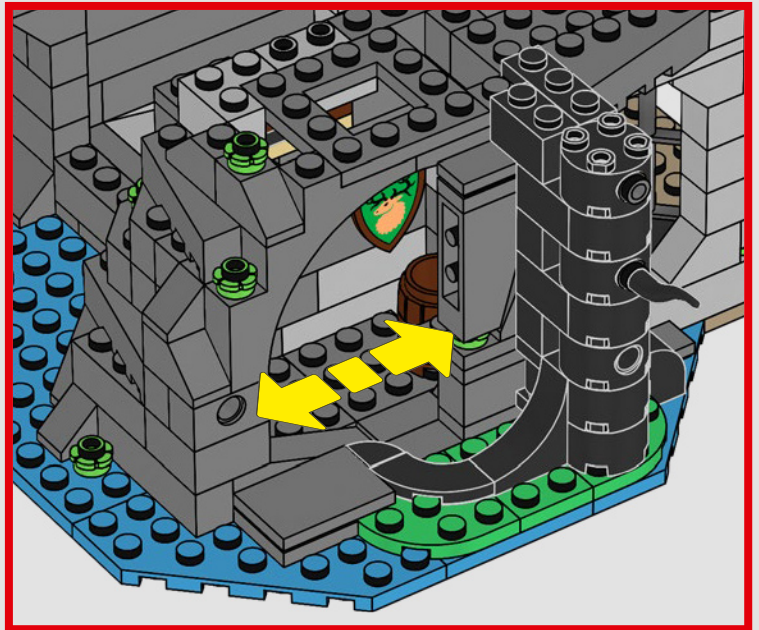

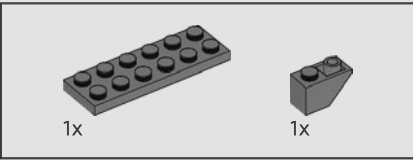
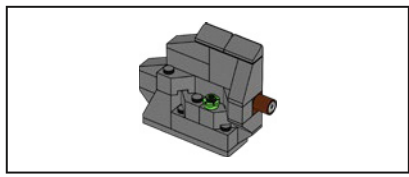

378

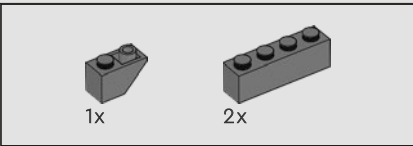
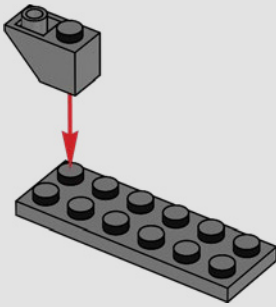

379

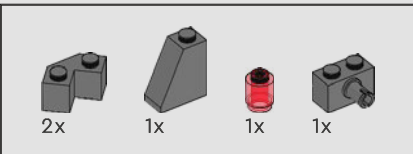
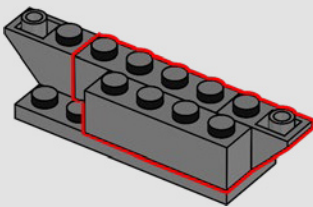

380

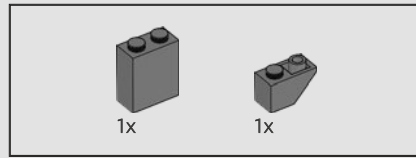
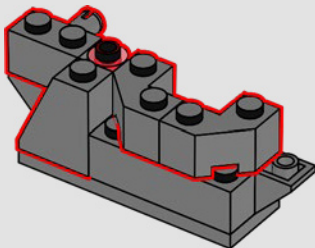

381

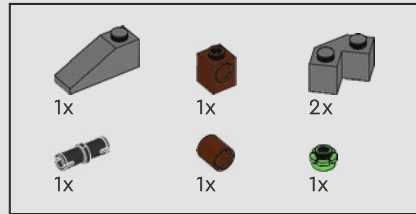
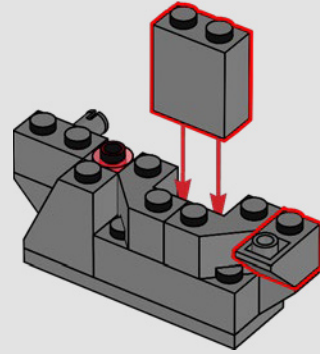

382

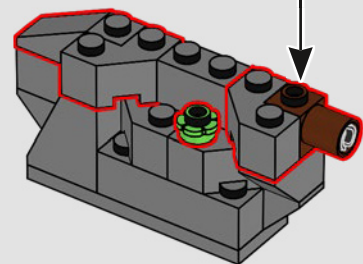
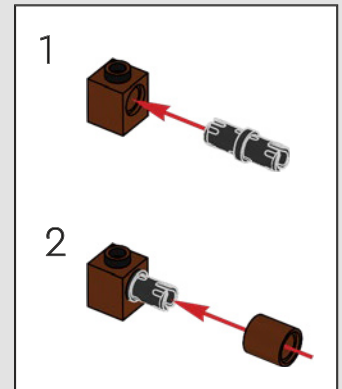

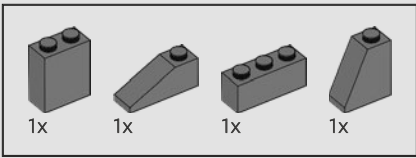

383

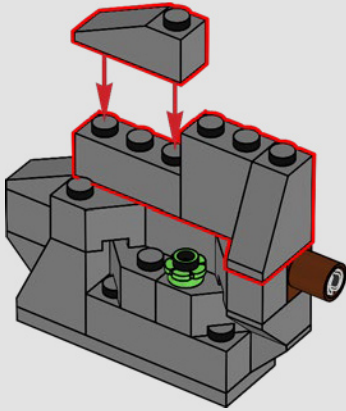

384

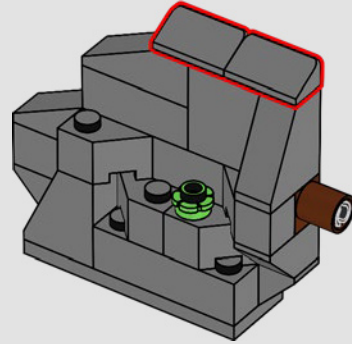

385

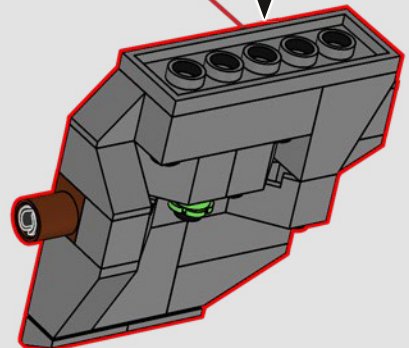
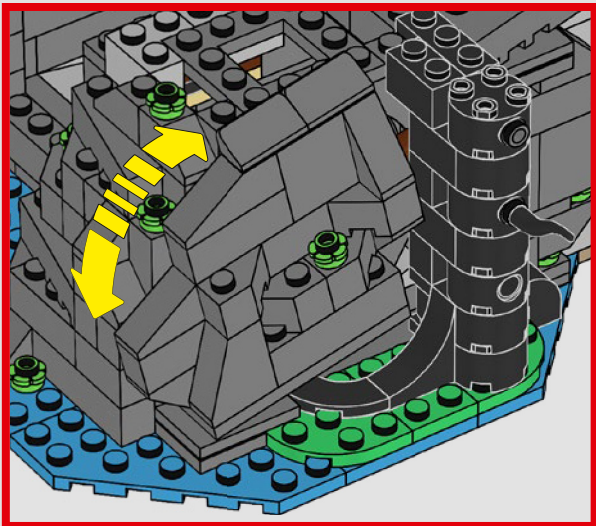
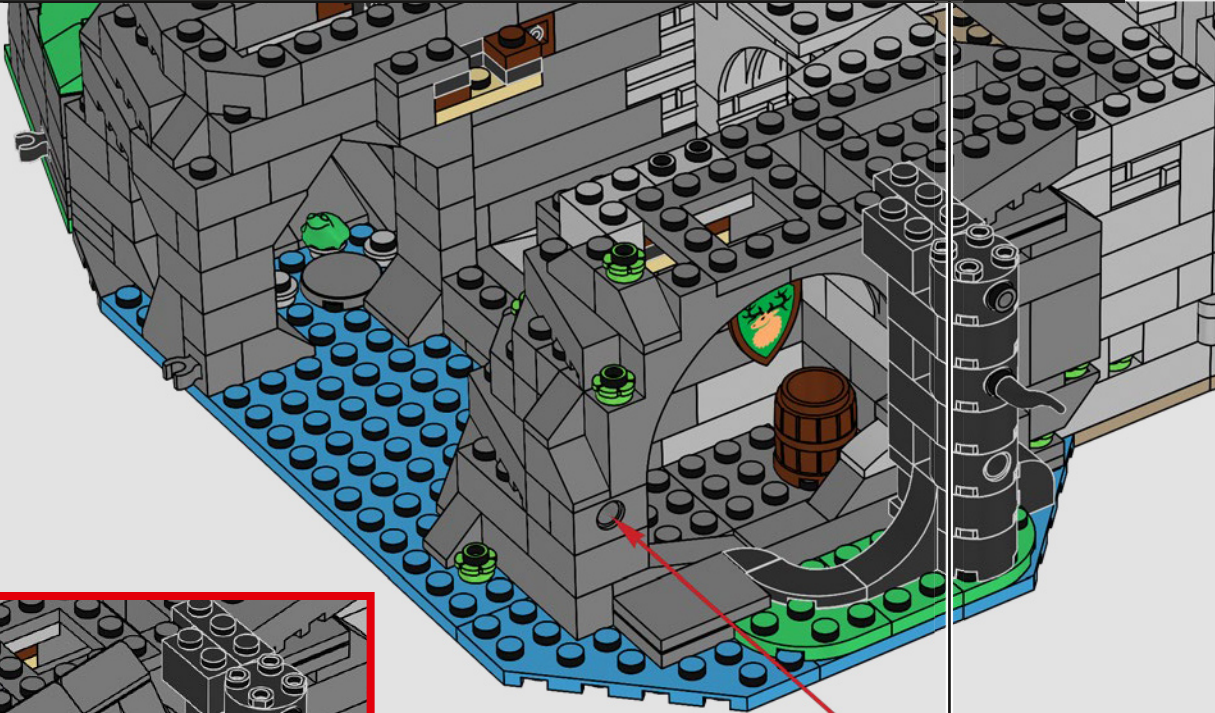

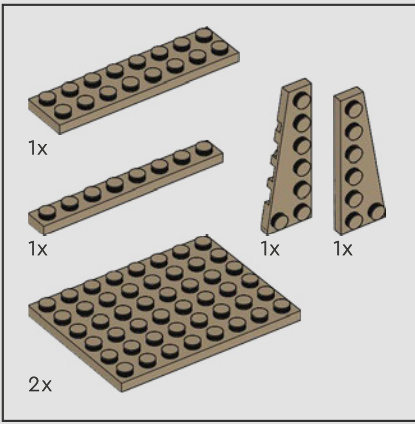

386

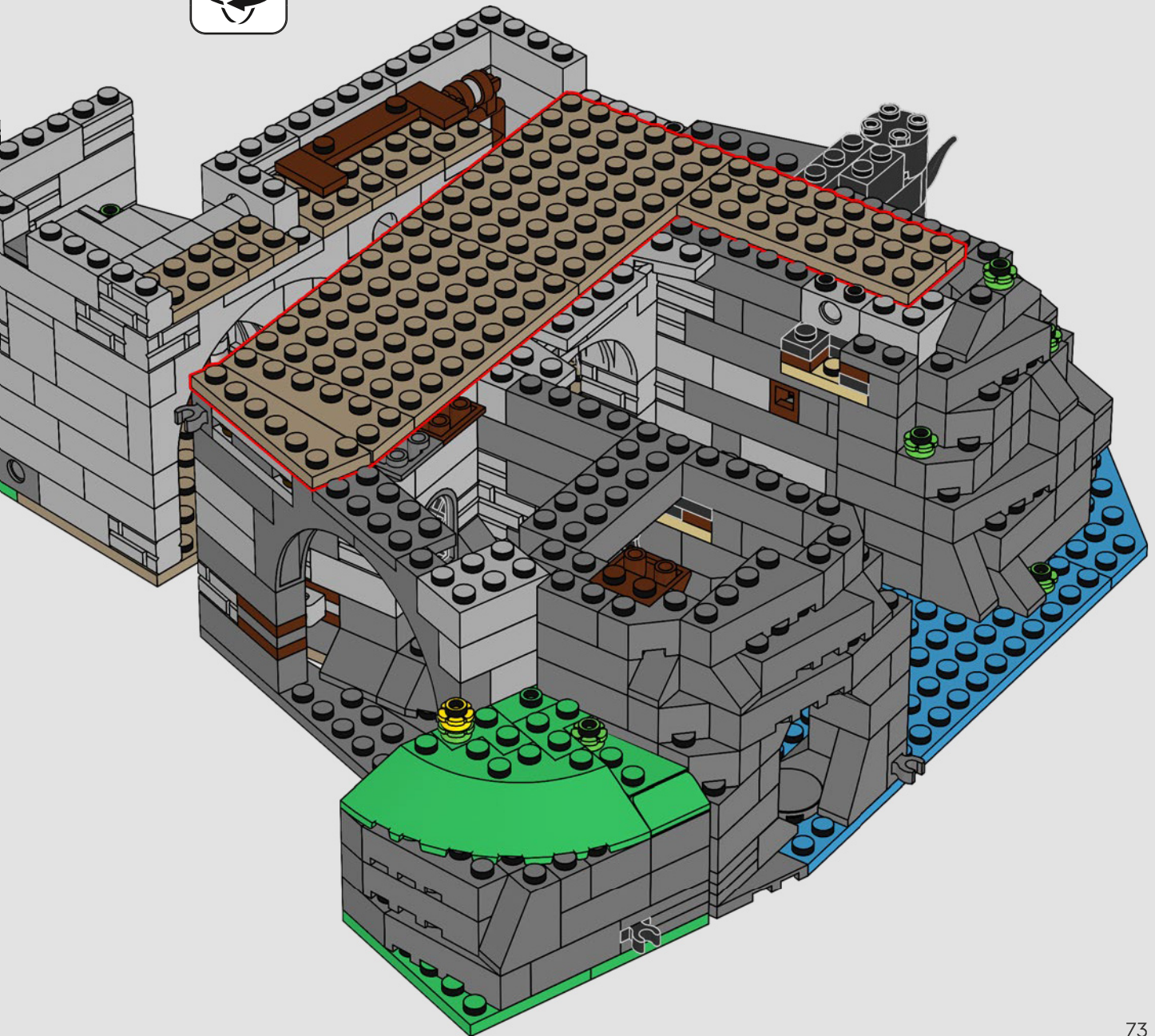

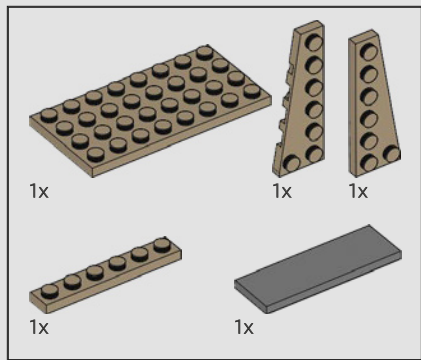

387

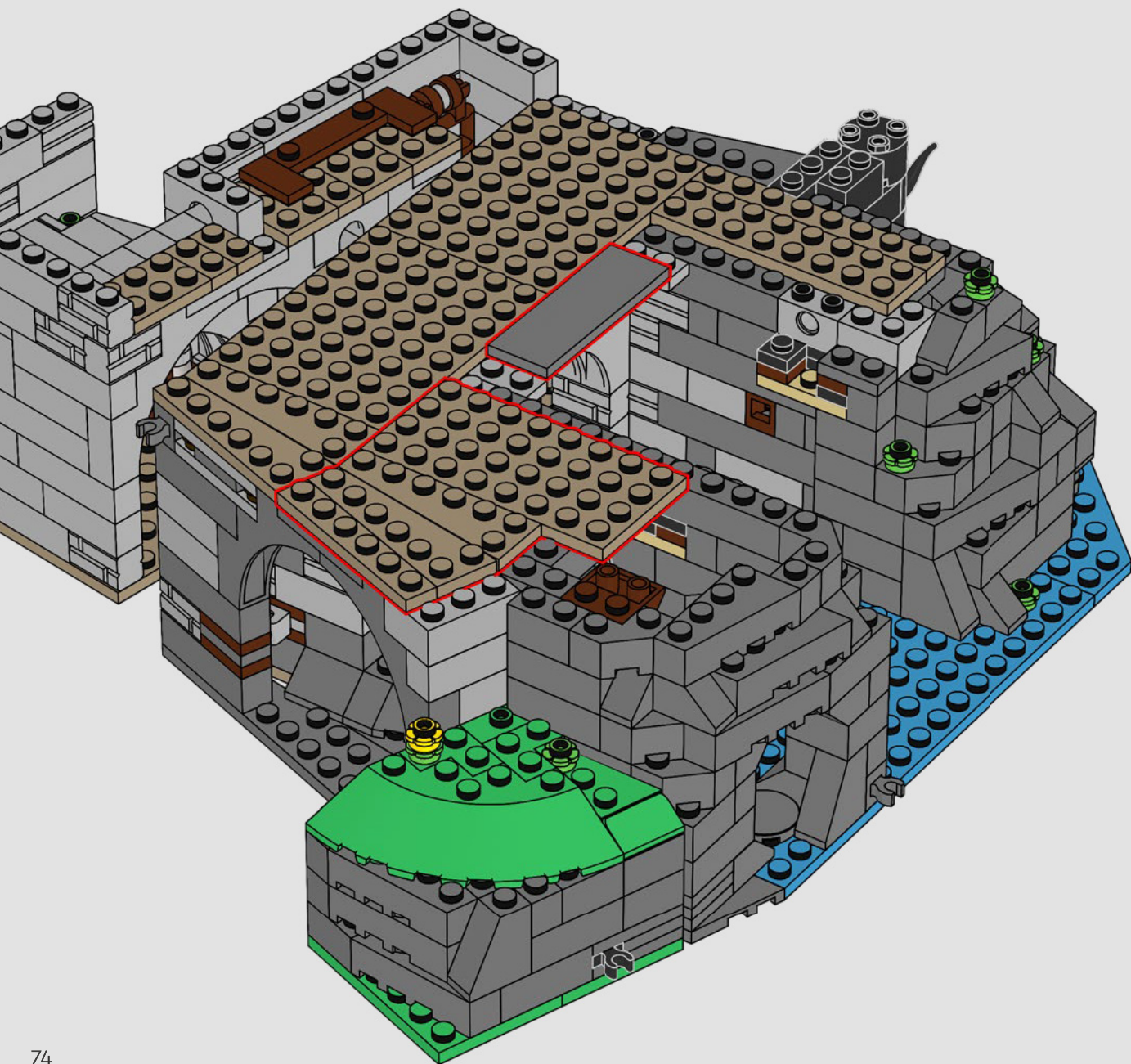

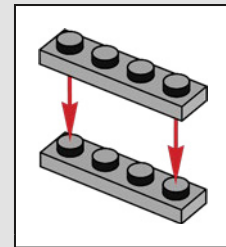
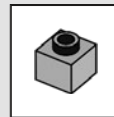
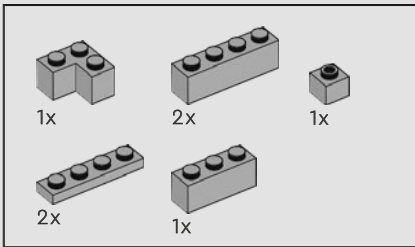

388

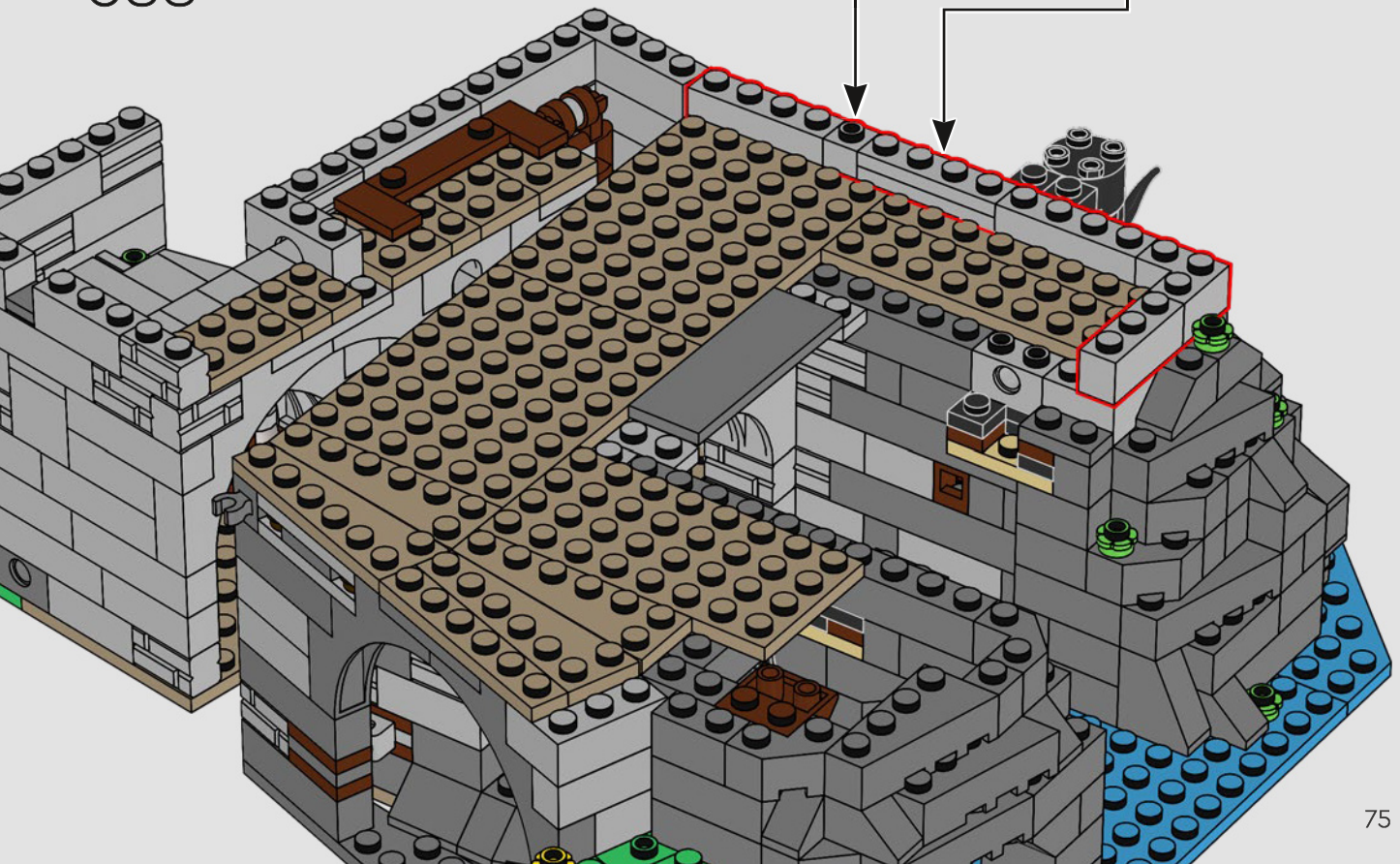

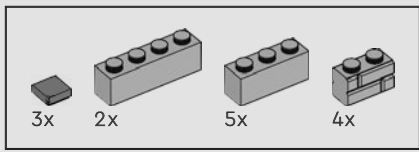

389

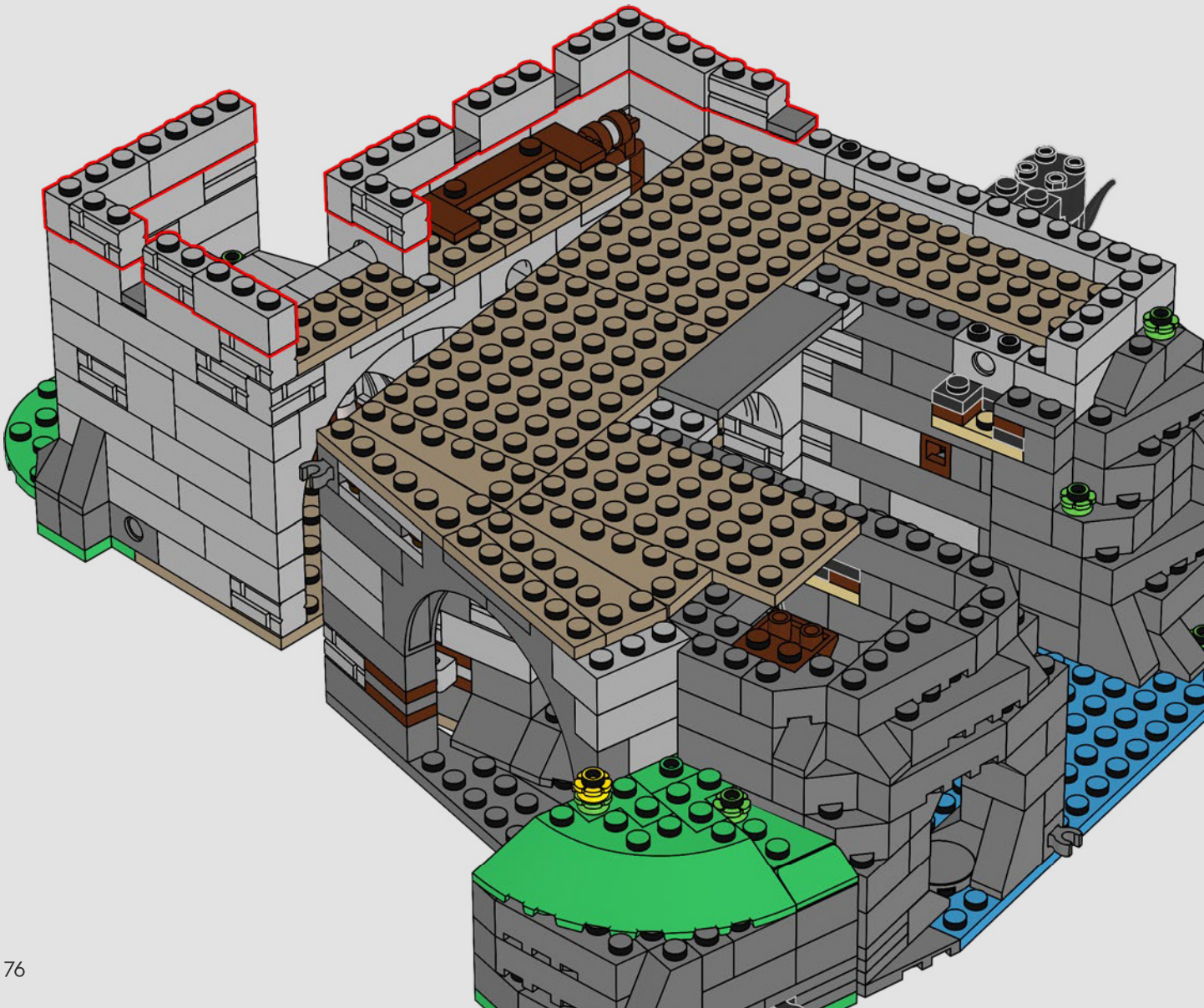



A GEAR!? What sorcery is this??

UN ENGRENAGE ? ! Quelle est cette sorcellerie ? !

¿UN MECANISMO? ¿Qué clase de hechizo es este?

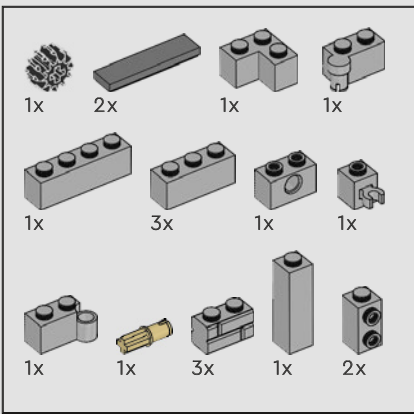

390

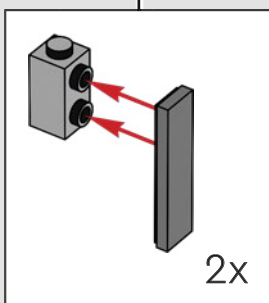
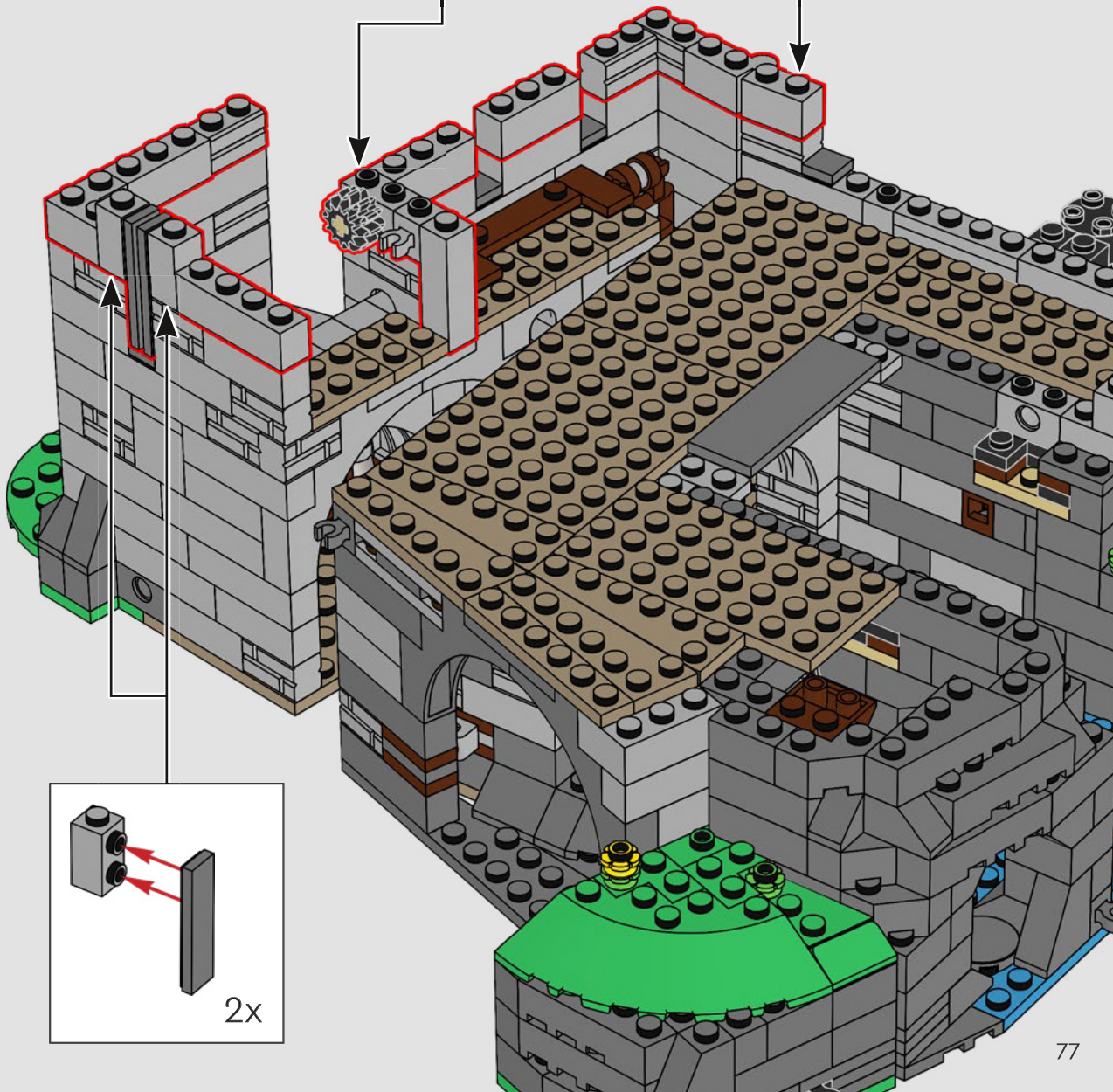
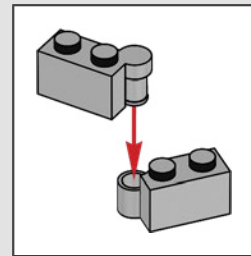
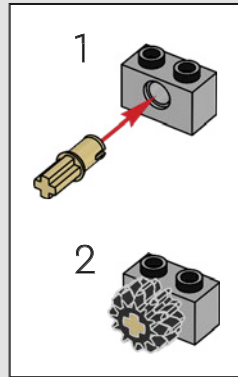

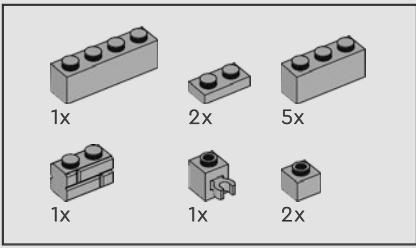

391

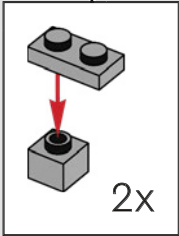
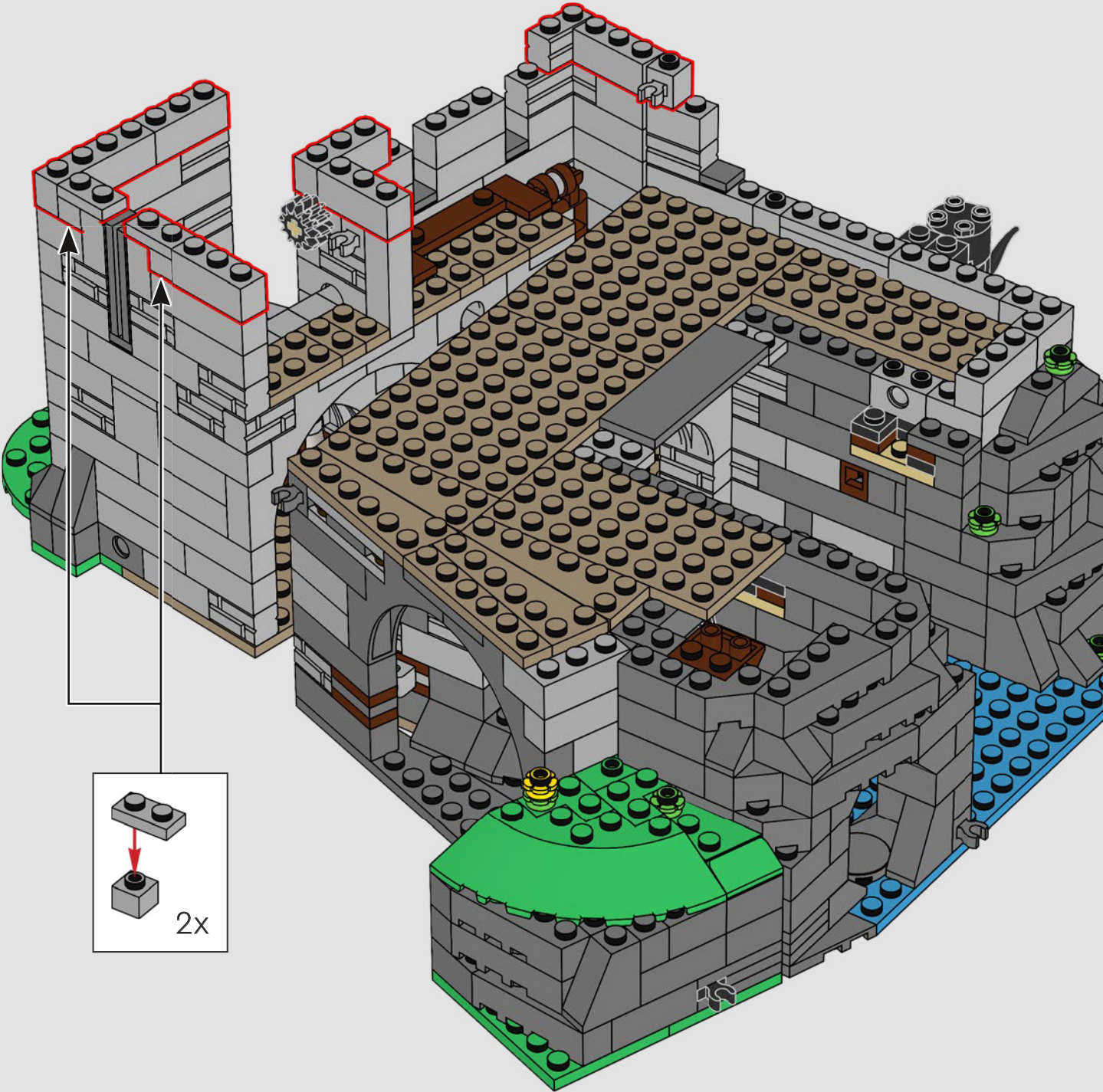

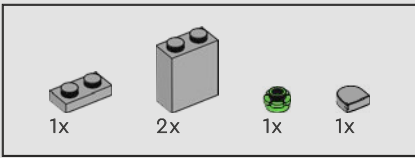

392

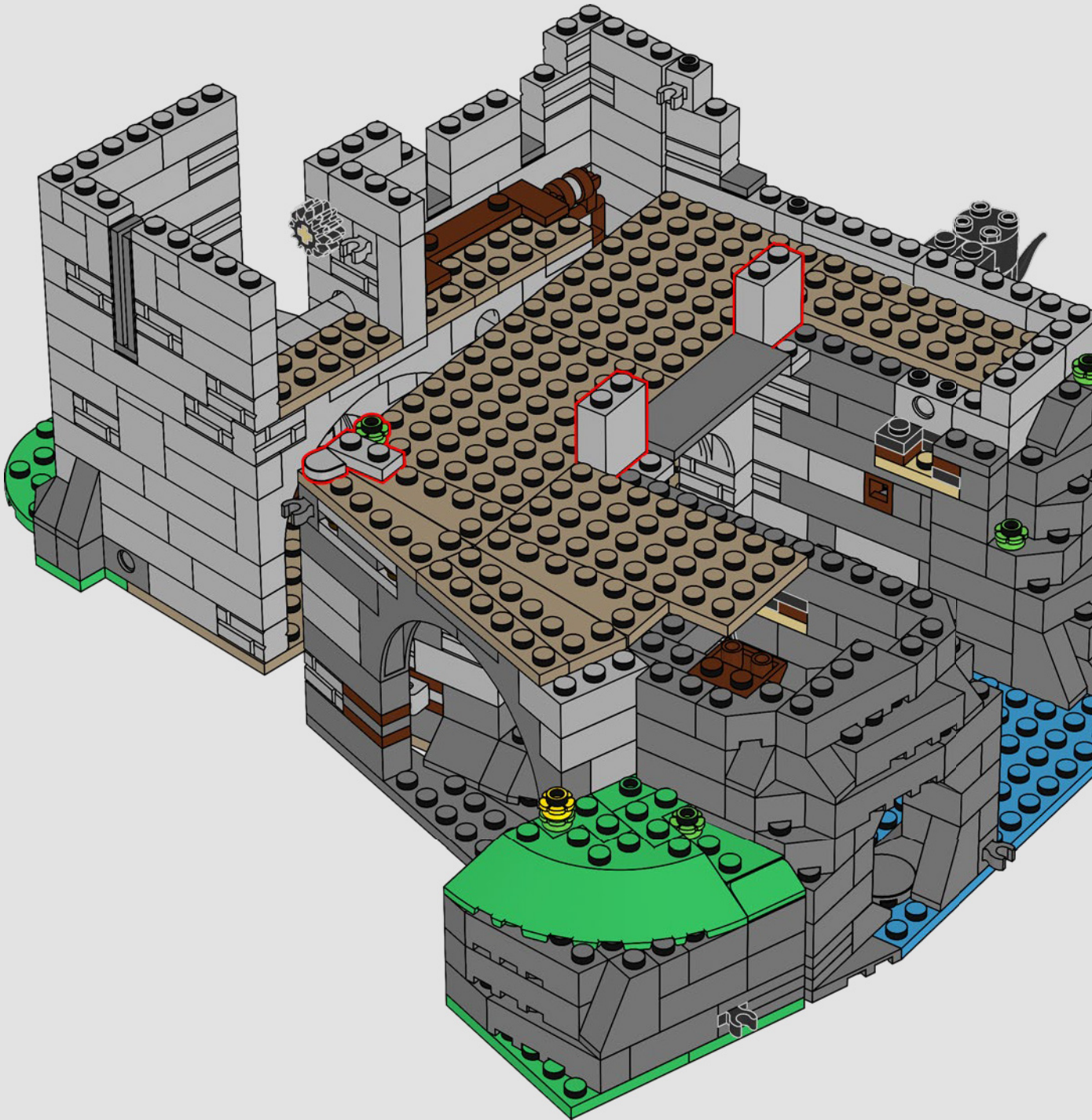

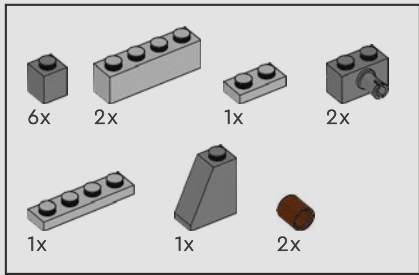

393

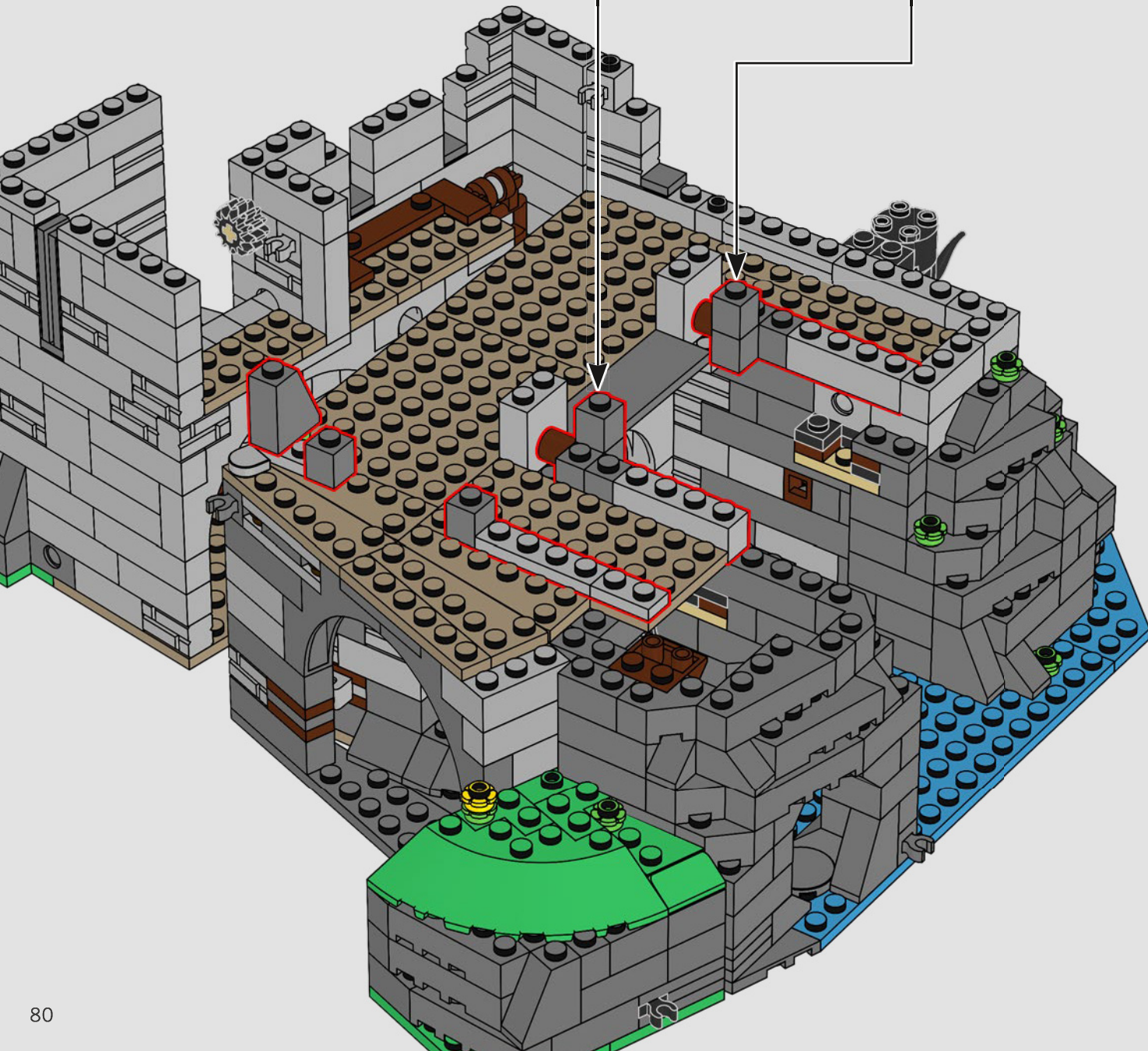
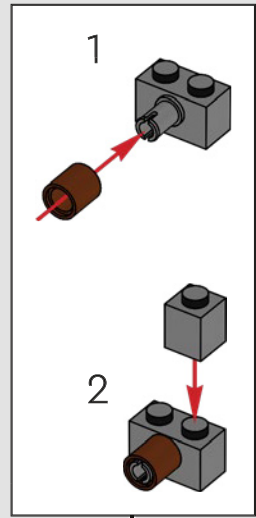
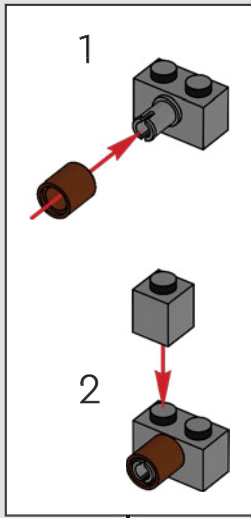

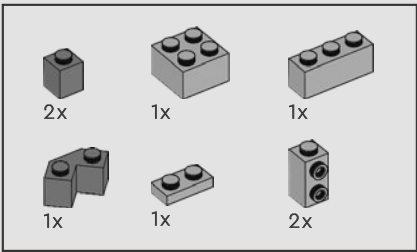

394

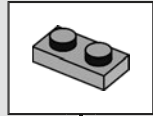

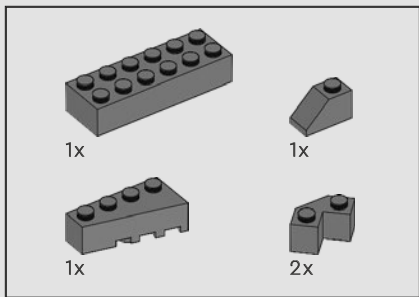

395

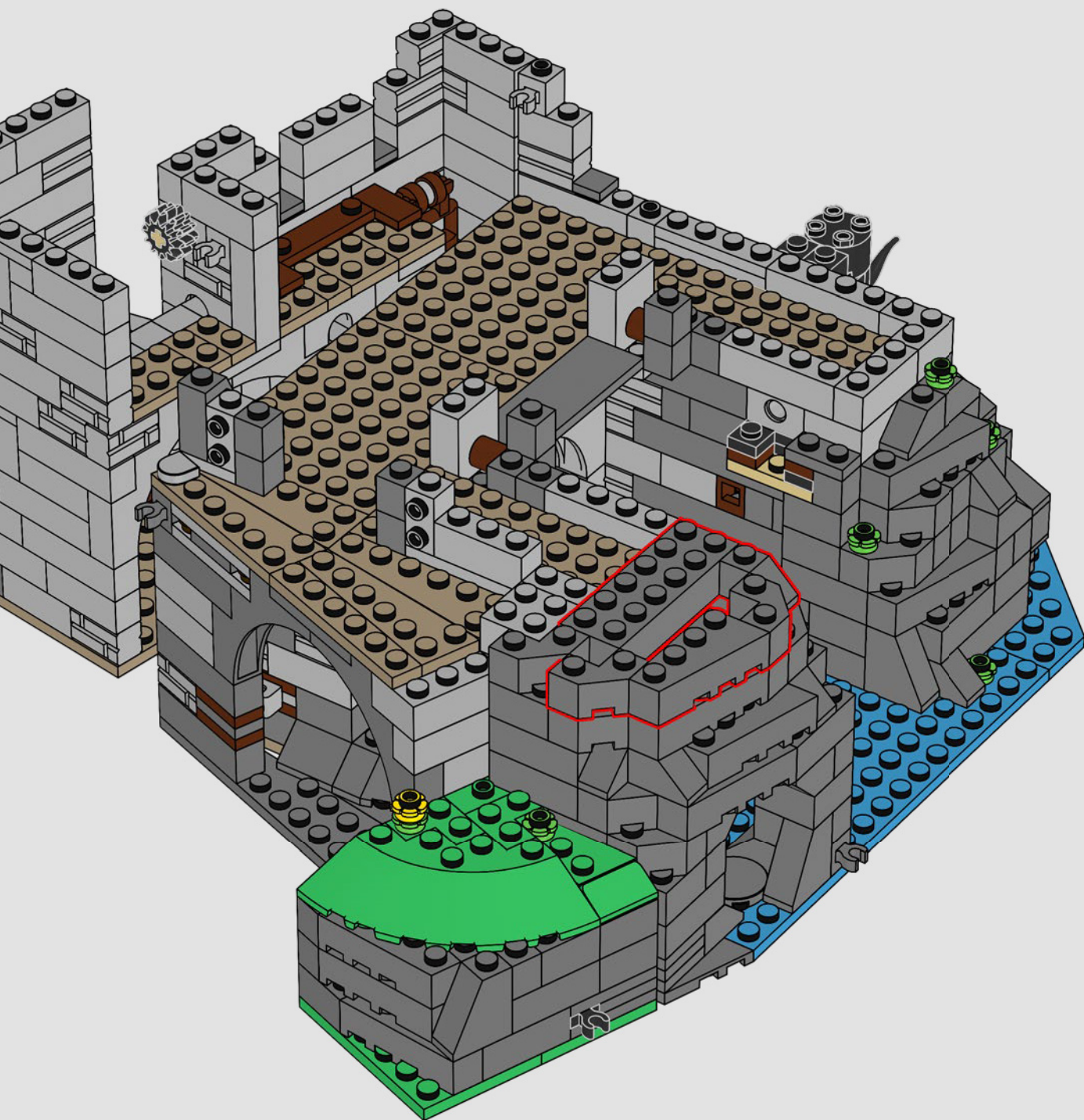

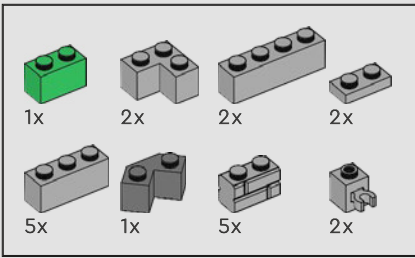

396

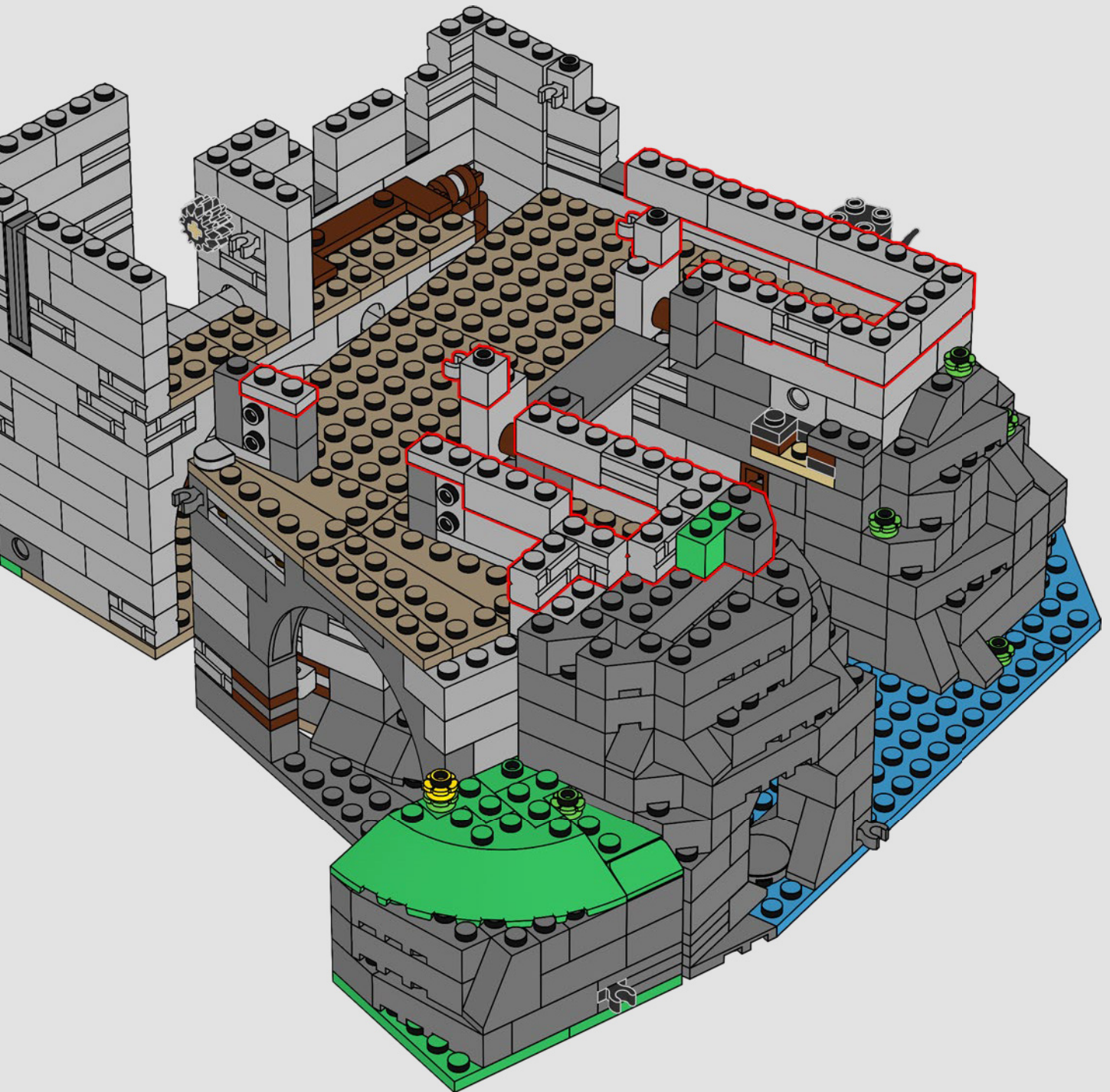

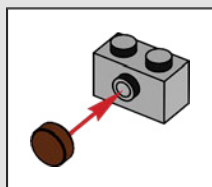
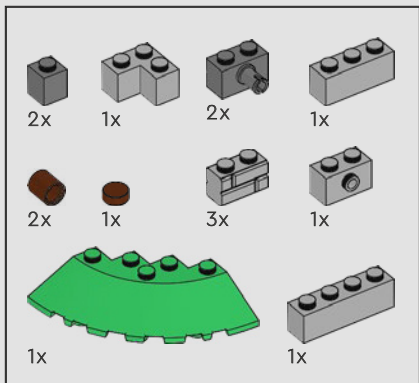

397

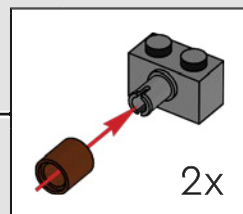
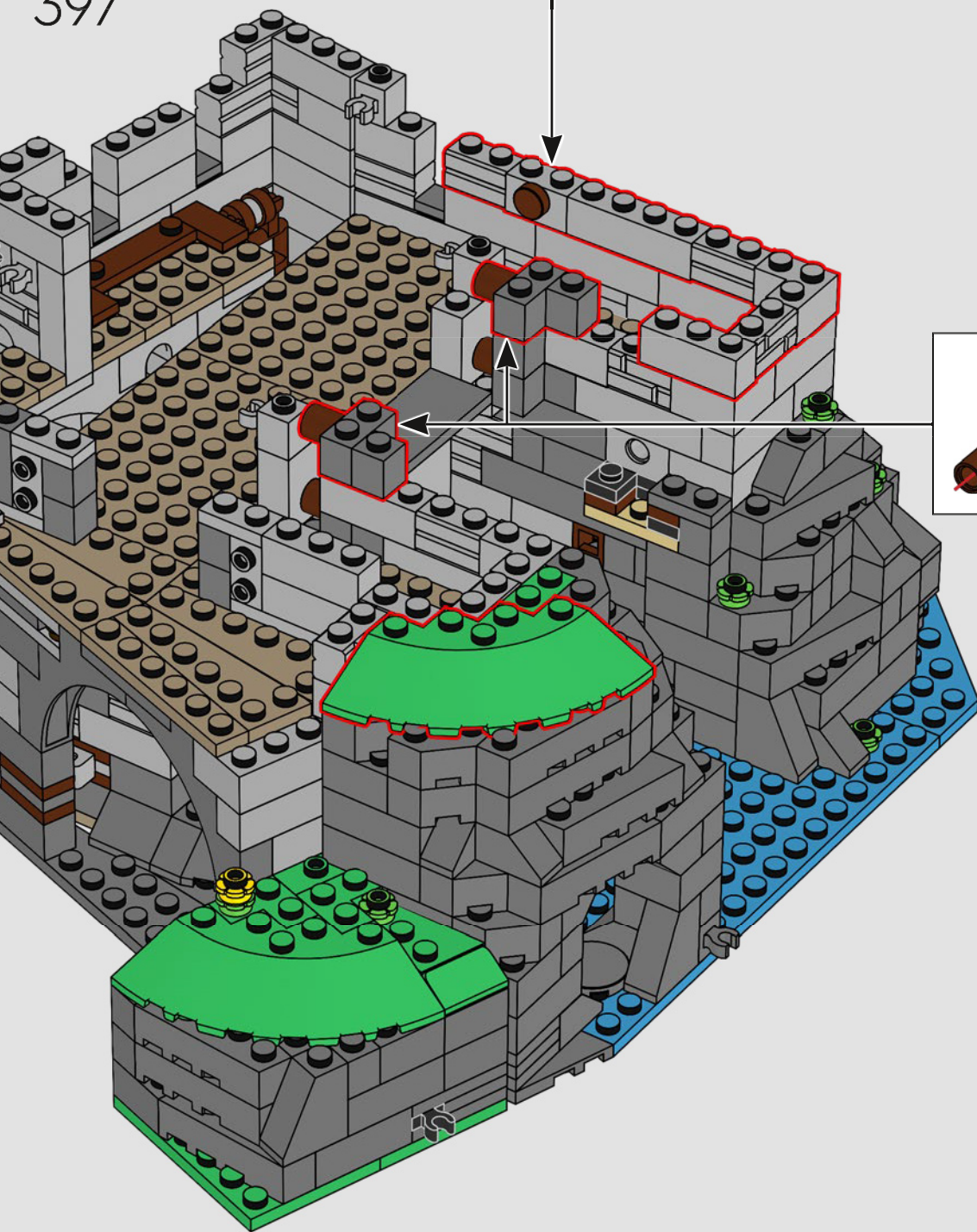



399



400

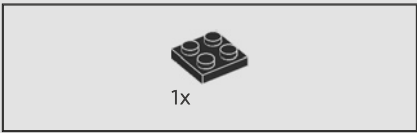
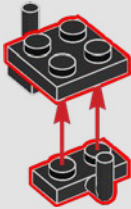

401

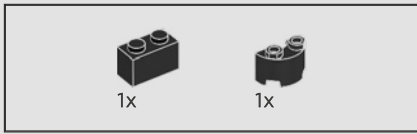
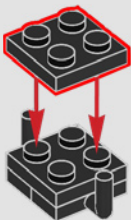

402

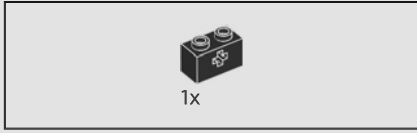
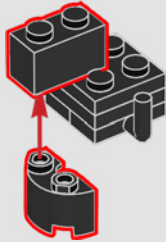

403

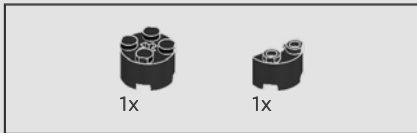
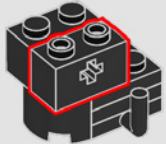

404

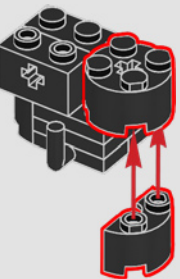

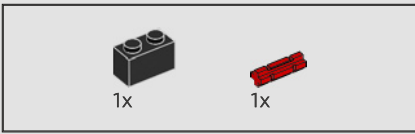

405

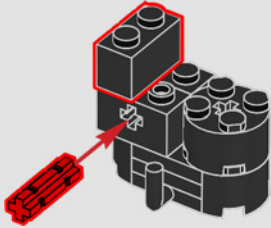

407

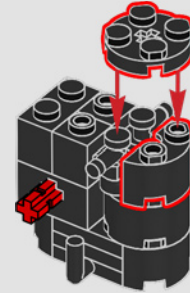

406

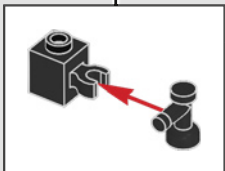
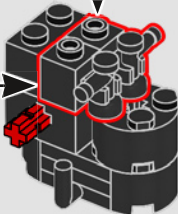
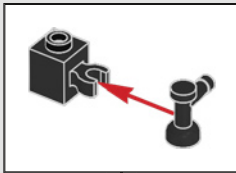

408

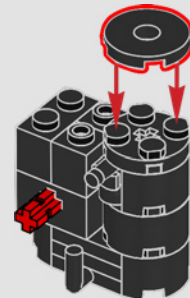

409

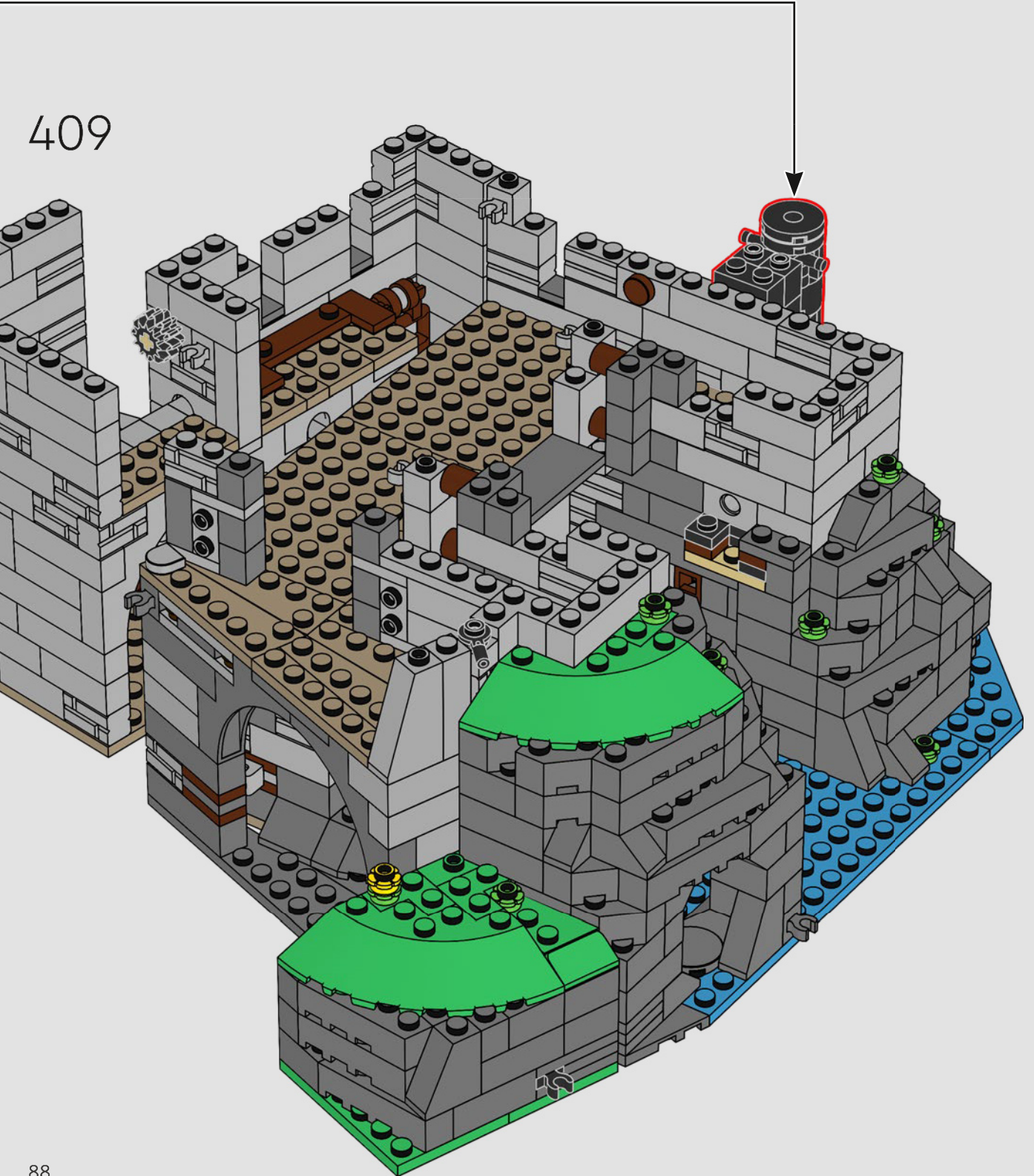

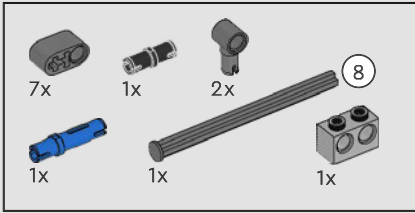
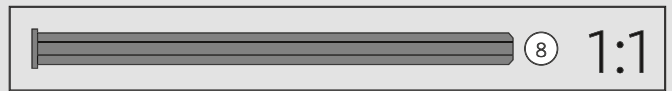
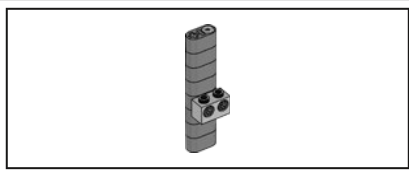

410

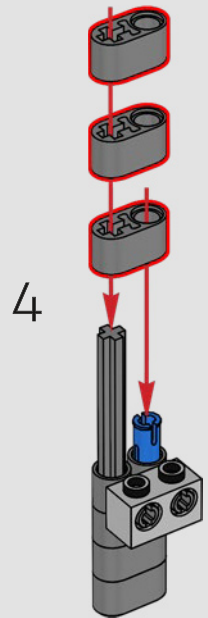
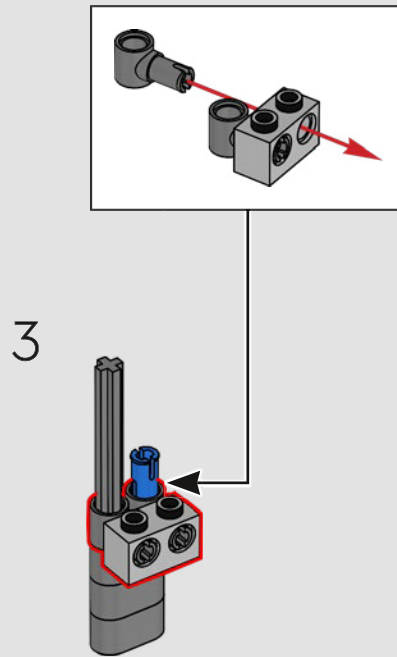
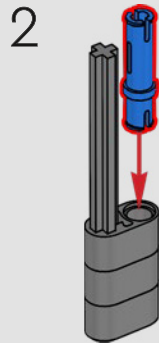
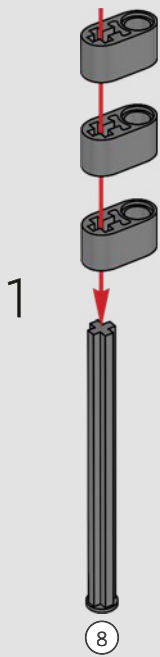

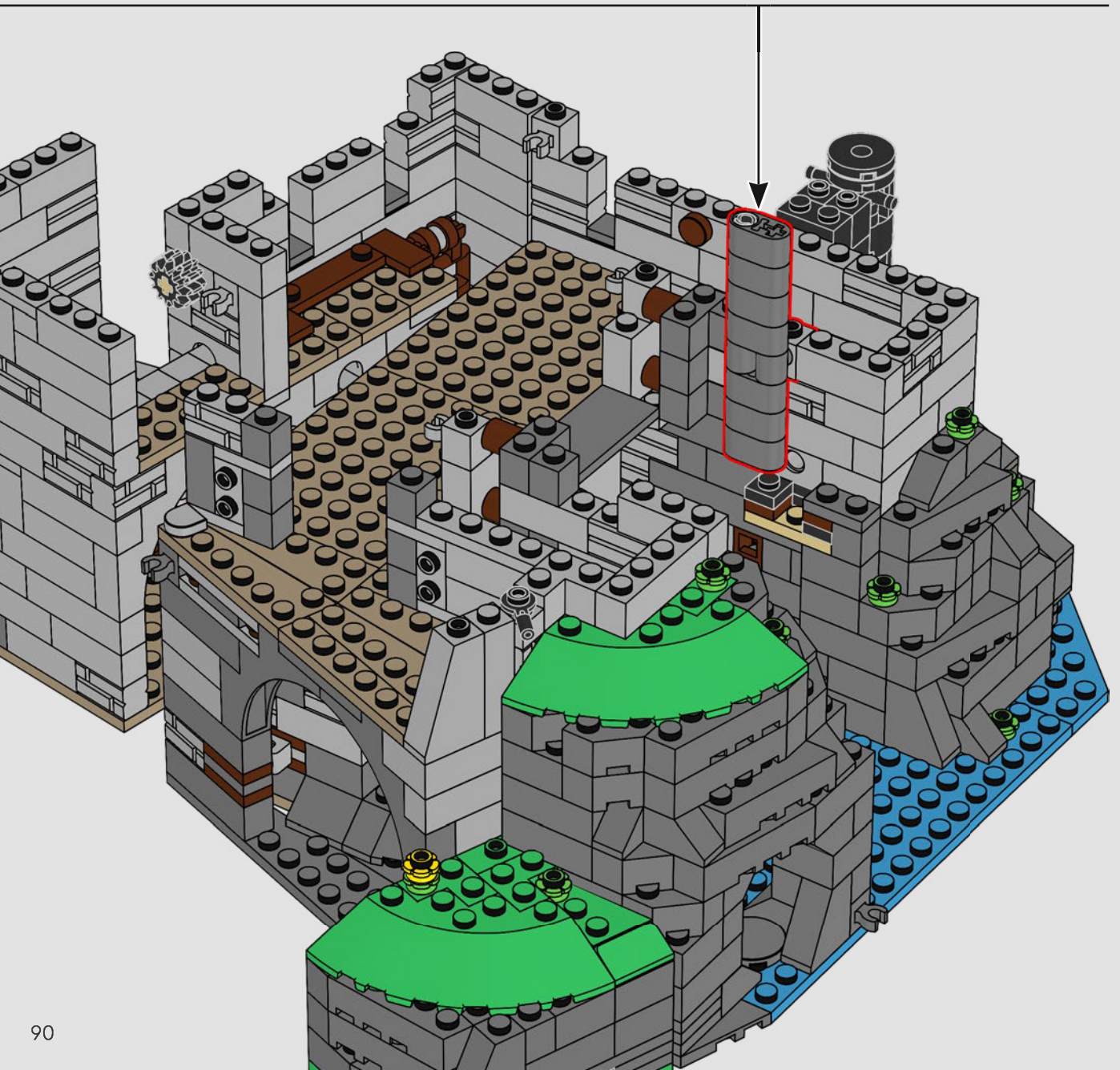
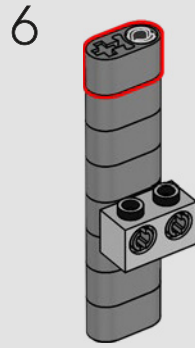
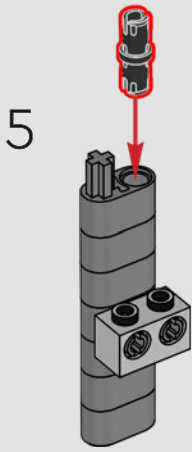

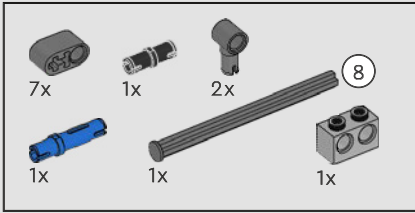
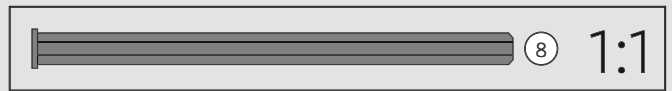
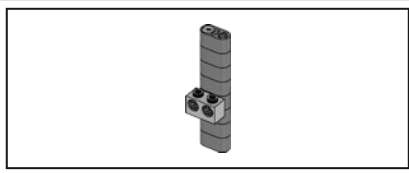

411

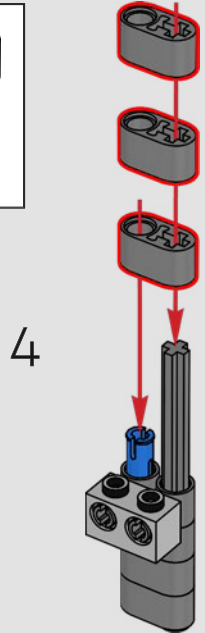
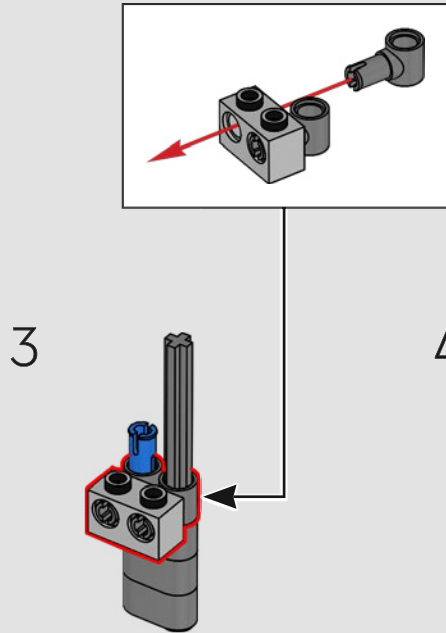
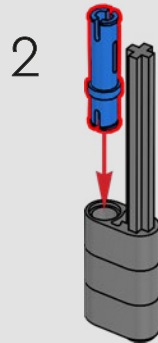
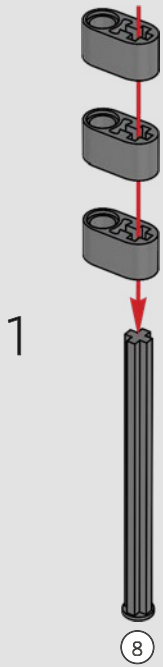

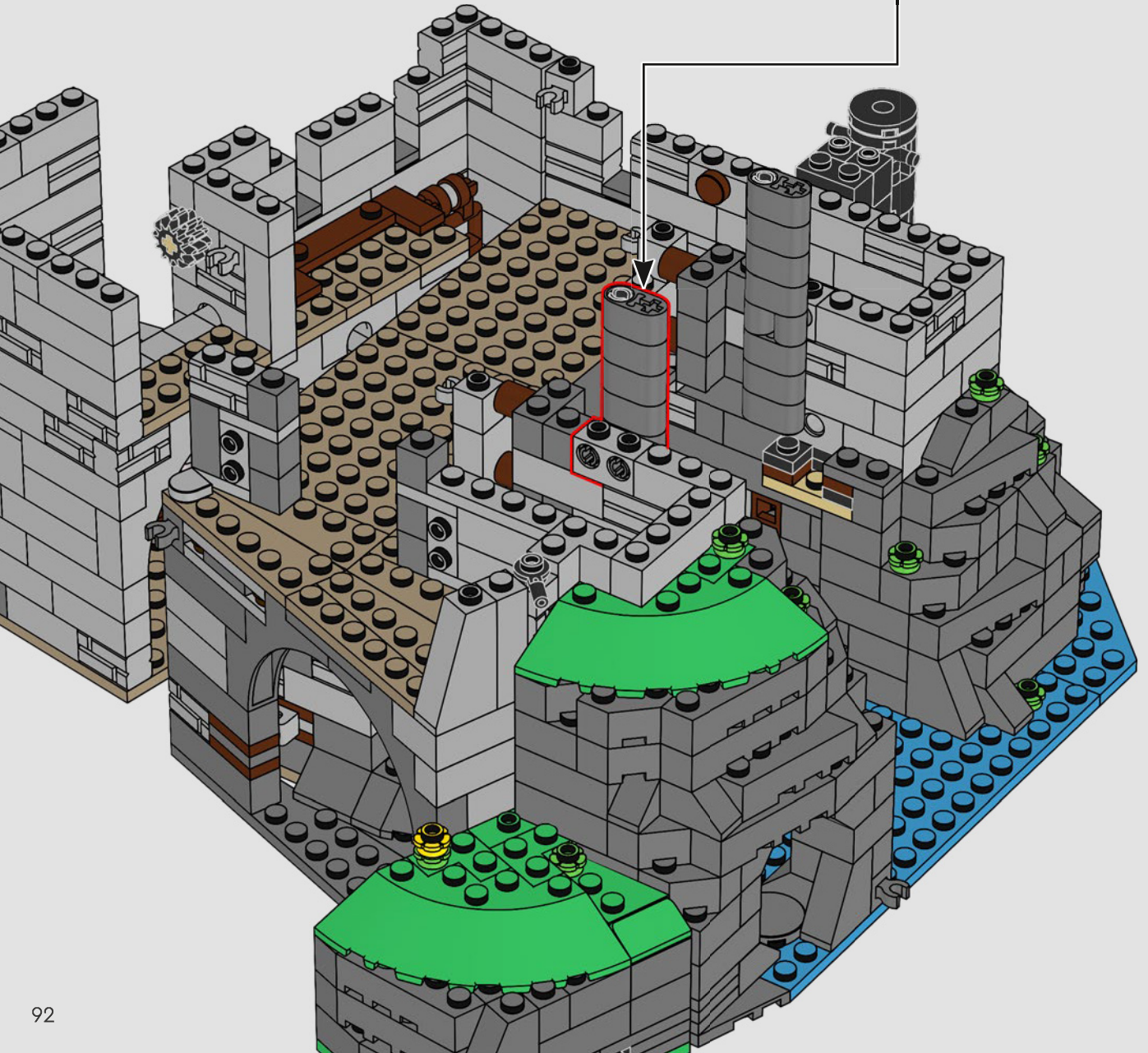
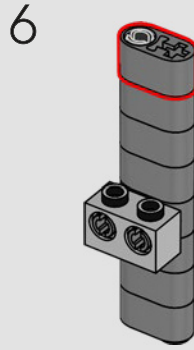
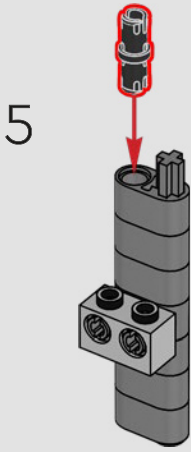

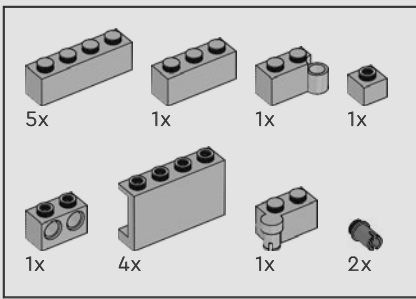

412

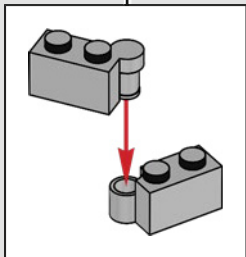
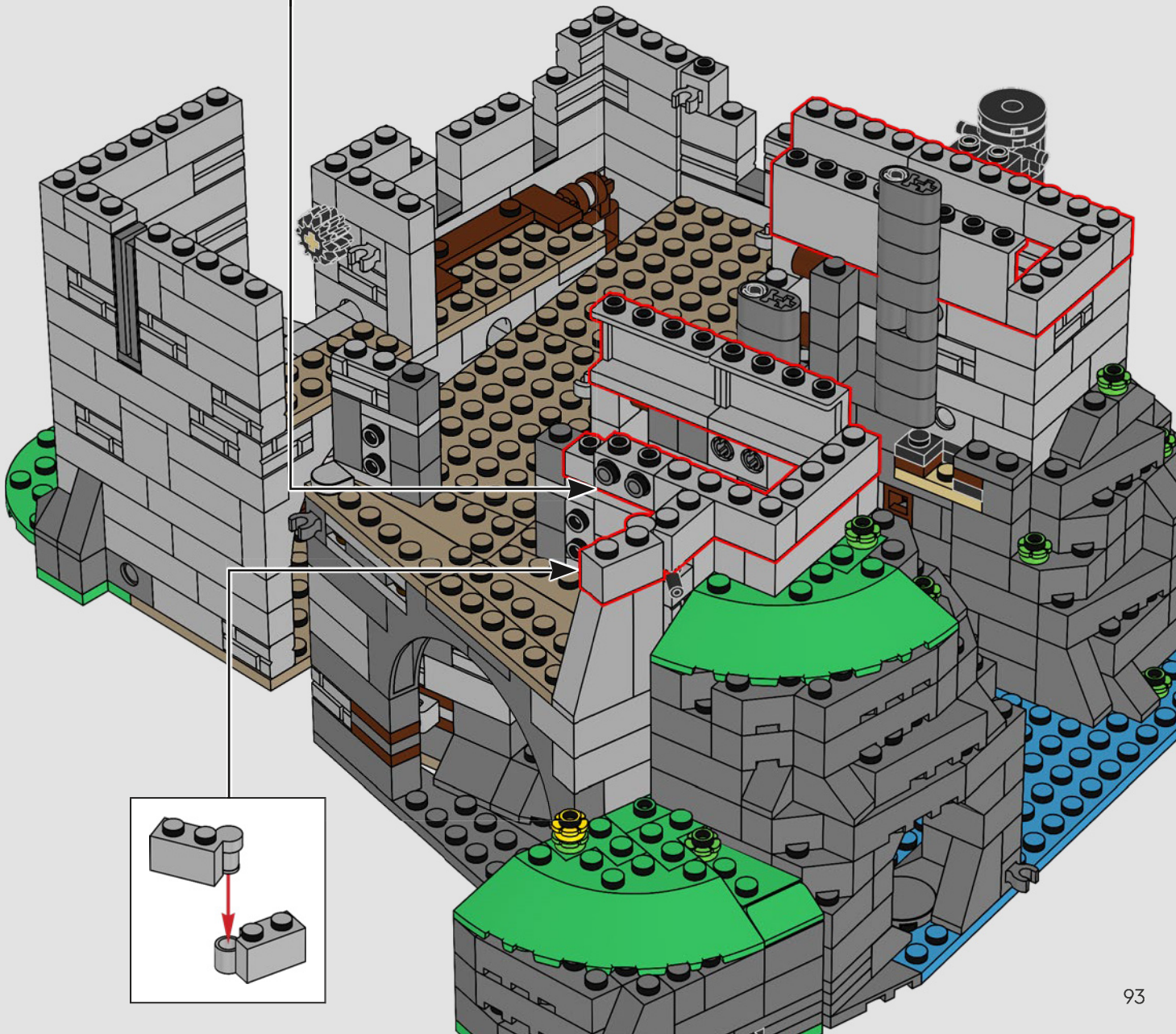
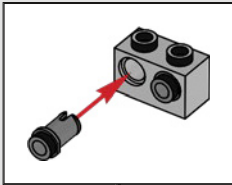

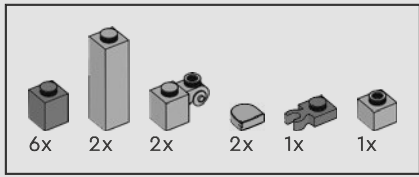

413

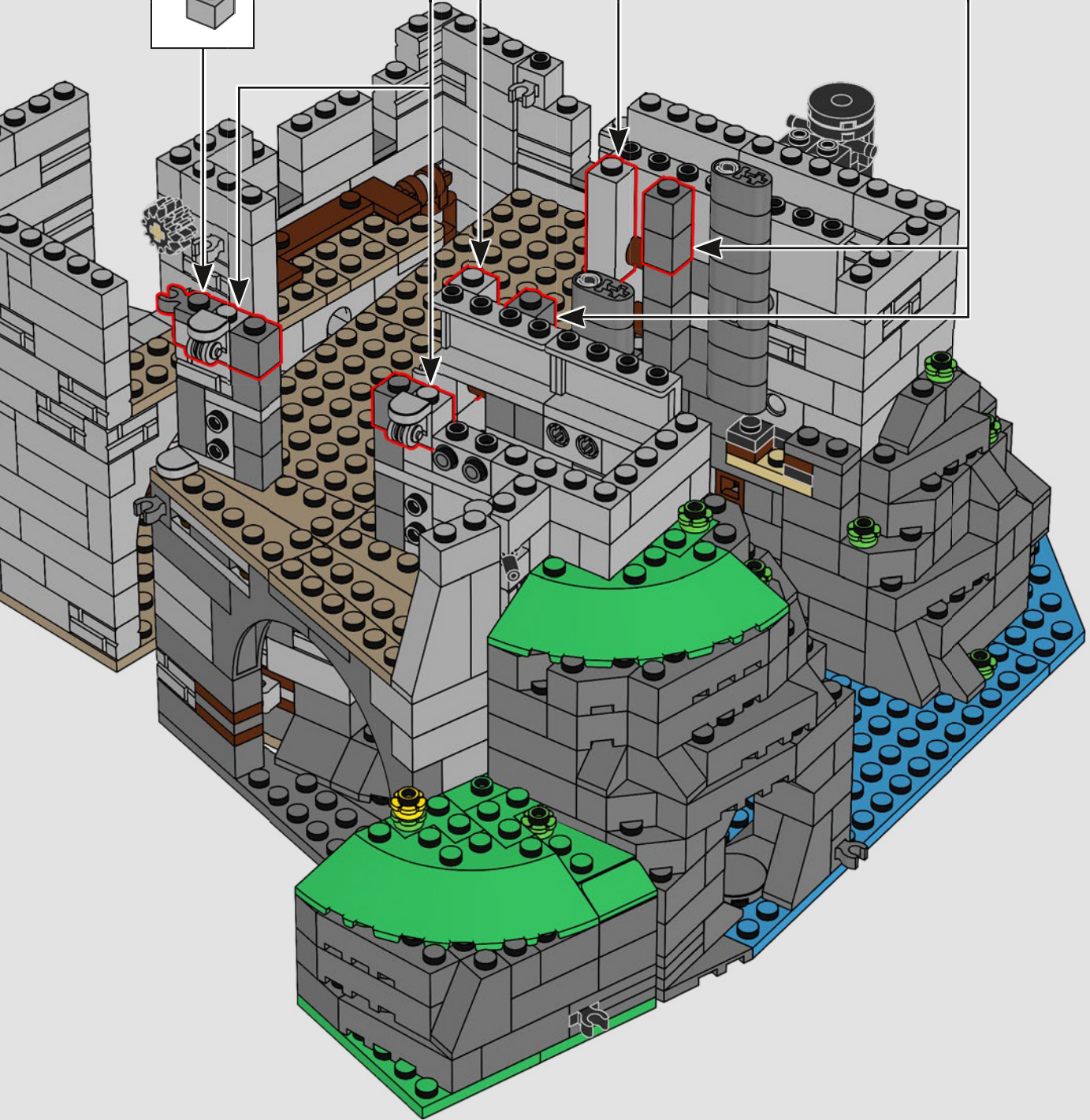
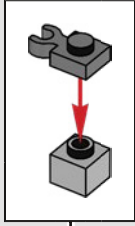
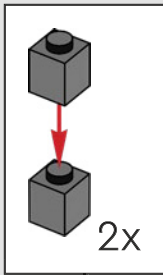
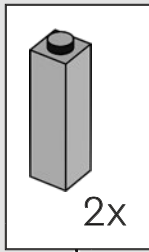
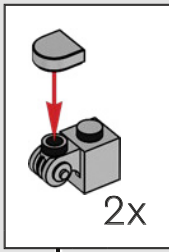

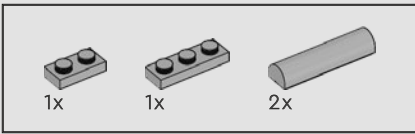

414

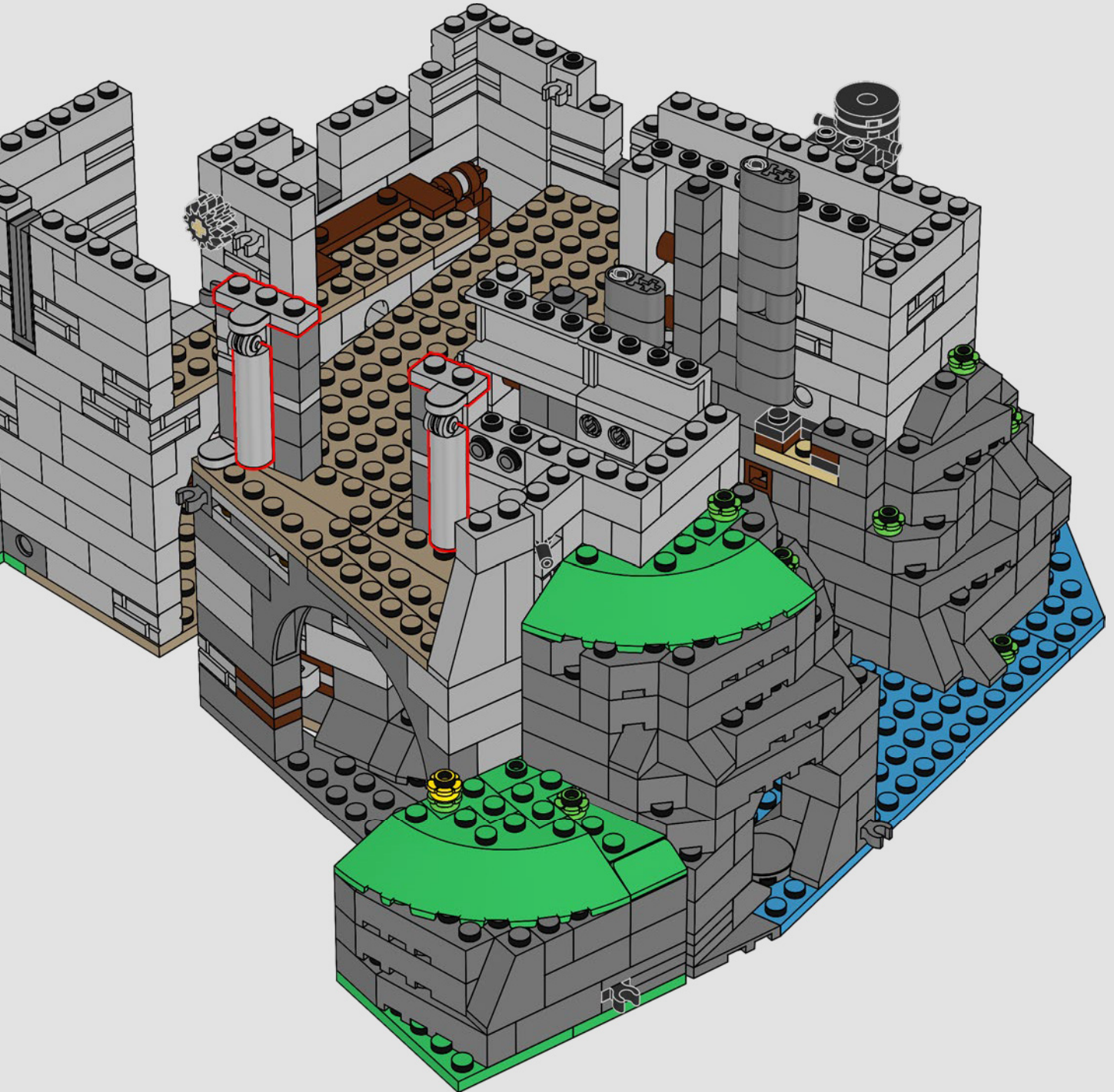



1x

415

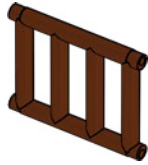

What a fine stall for our Lady's destrier! Methinks he would even fit in there wearing his caparison!

Quel bel étable pour le destrier de notre dame ! Je pense qu'il pourrait même y entrer en portant son caparaçon !

Qué potro tan noble para convertirse en el corcel de nuestra señora. ¡Creo que hasta podremos vestirlo!

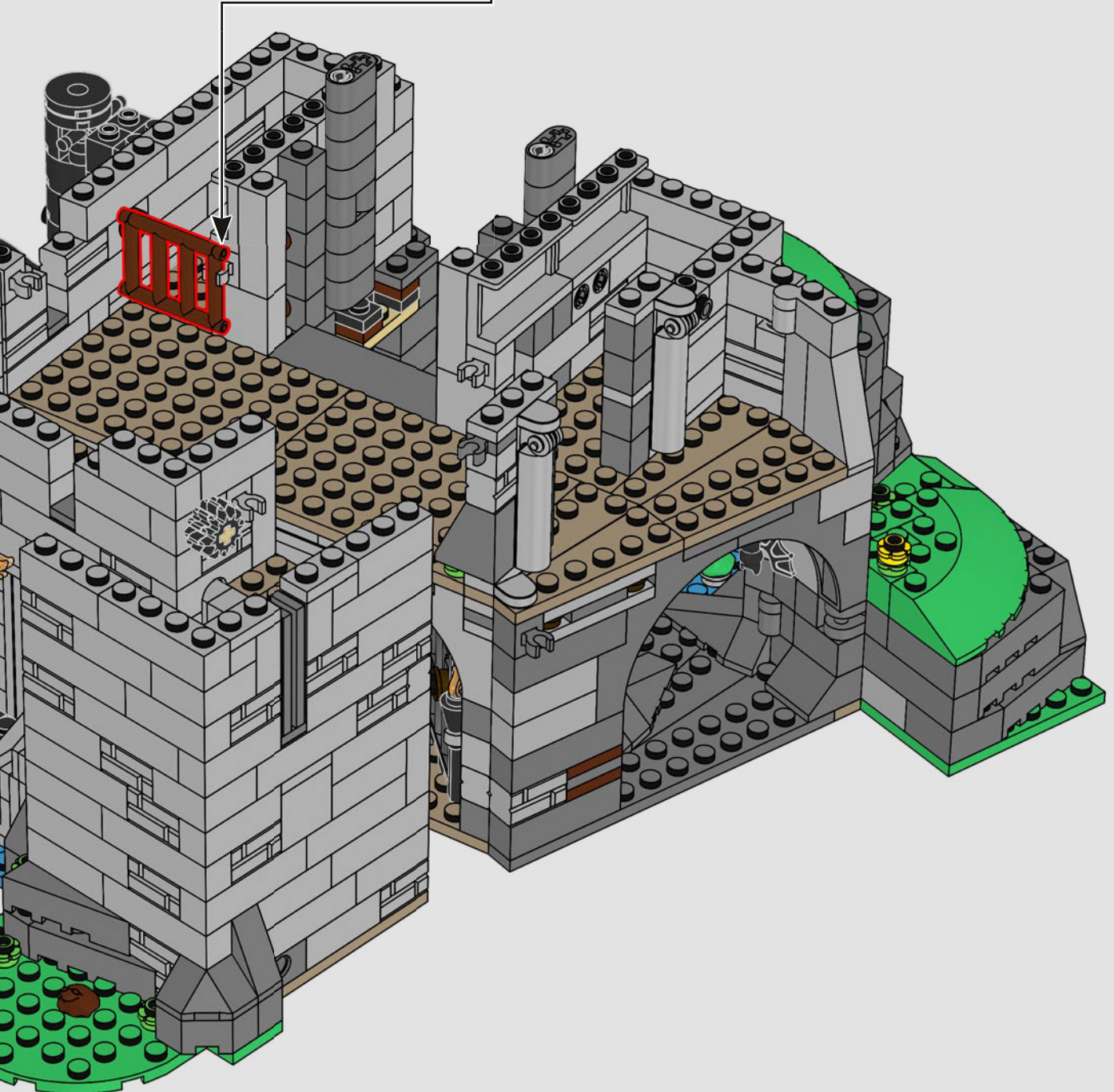

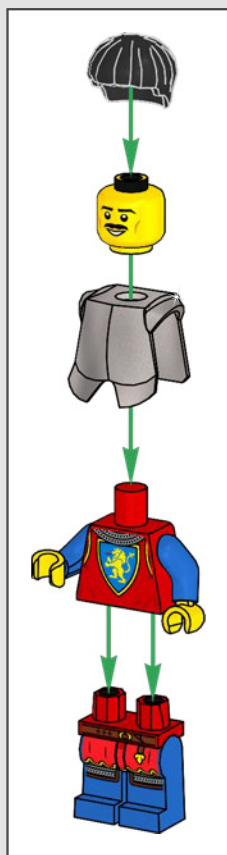

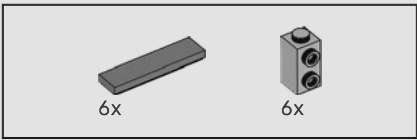

416

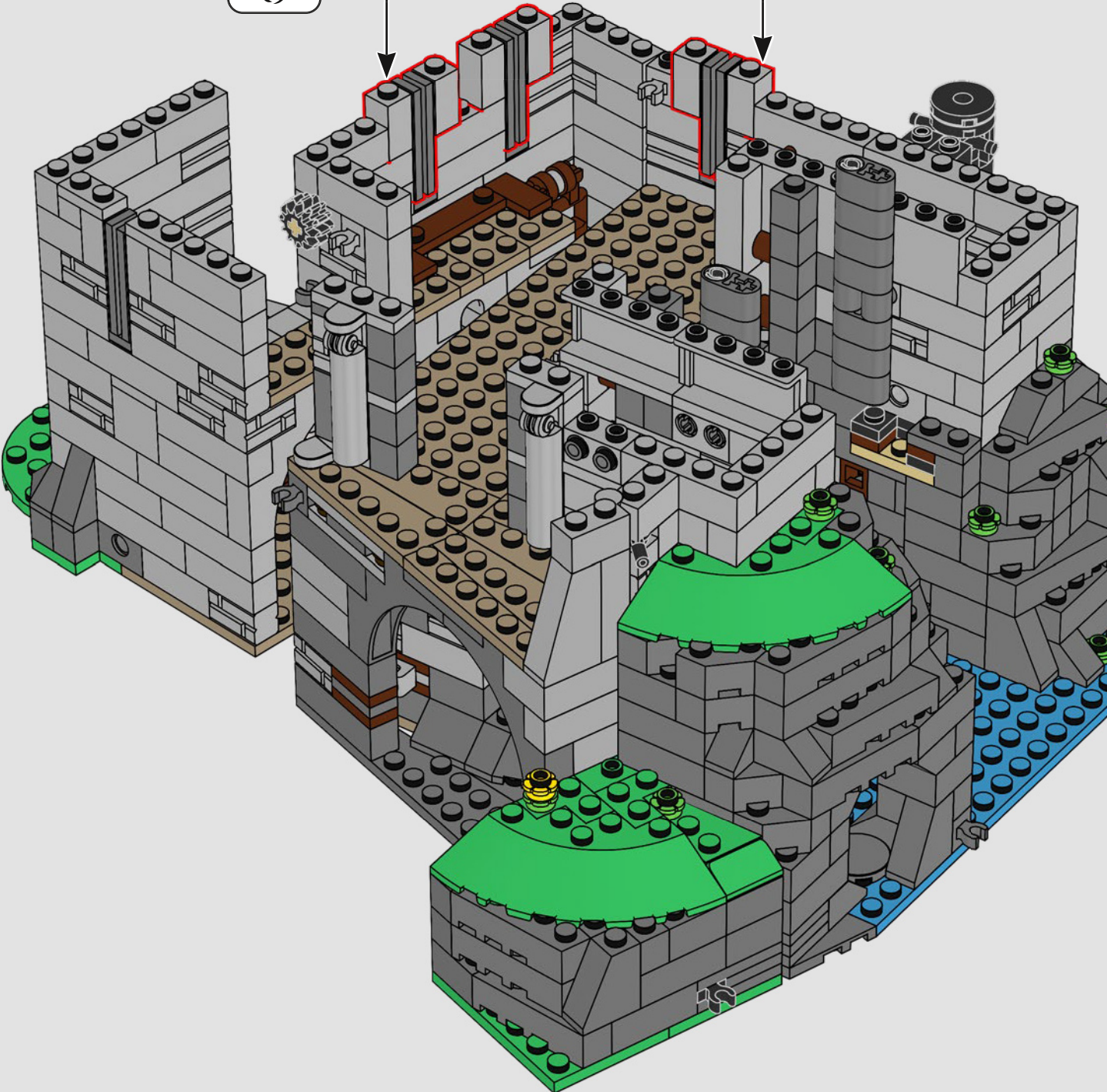
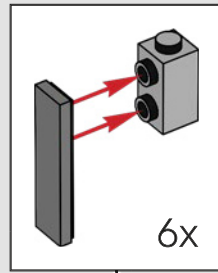

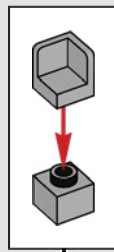
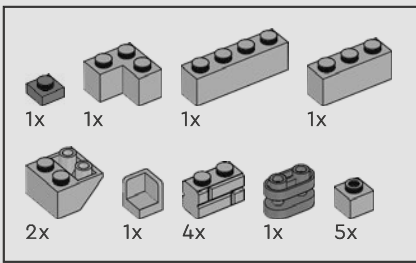

417

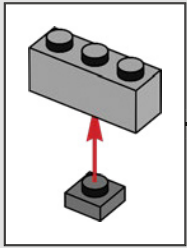

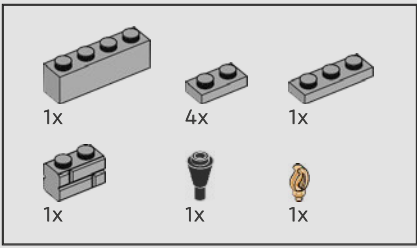

418

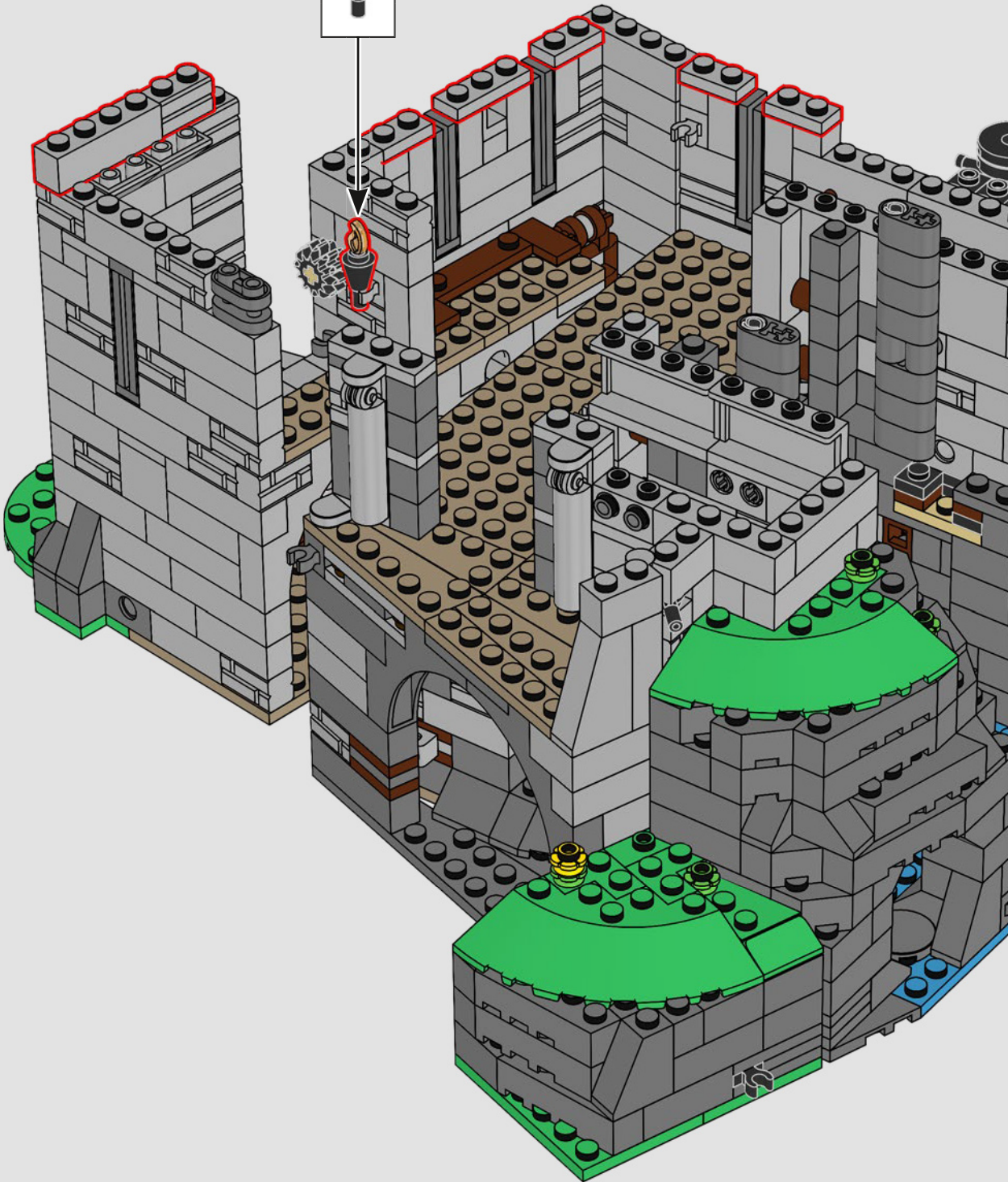

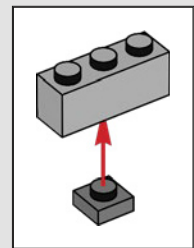
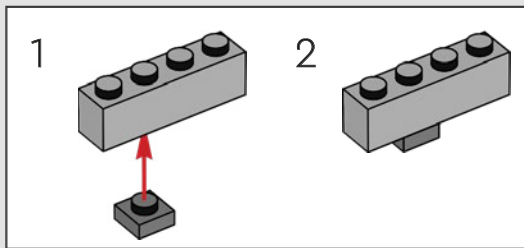
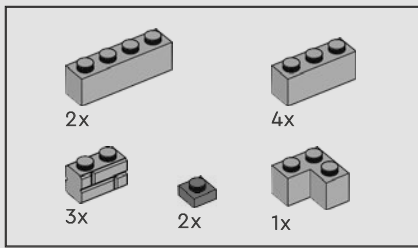

419

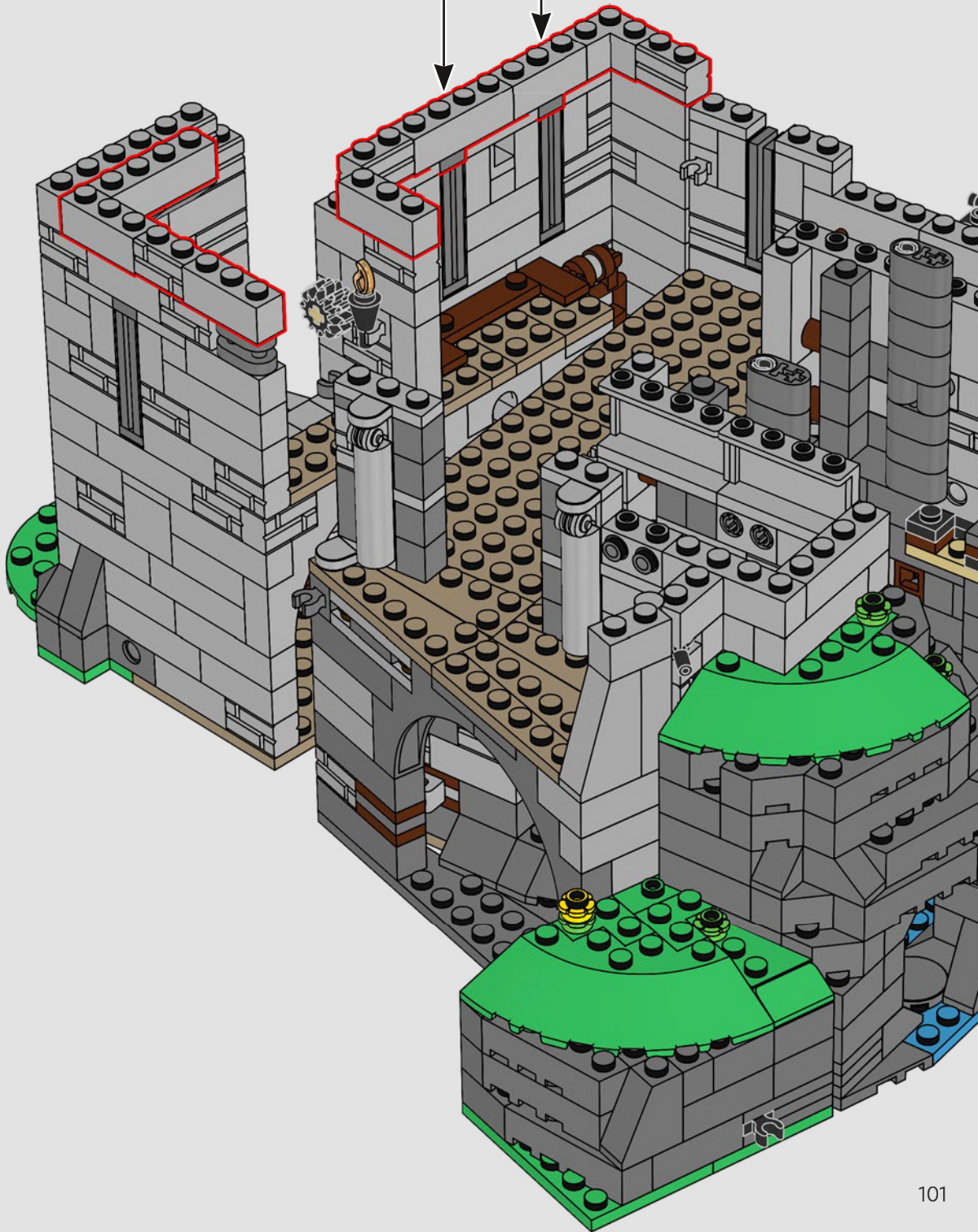

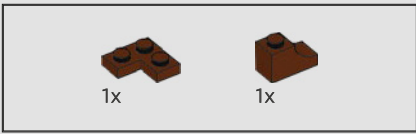

420

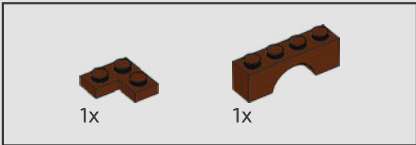
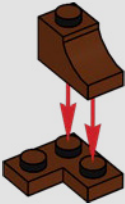

421

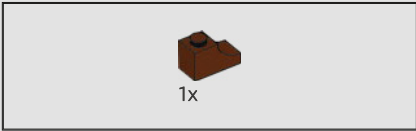
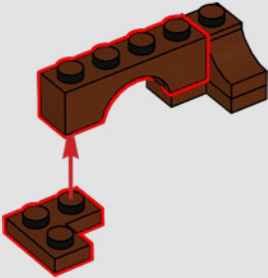

422

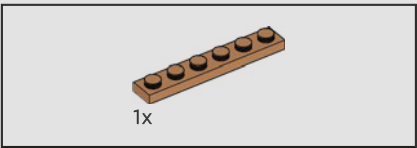
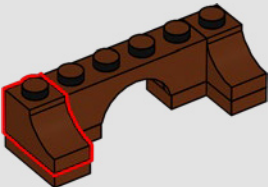

423

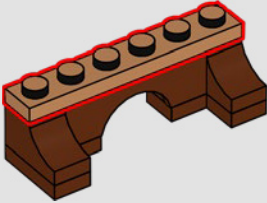

424

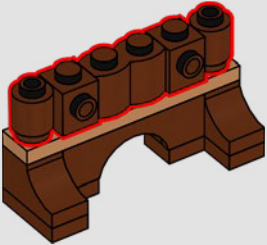

425

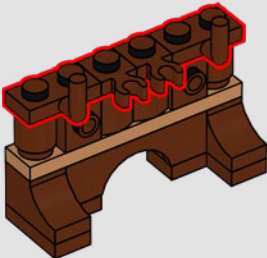

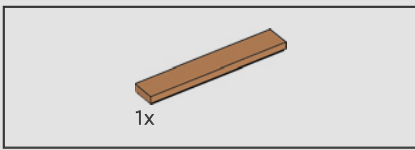

426

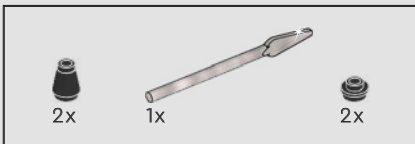
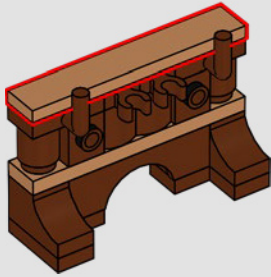

427

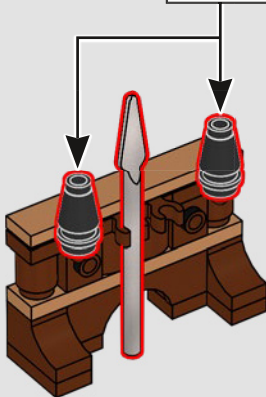
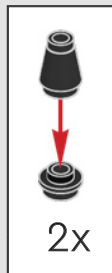

428

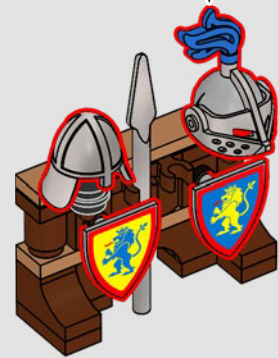
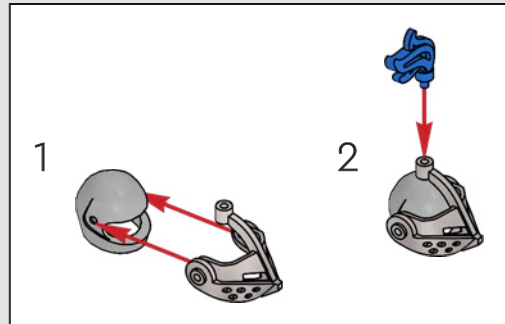

Which to choose? A sturdy armet or a nasal helm??
I've always fancied a pointed hat!

Lequel choisir ? Une armure solide ou un casque nasal ? J'ai toujours eu envie d'un chapeau pointu !

¿Cuál elegir? ¿Un sólido almete o un casco con nasal? ¡Siempre quise un sombrero puntiagudo!

429



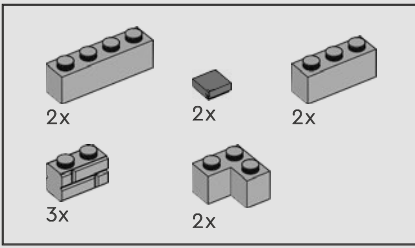

430

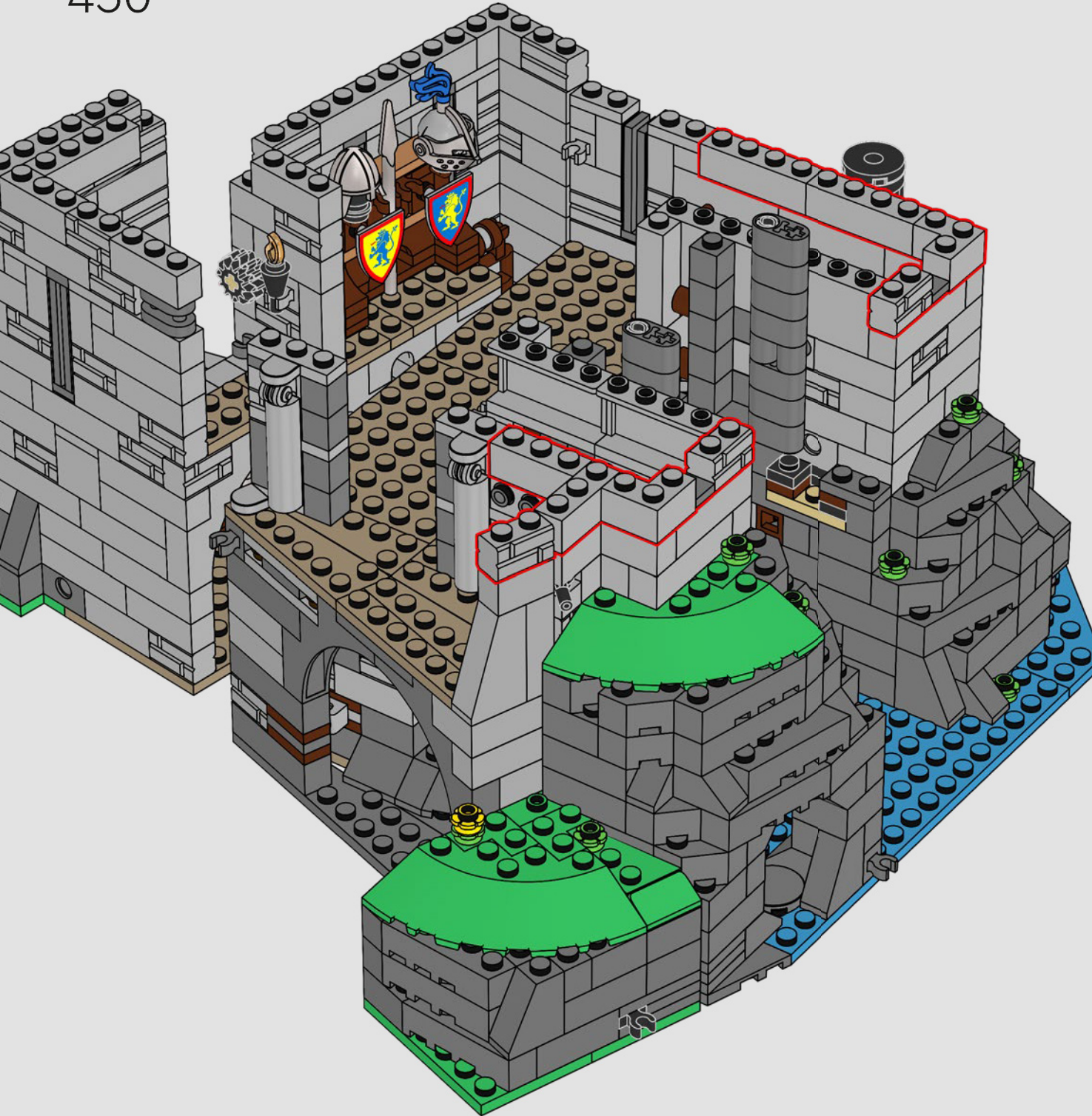

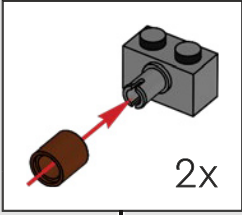
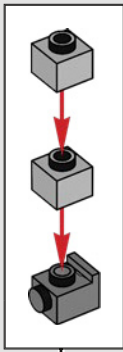
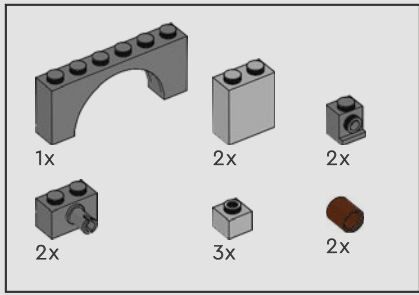

431



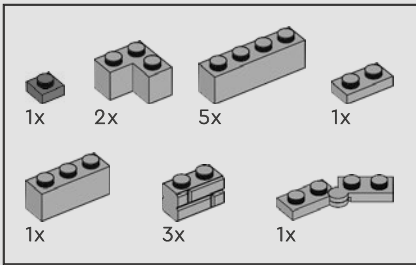

432

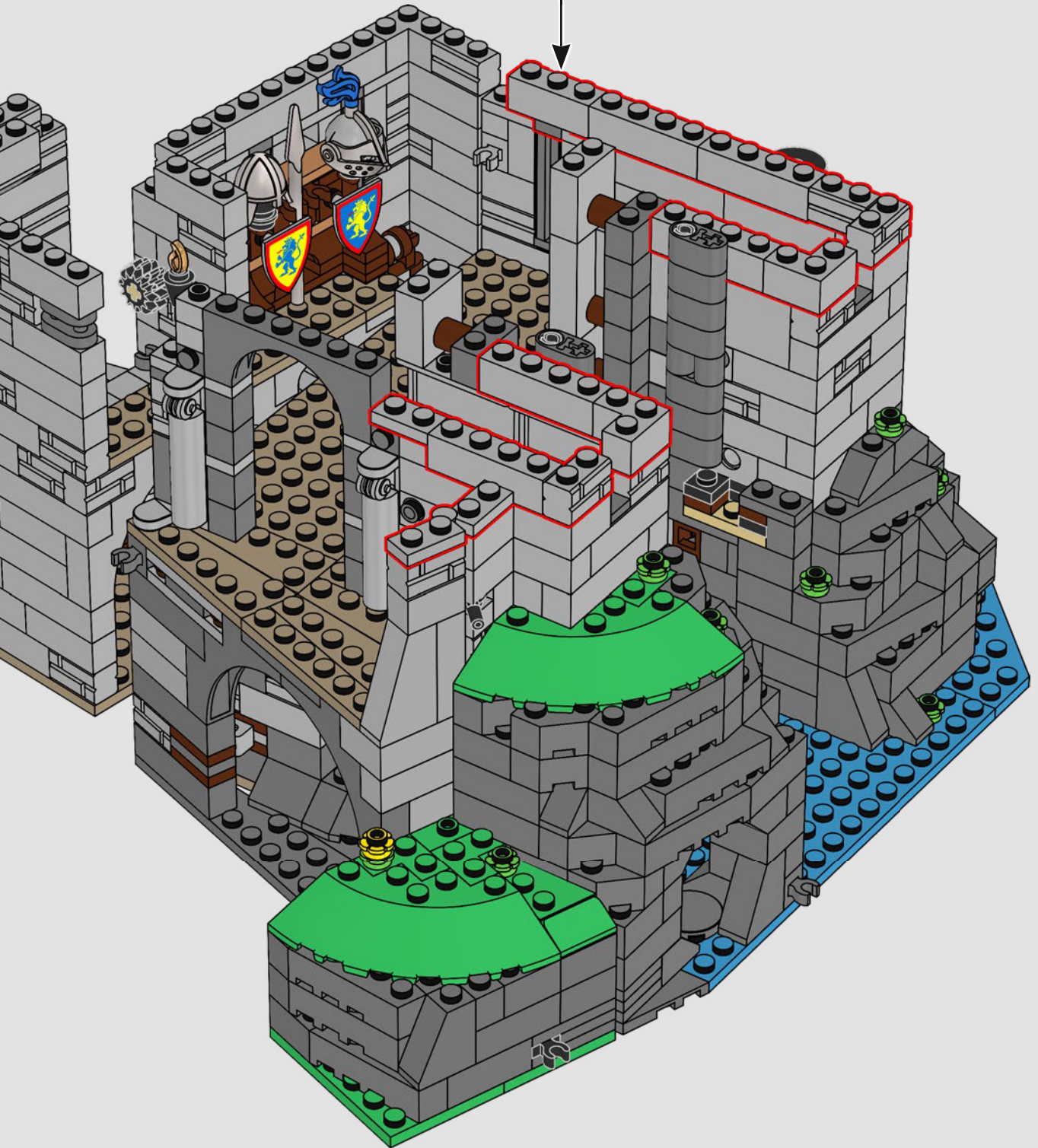
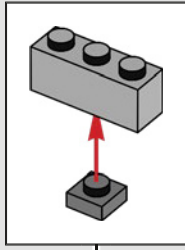

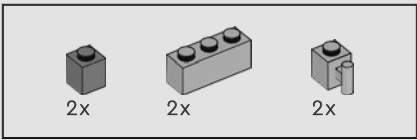

433

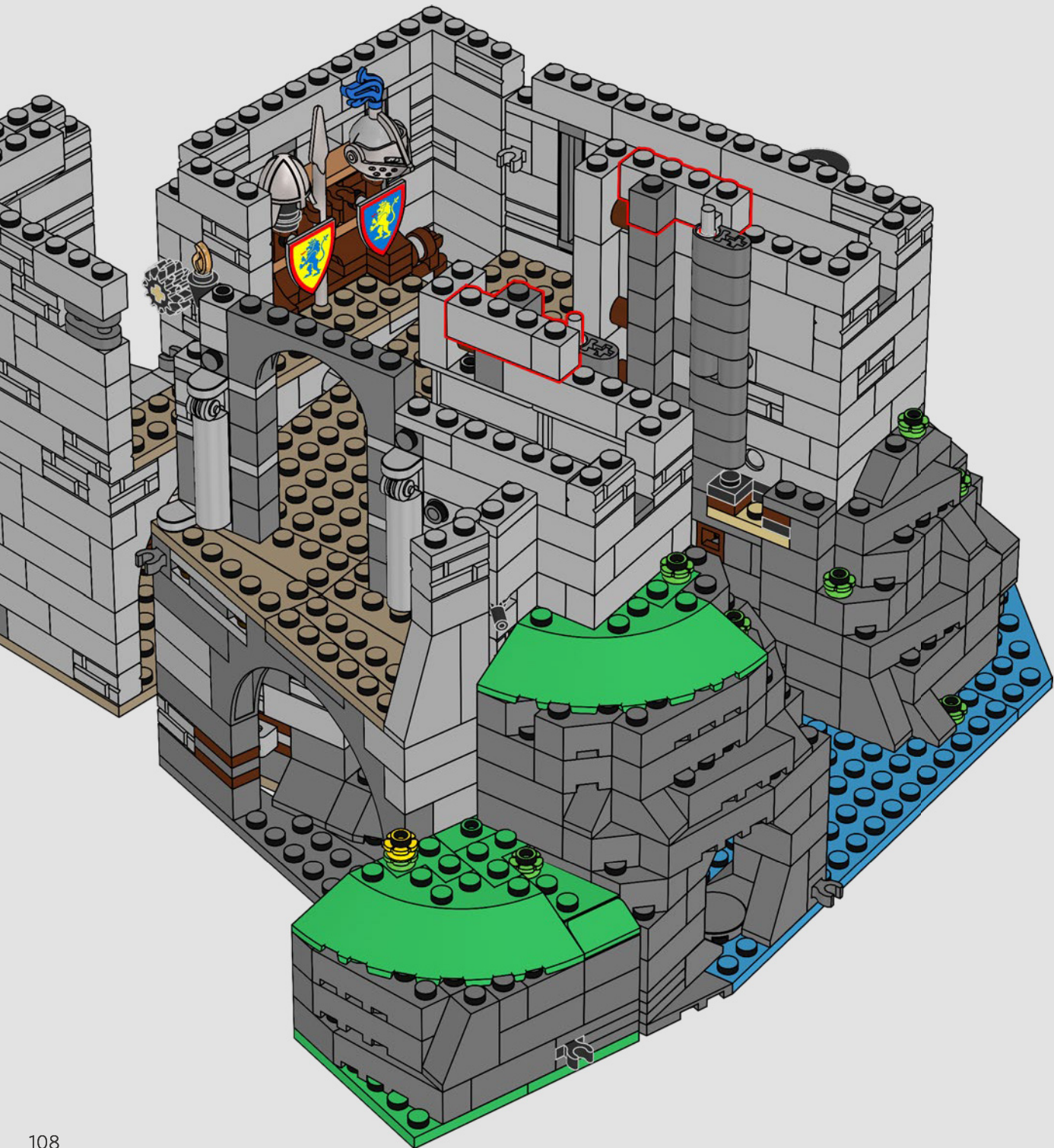

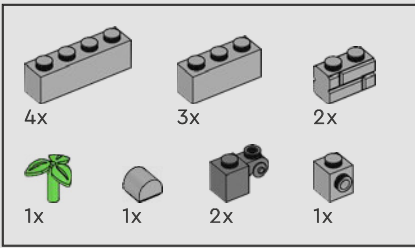

434

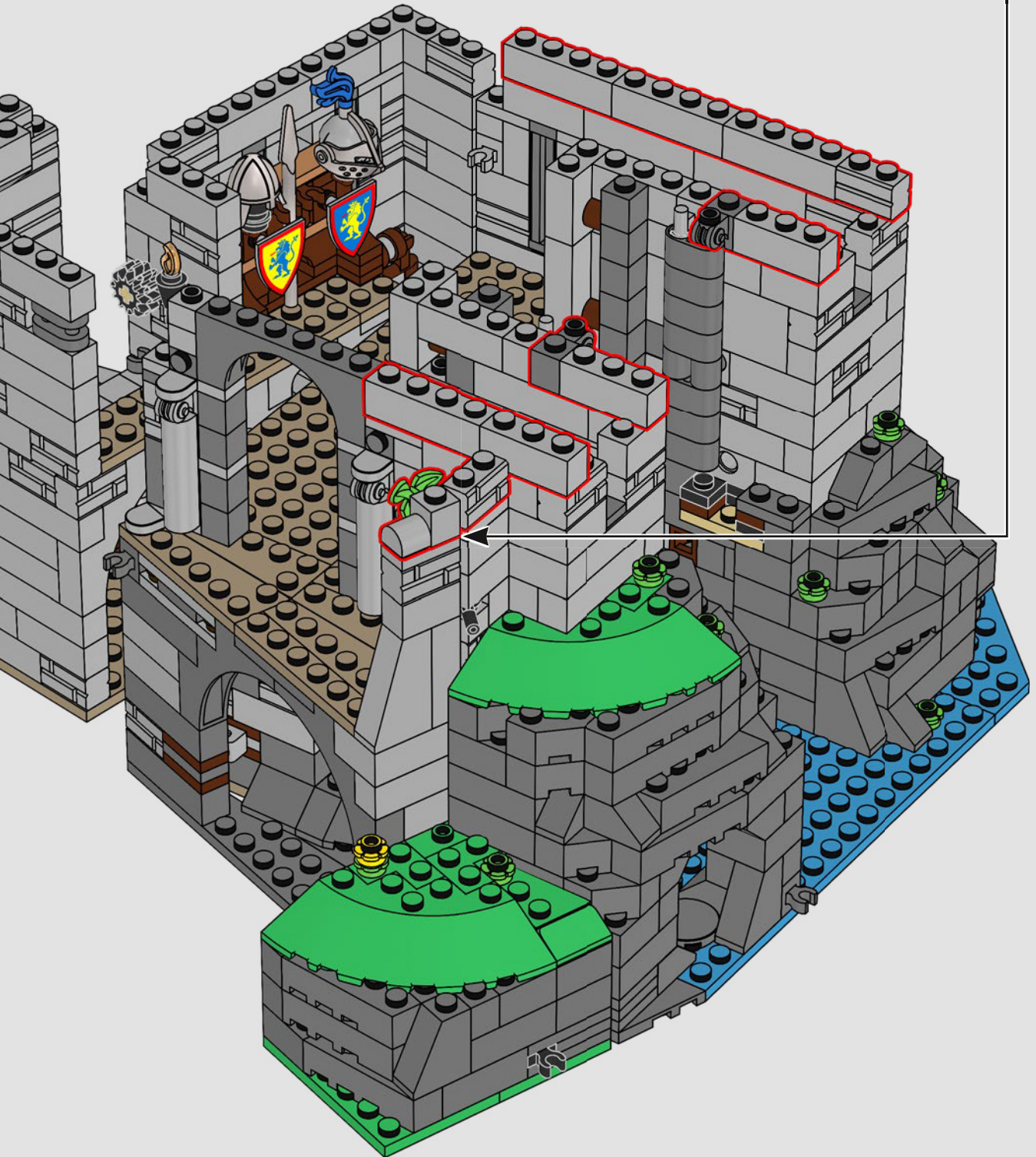
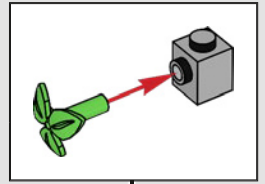

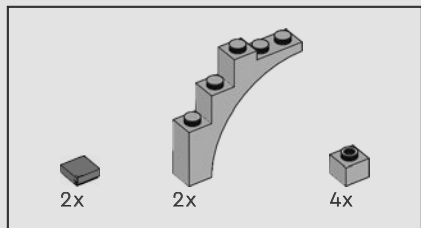

This stone here seems too short to be a proper brick, though at the same time too tall to be a plate; perhaps I'll call it a block...

Cette pierre-ci semble trop courte pour être une vraie brique, mais aussi trop haute pour être une plaque; je vais peut-être l'appeler un bloc...

Esta piedra parece demasiado pequeña para ser un brick, aunque, al mismo tiempo, es demasiado alta para ser una placa. Quizá deba llamarla "bloque"...

435

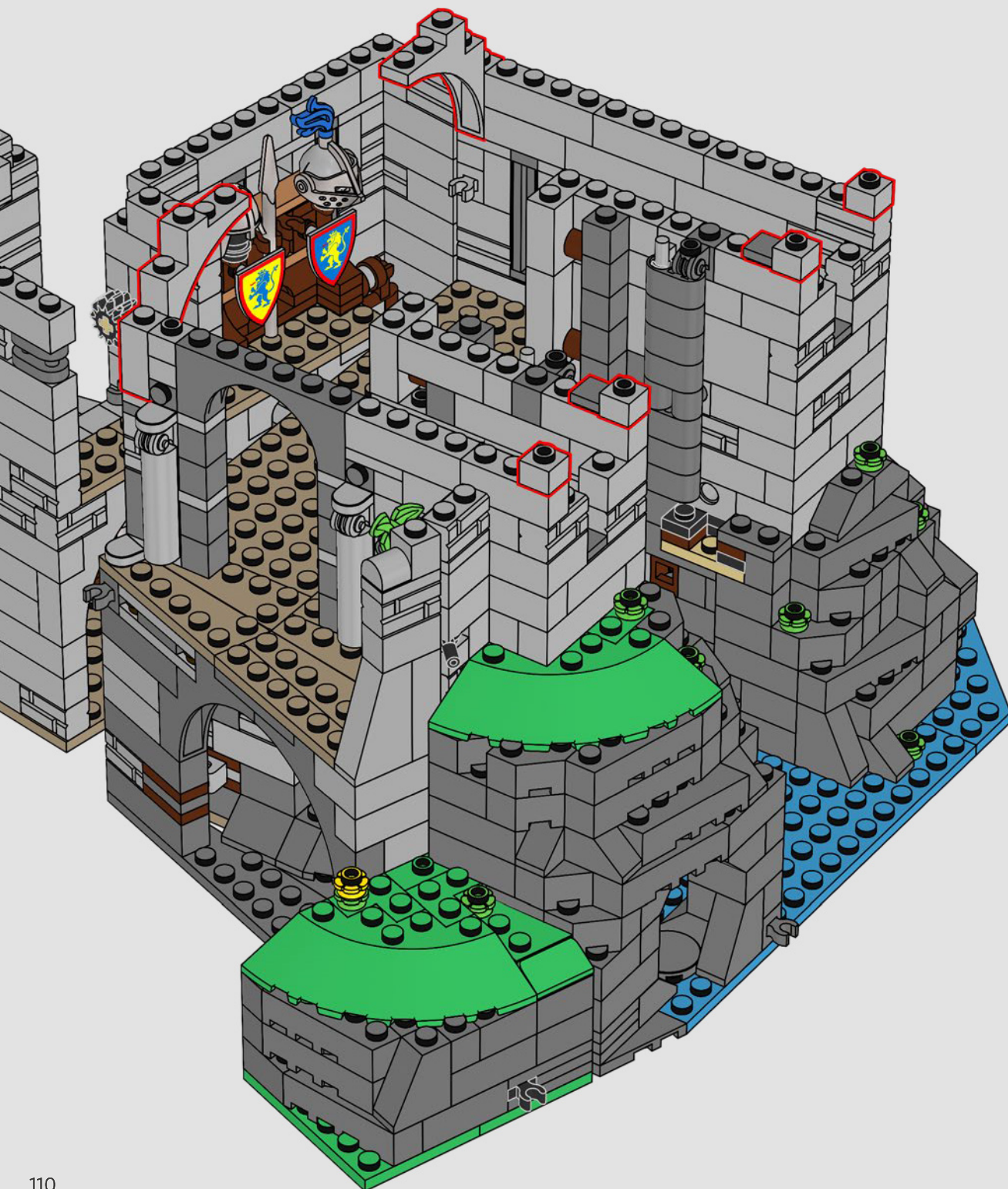

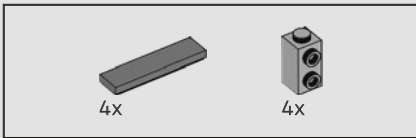

436

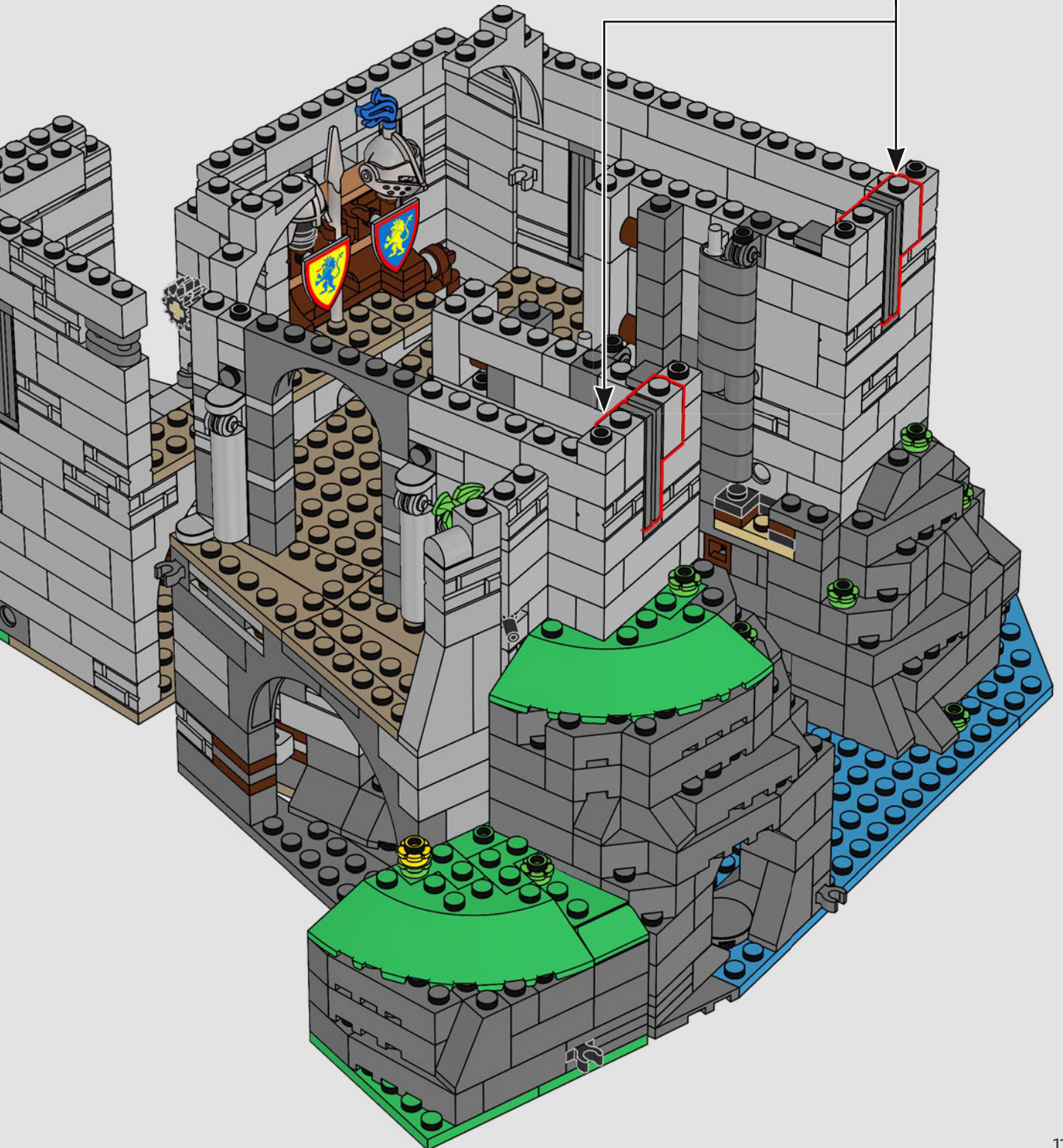
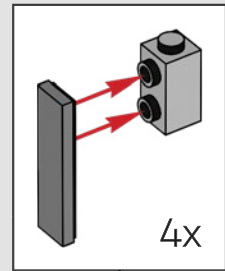

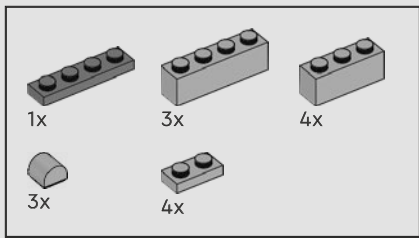

437

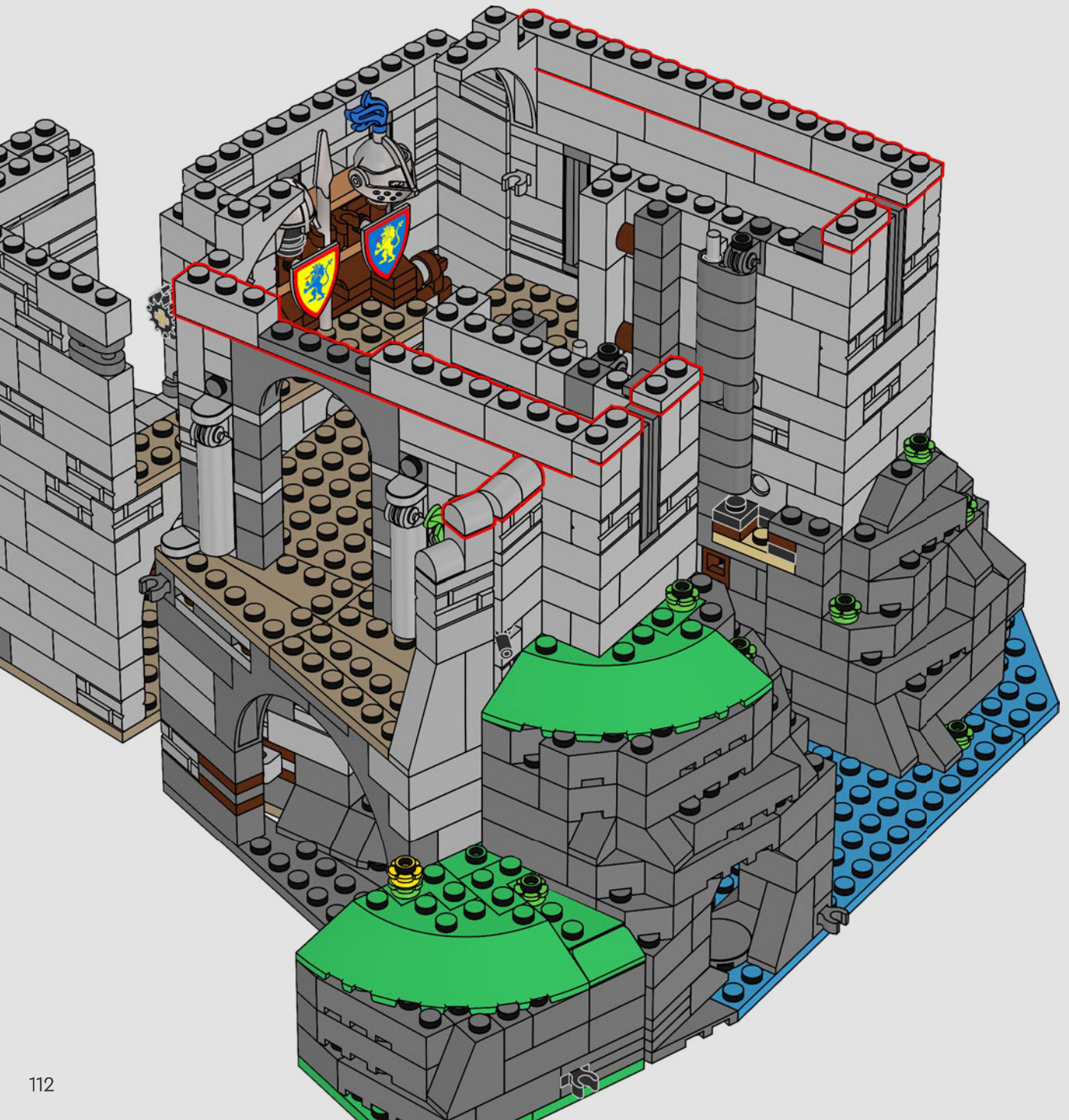

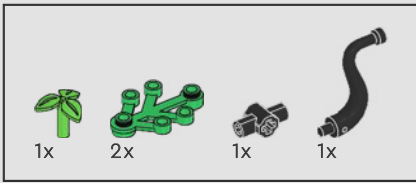

438

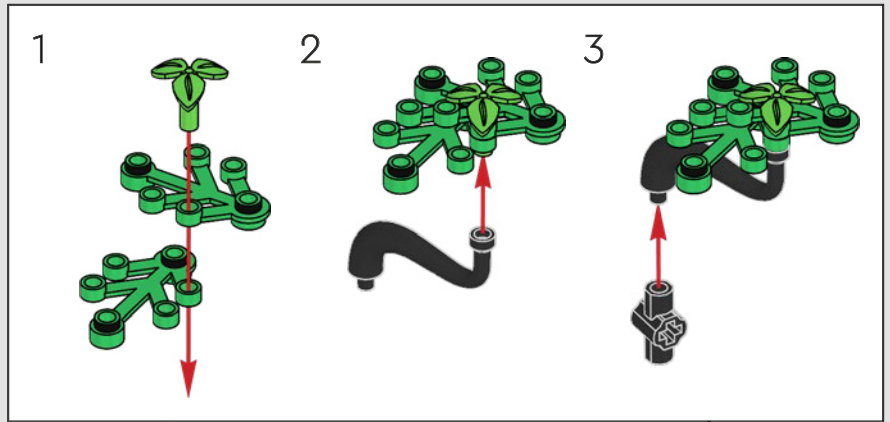

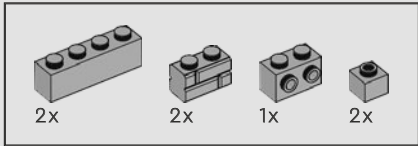

439



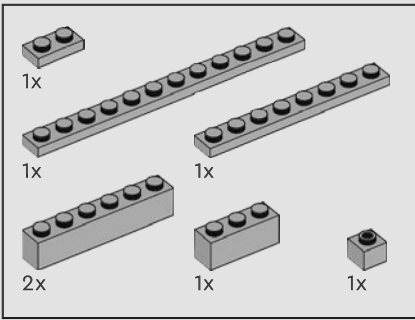

440

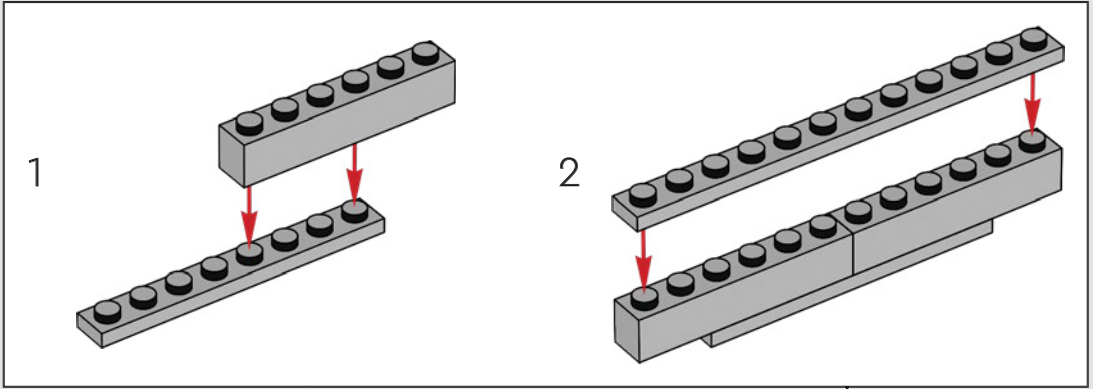

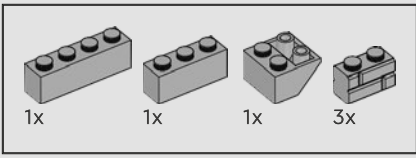

441

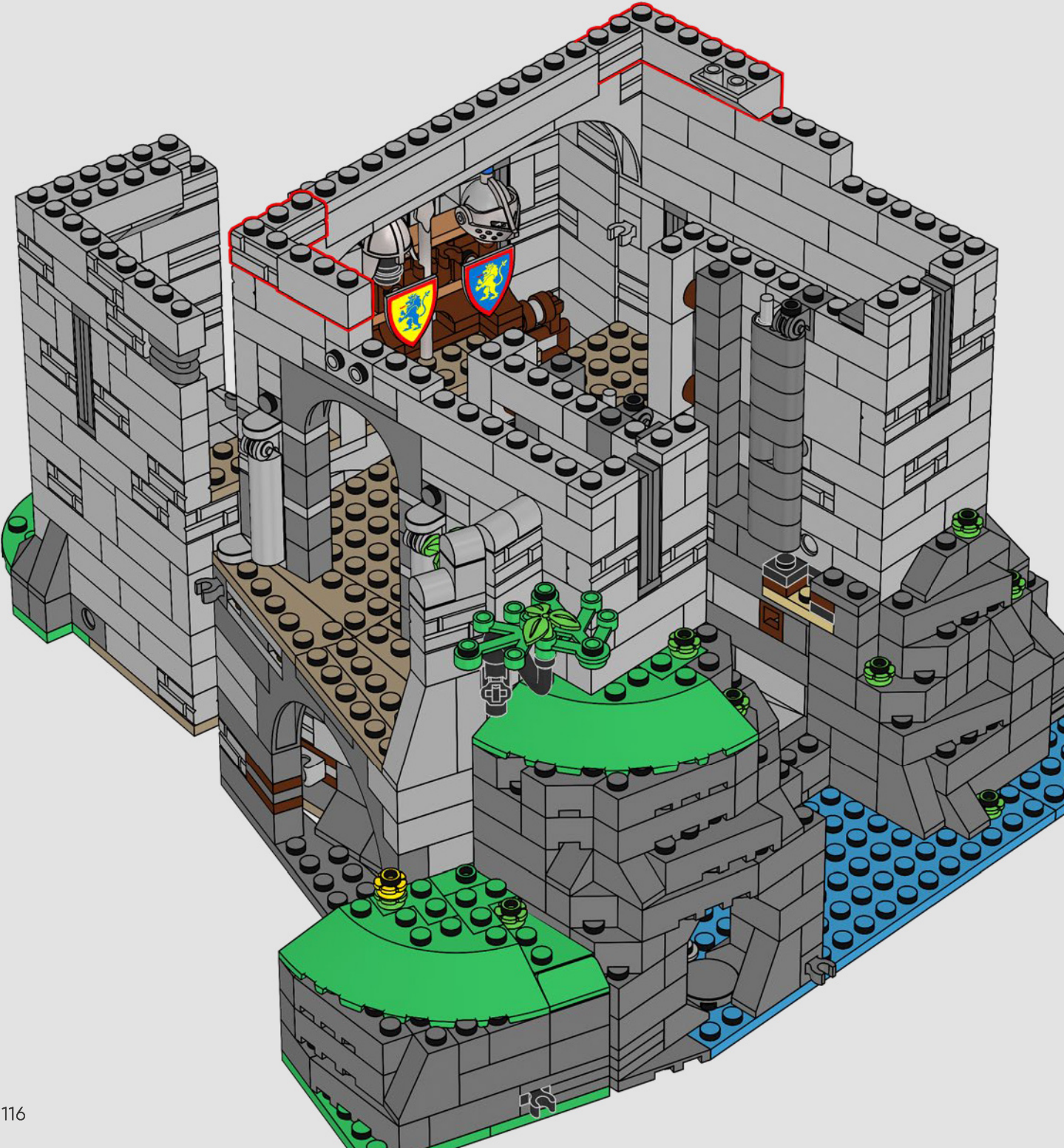

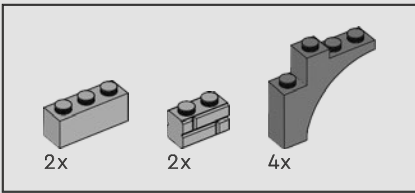

442

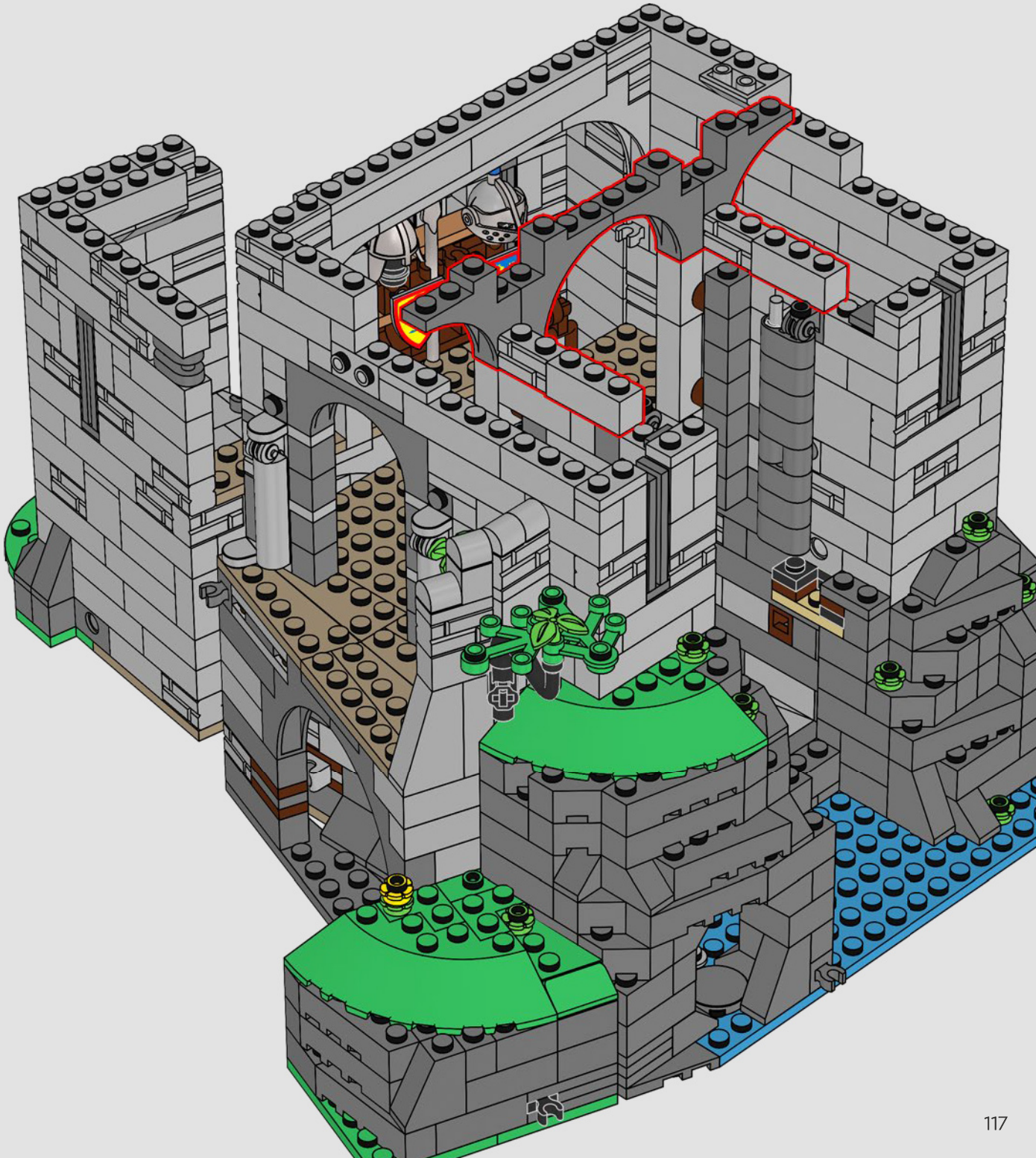

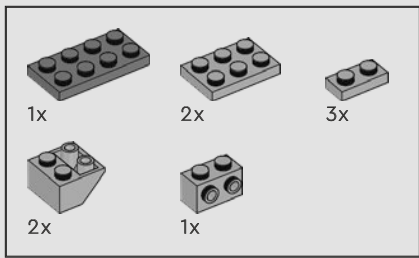

443

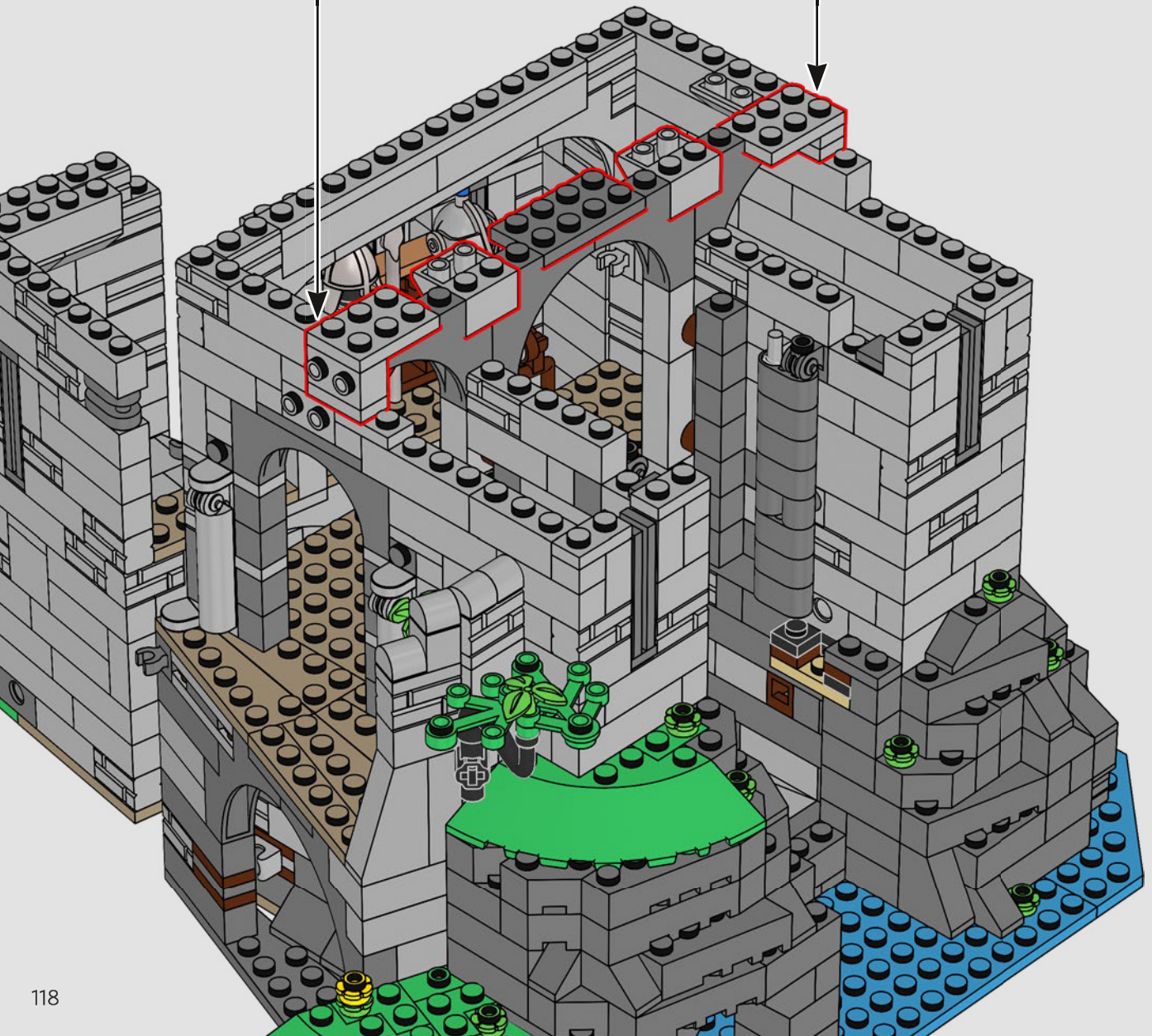
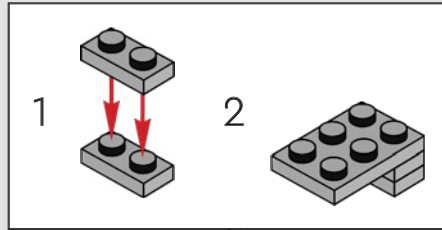
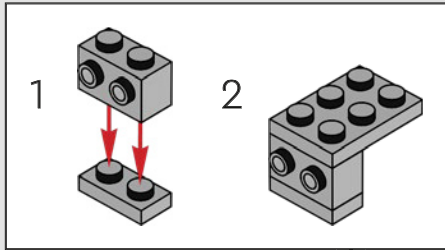

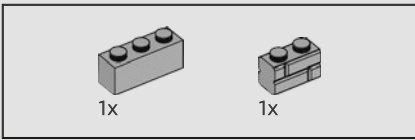

444

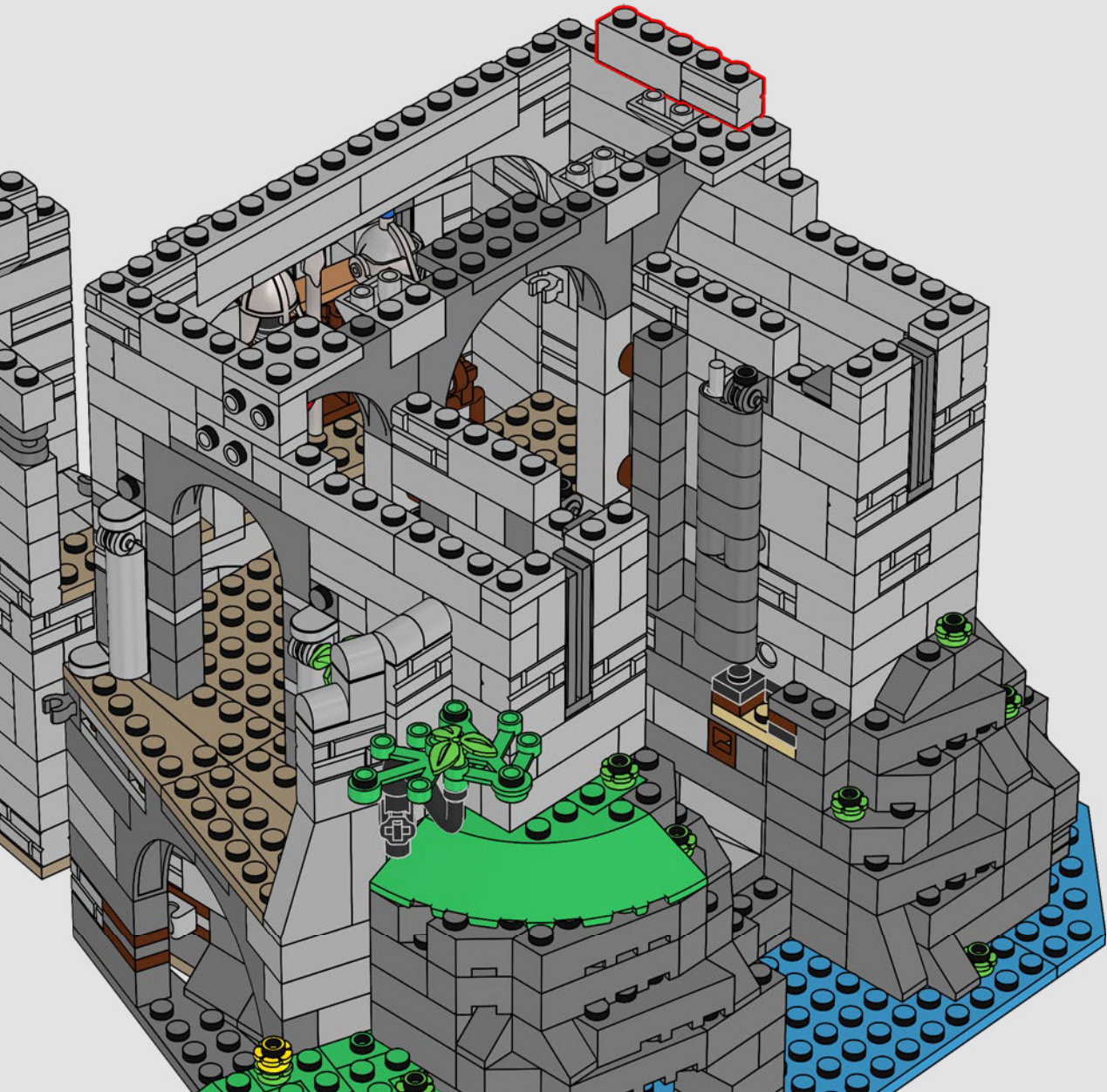

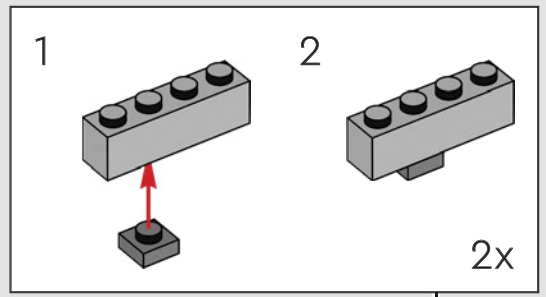
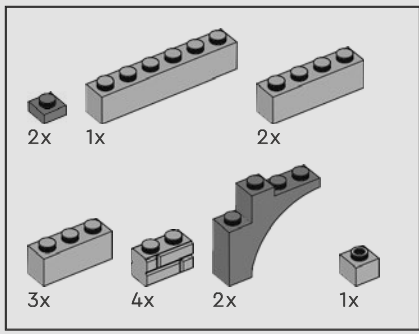

445

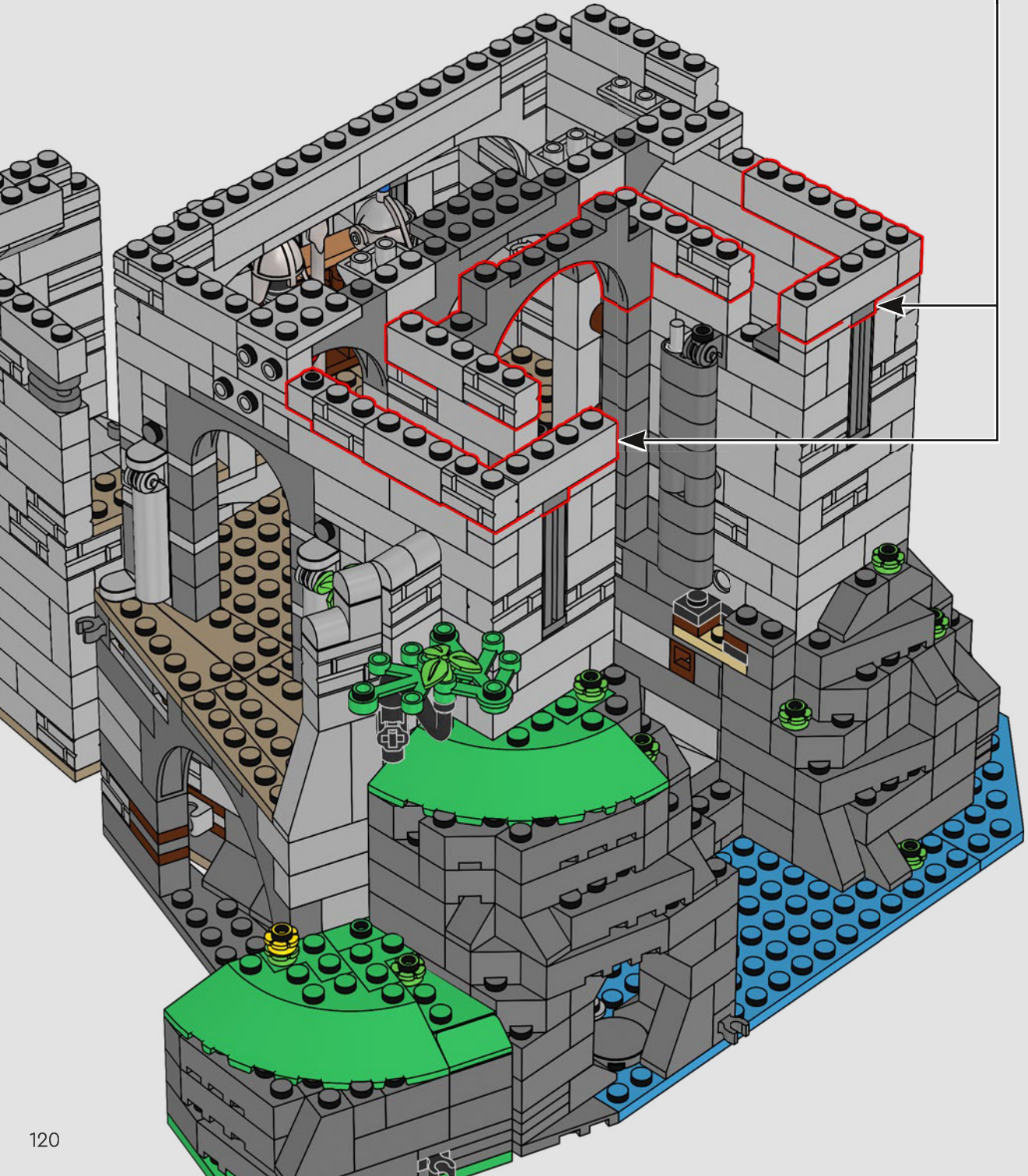

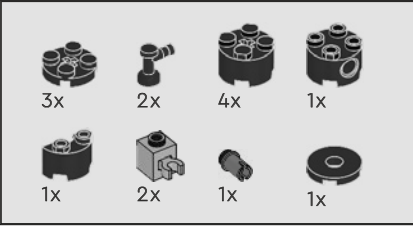
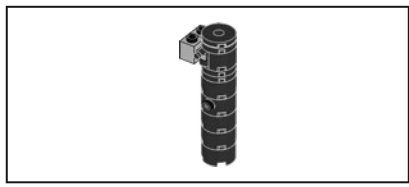

446

1



2

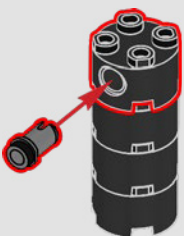

3



4



5



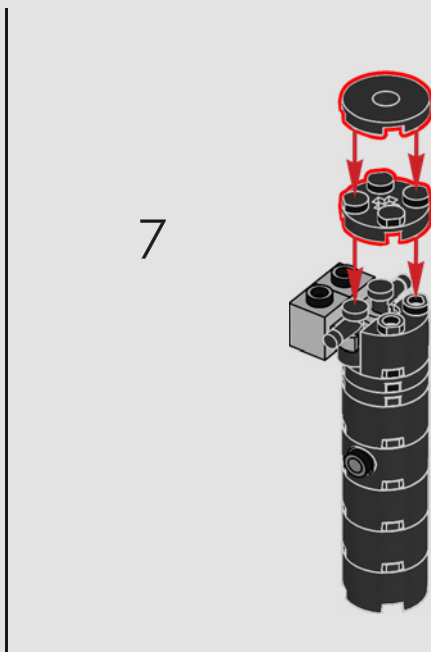
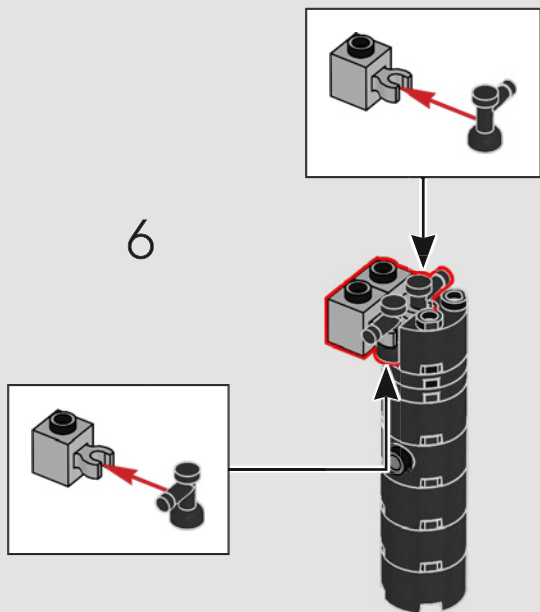

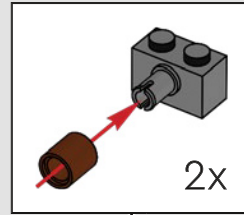
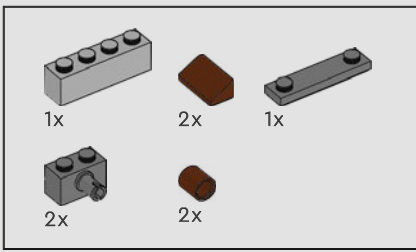

447

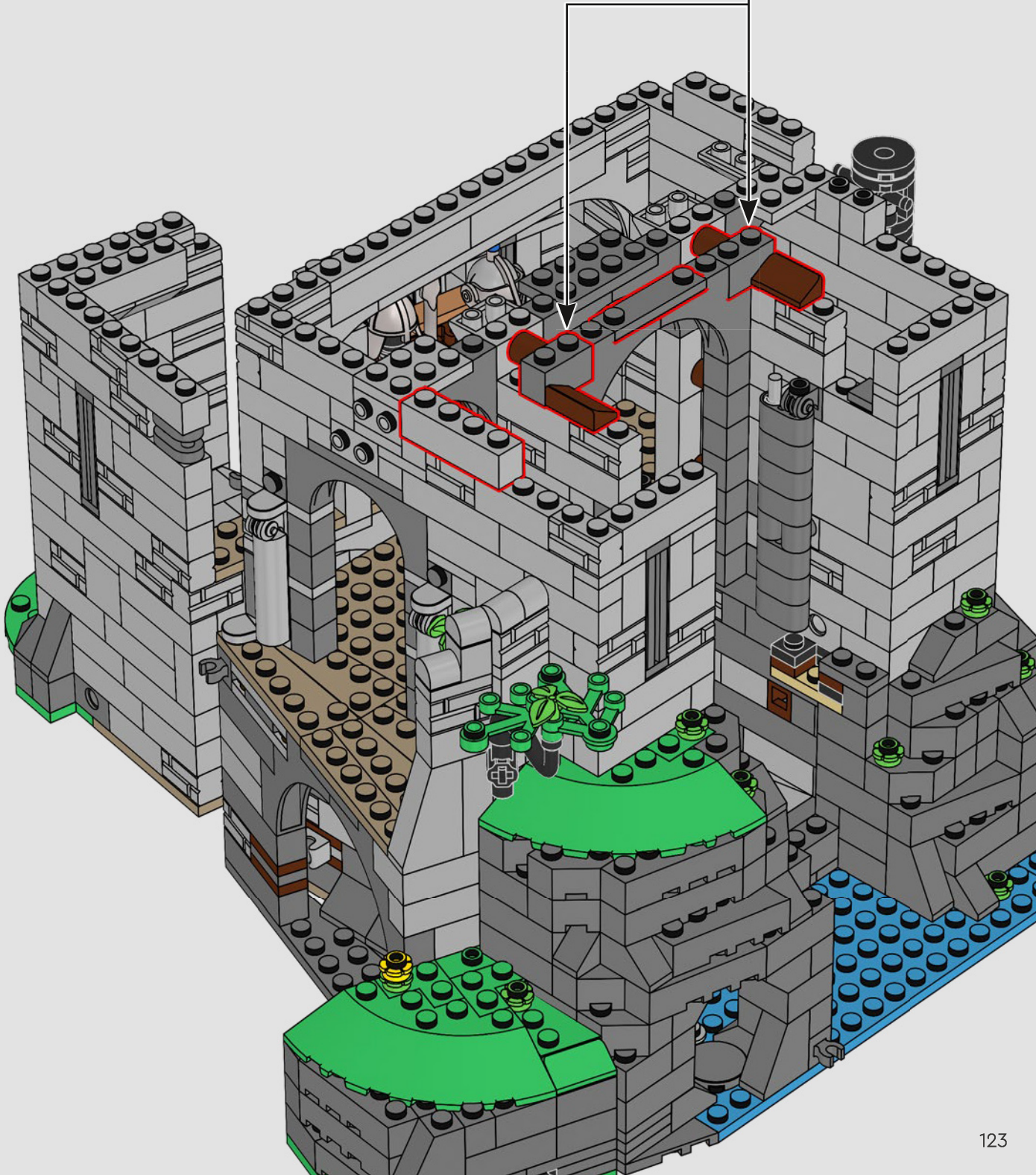



448

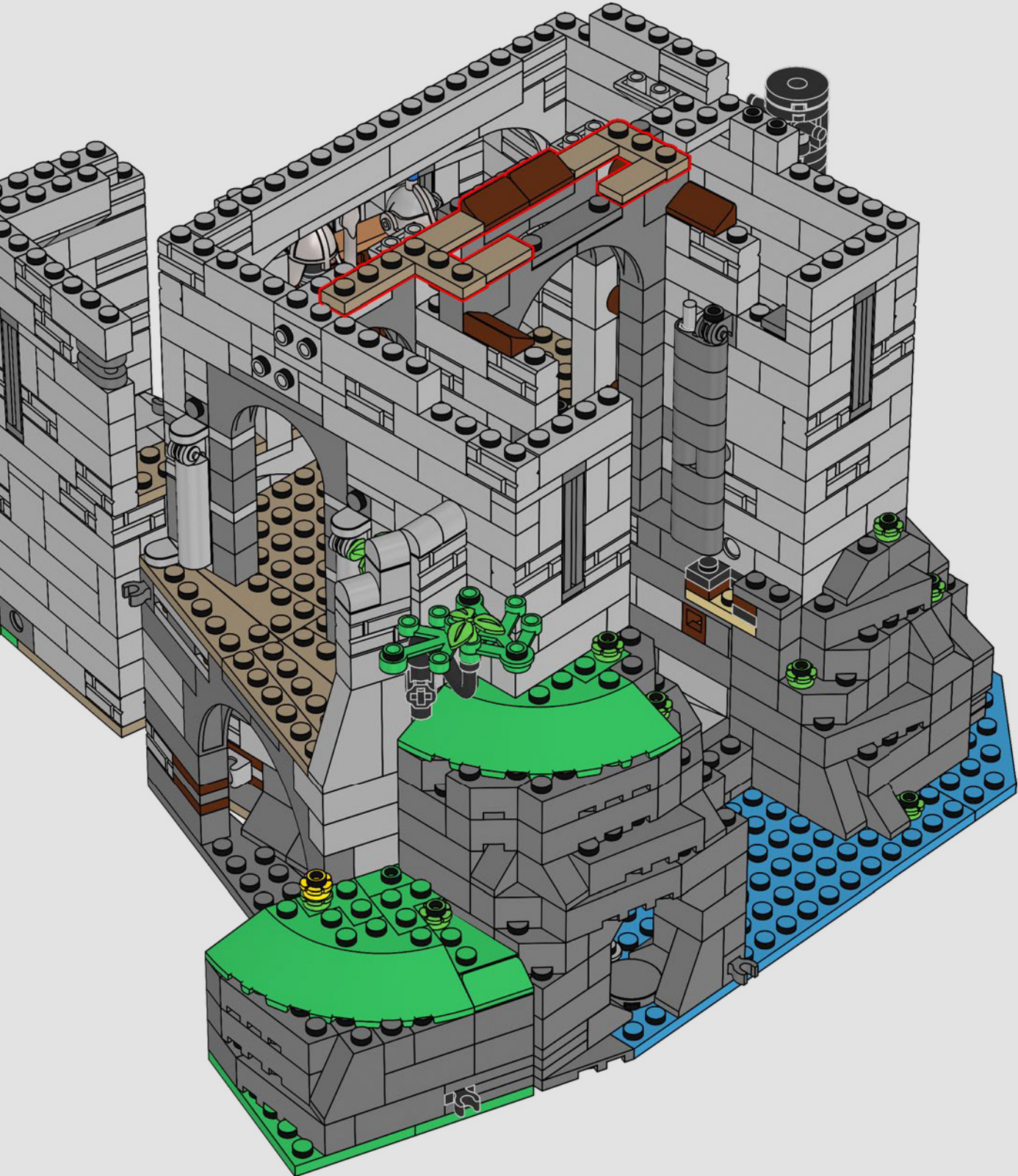

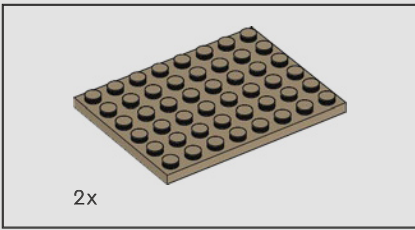

449

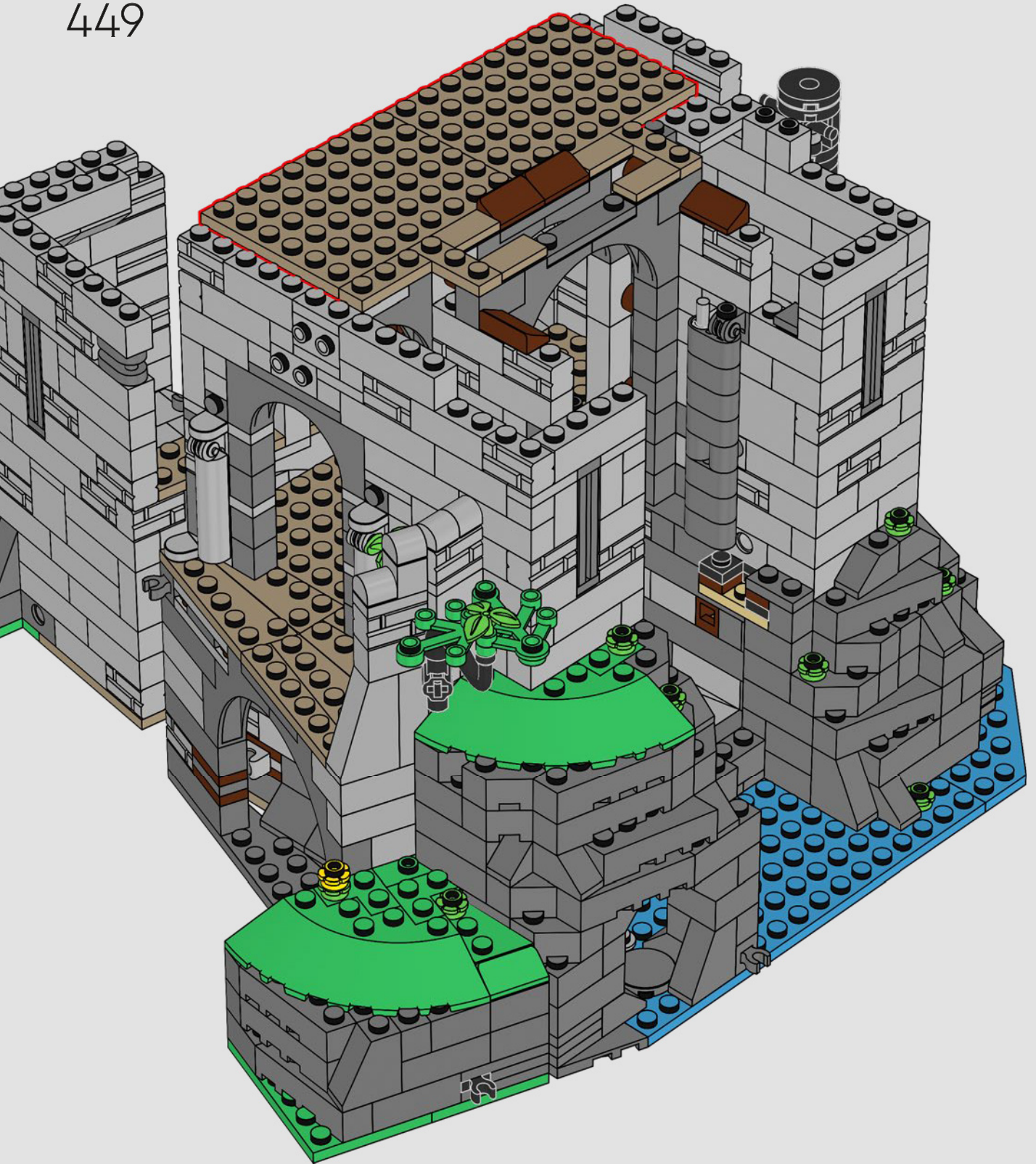

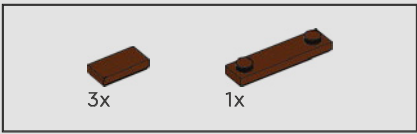

450

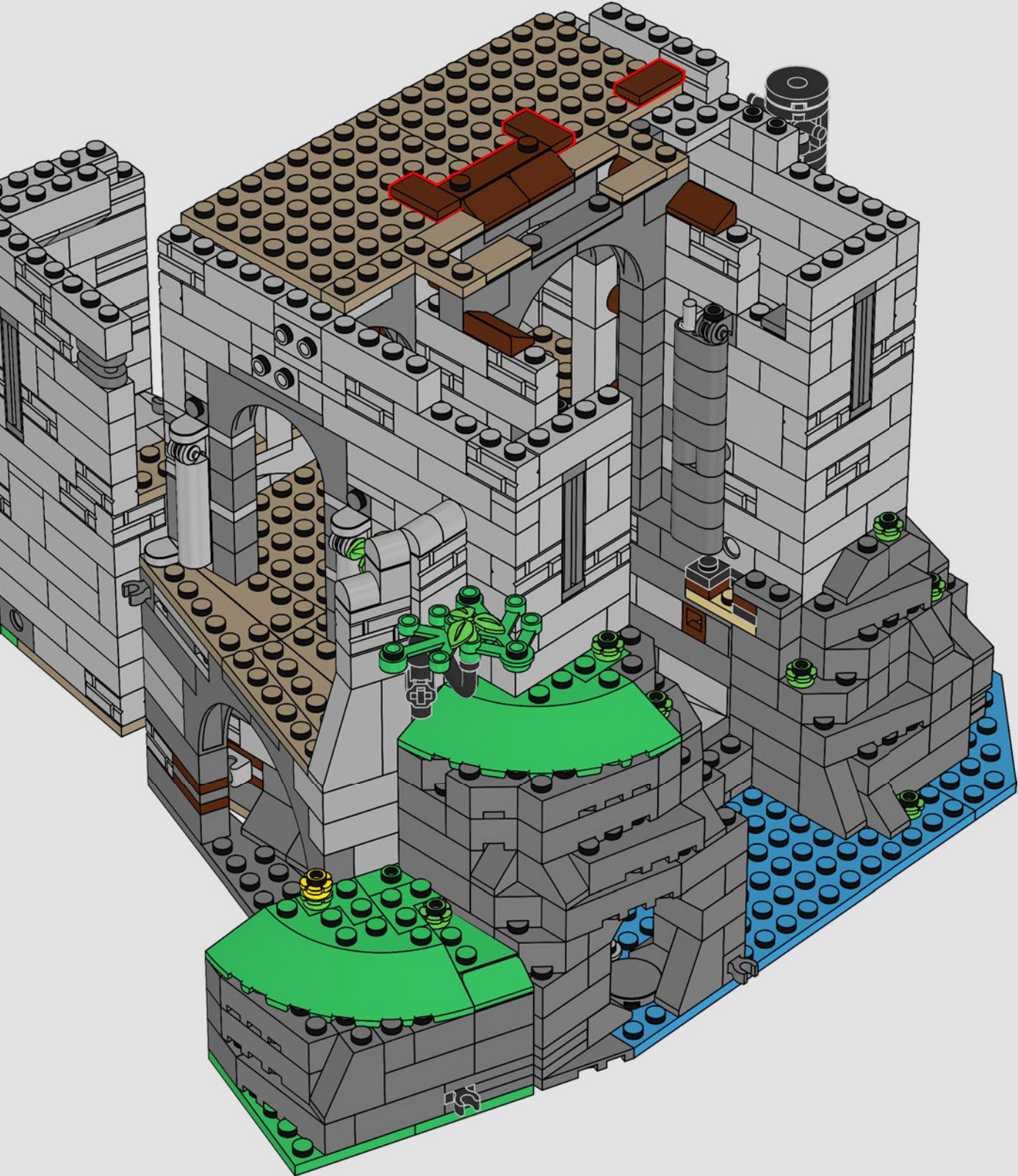

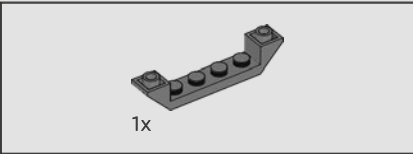
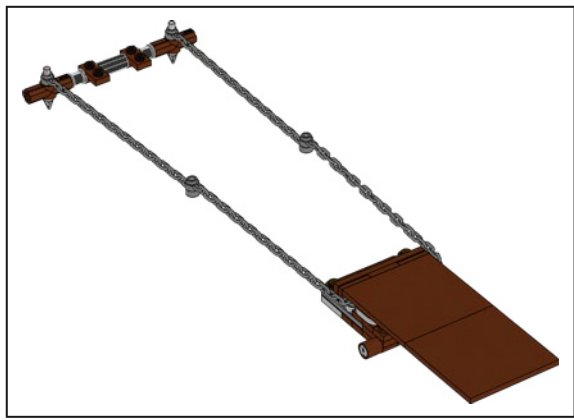

451

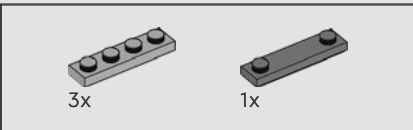
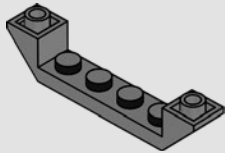

452

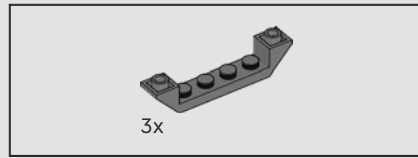
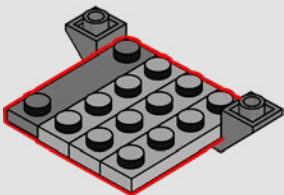

453

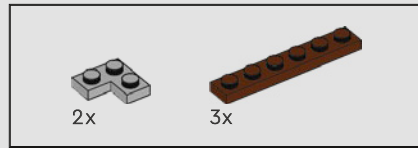
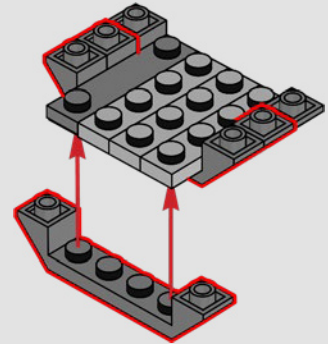

454

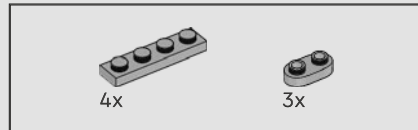
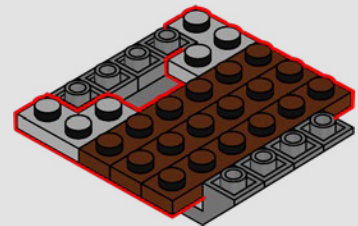

455

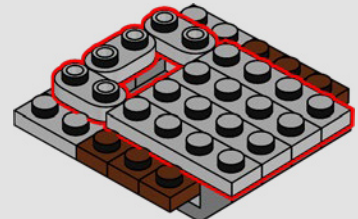

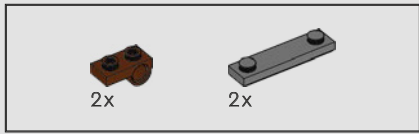

456

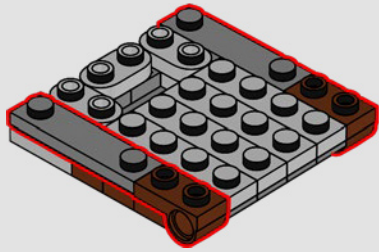

457

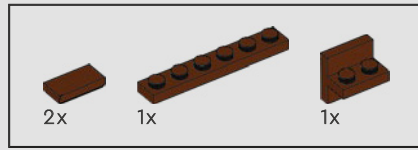
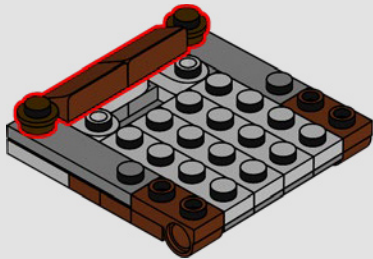

458

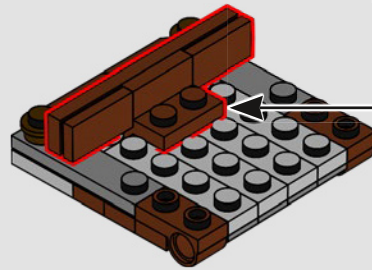
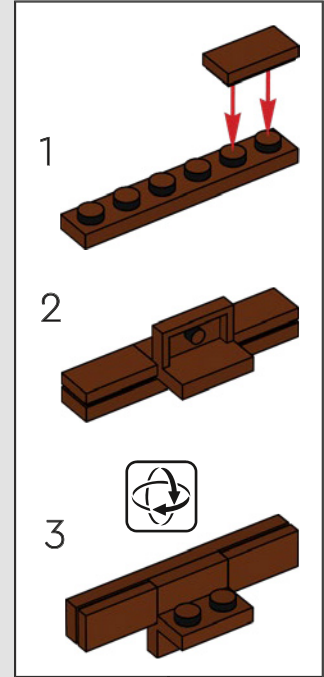

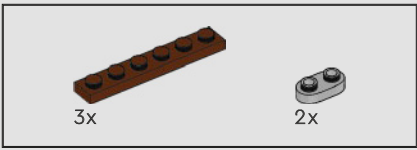

459

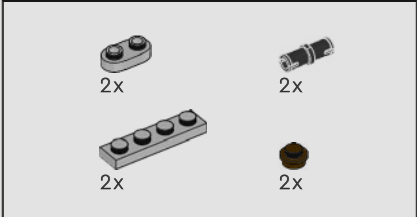
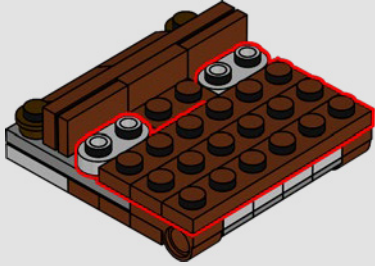

460

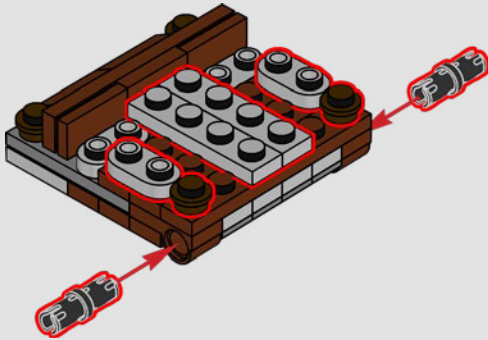

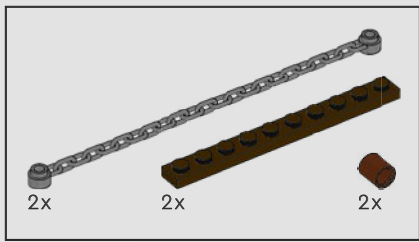

461

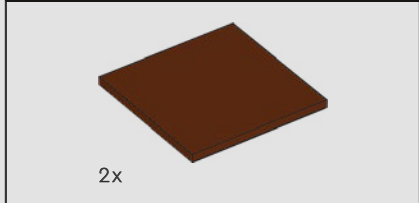
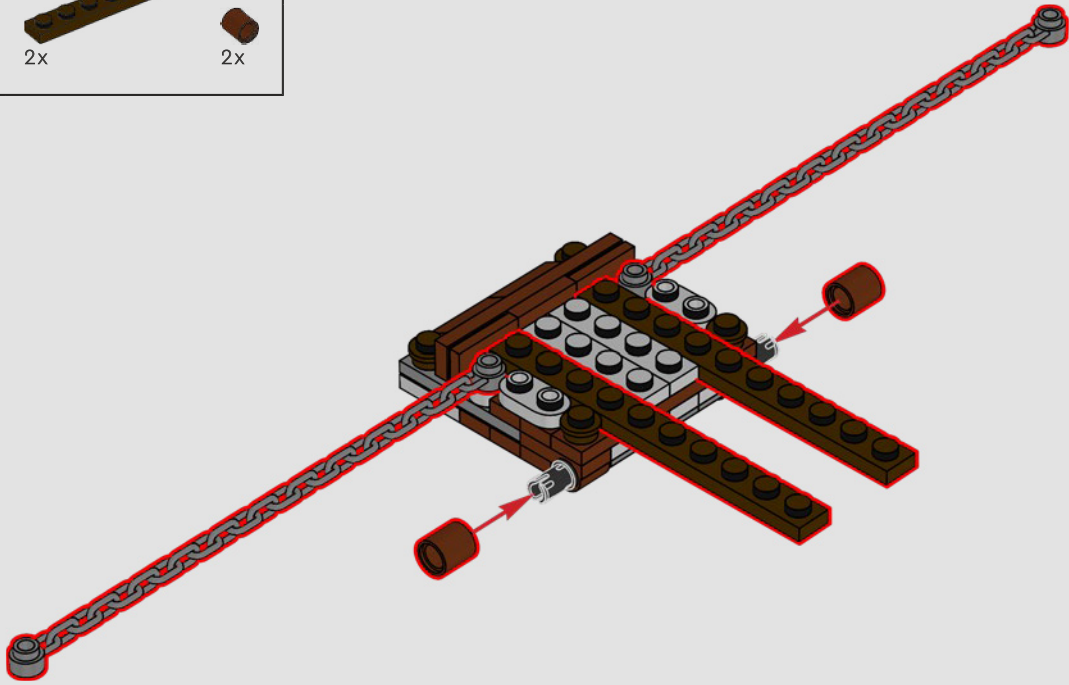

462

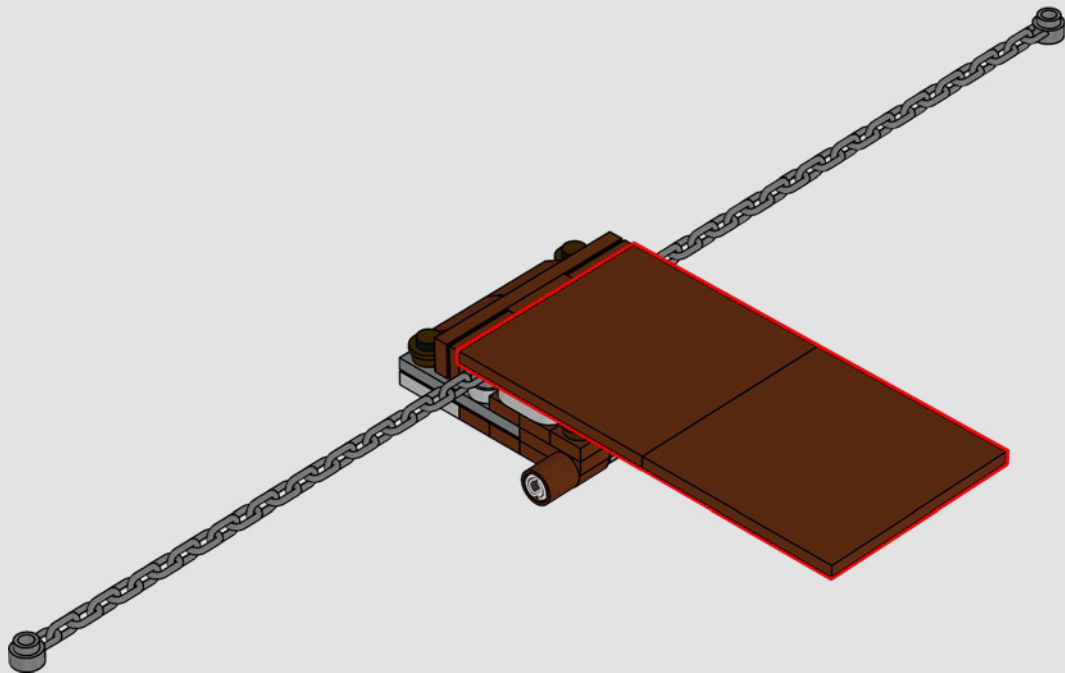

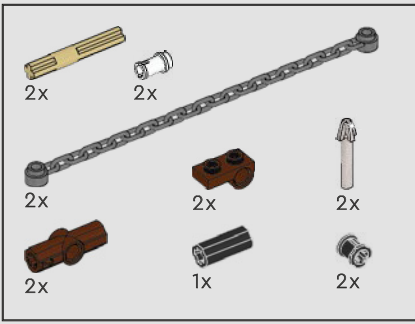

463

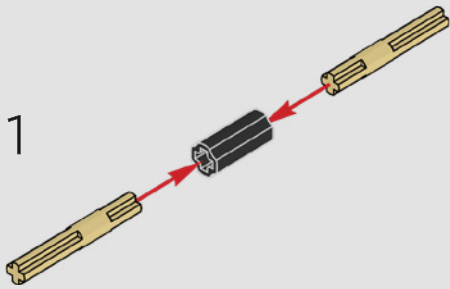

2

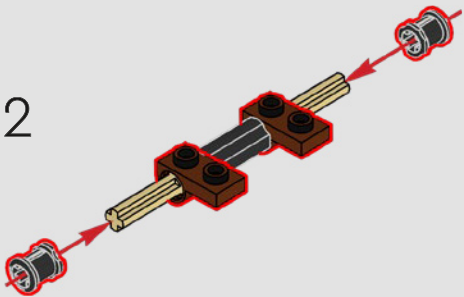

3

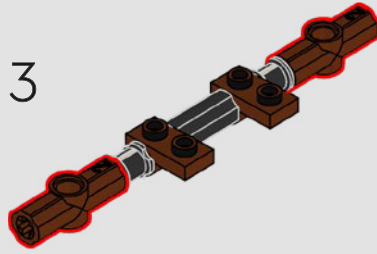

4

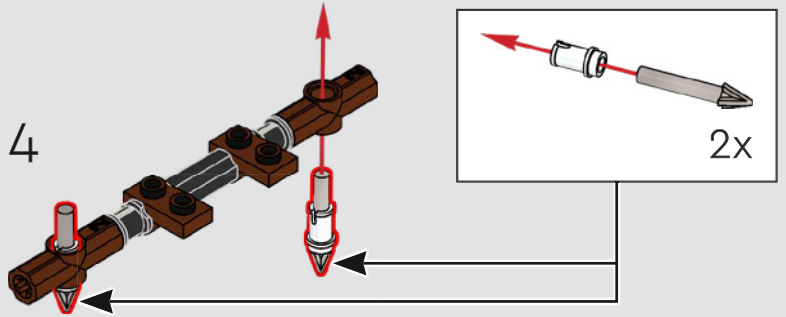

5

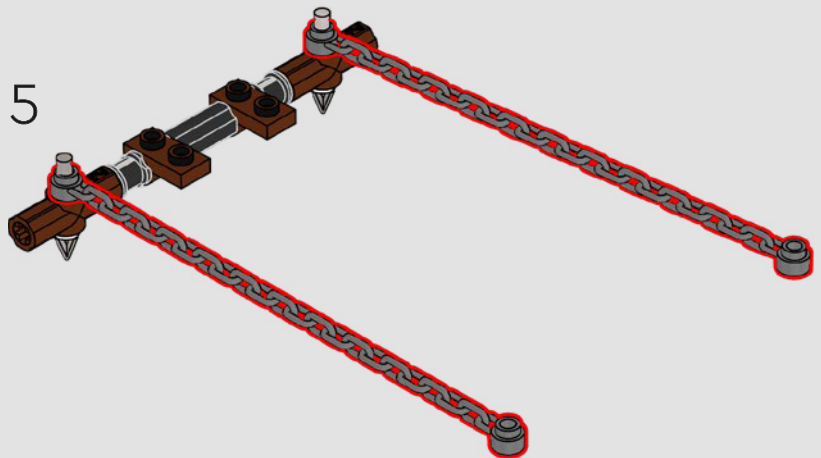

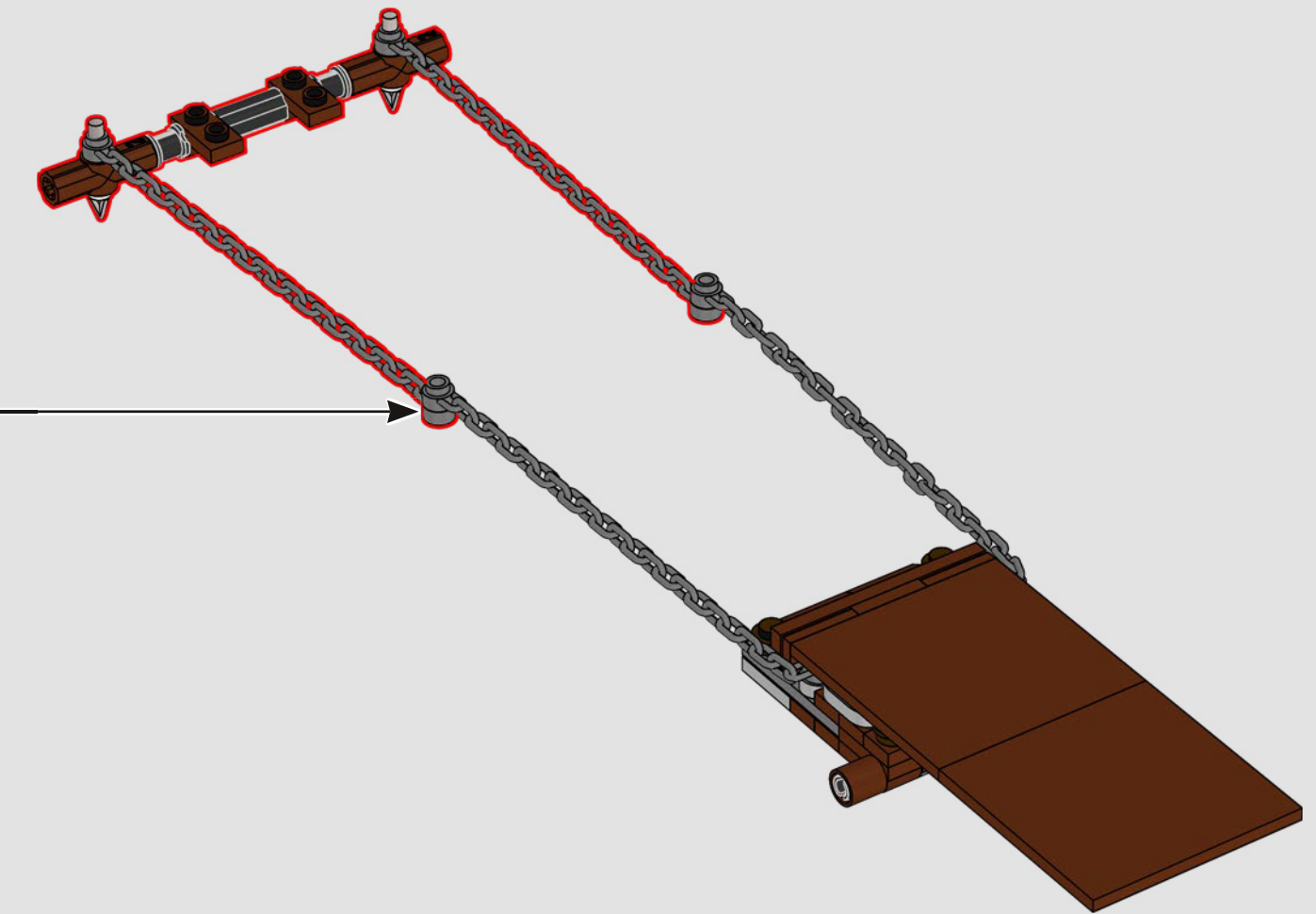

464

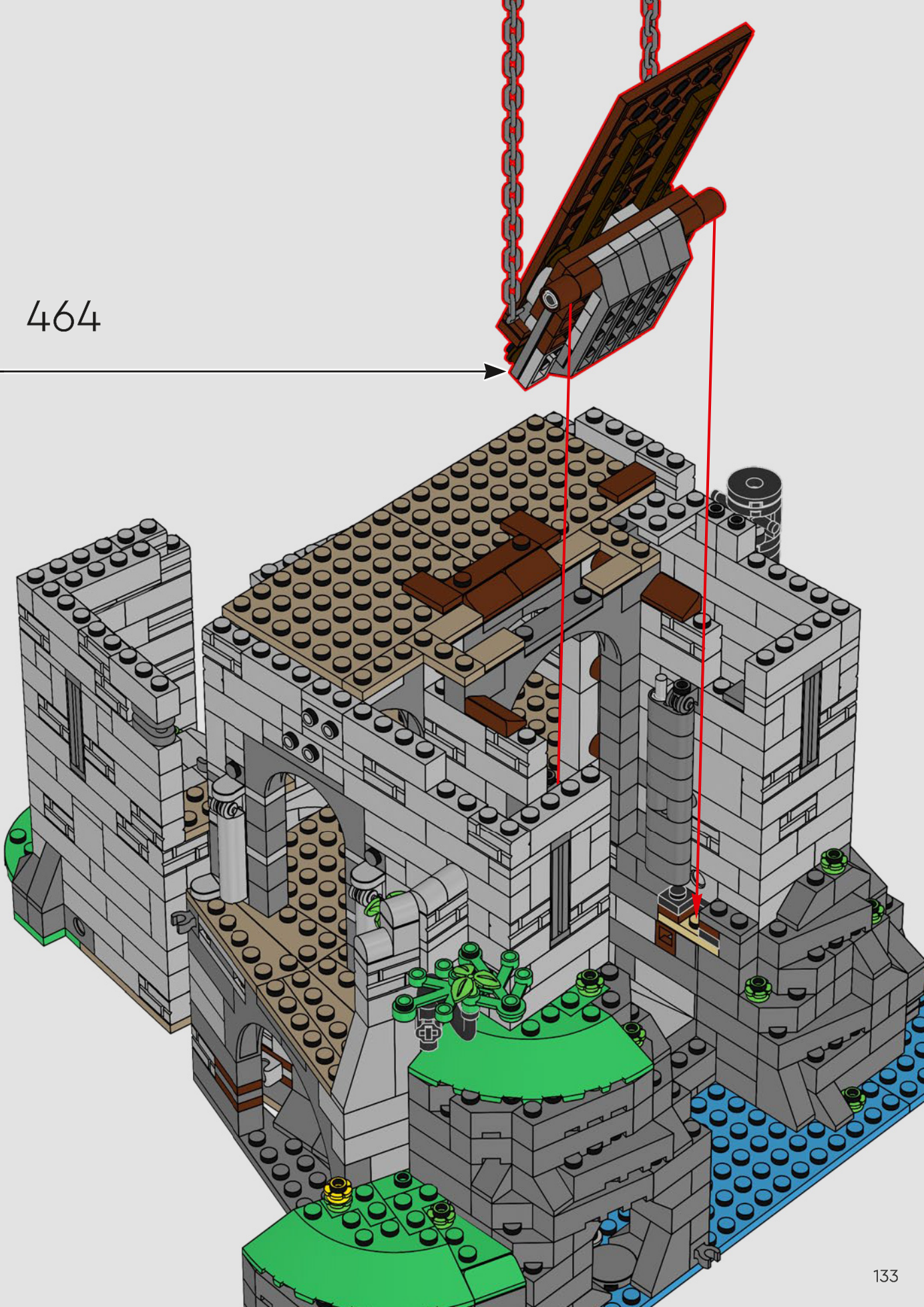

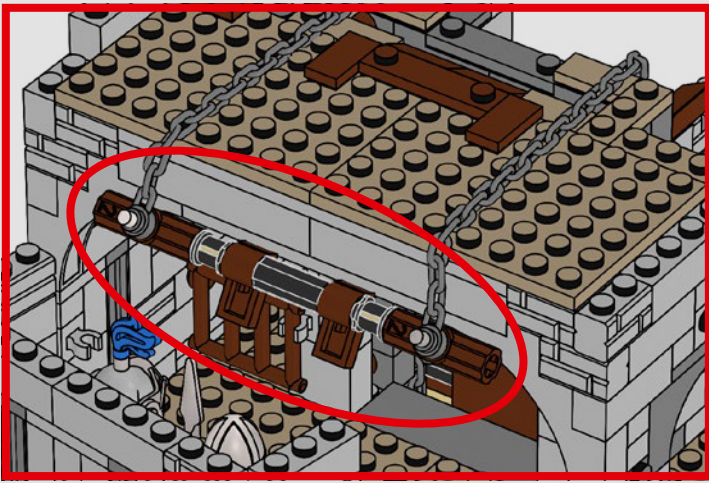

465





*Watch thyself on yon bridge lest ye
be cast into the dungeon!*

*Prenez garde sur ce pont si vous ne
voulez pas vous retrouver au cachot !*

*¡Ten cuidado en el puente para evitar
que te lancen al calabozo!*

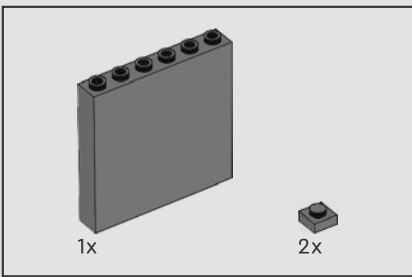

466

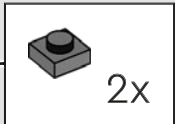

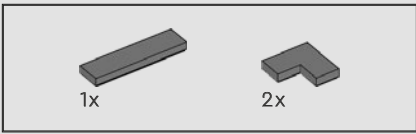

467



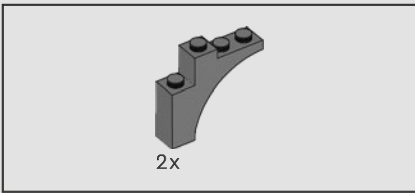

468

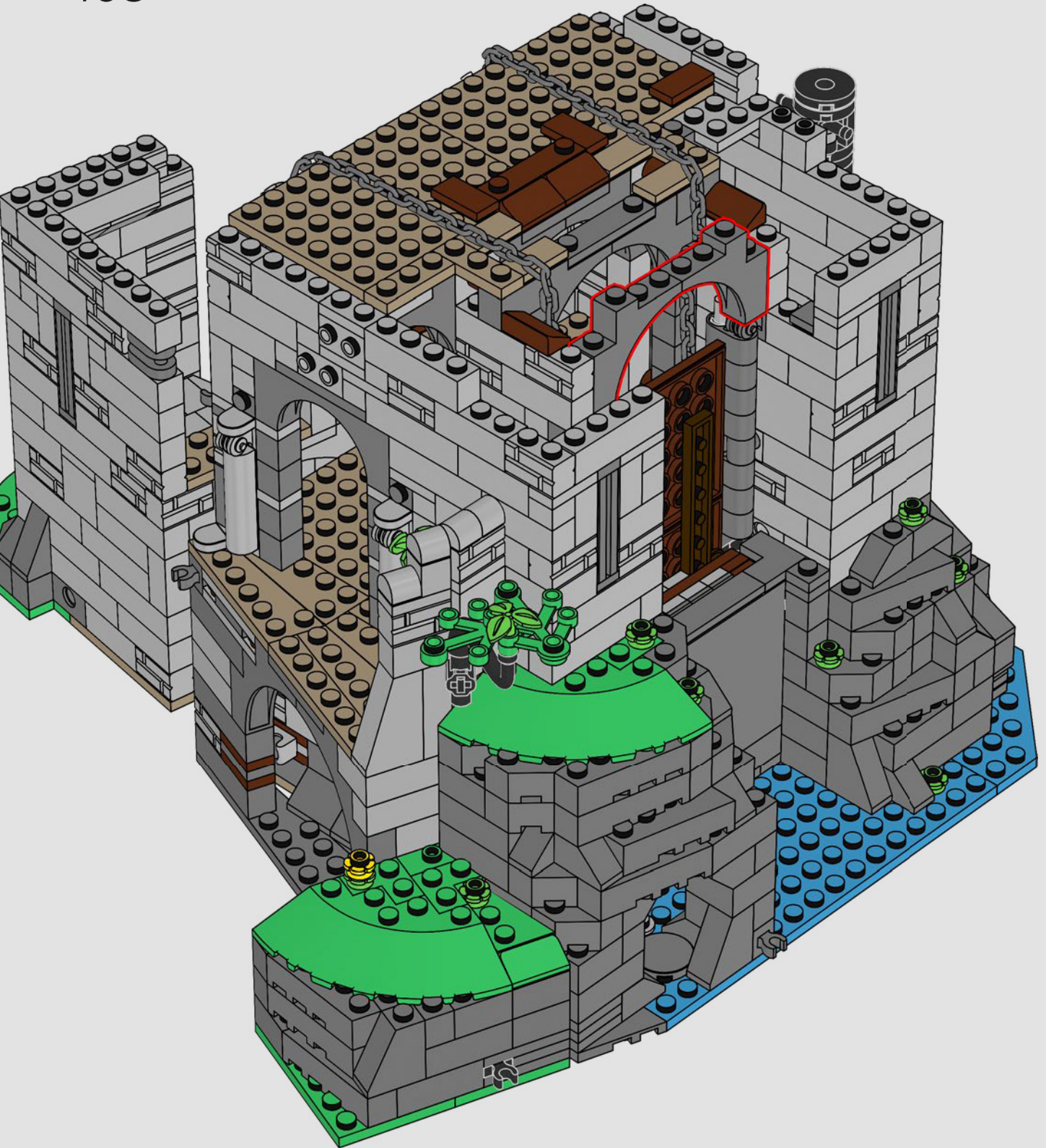

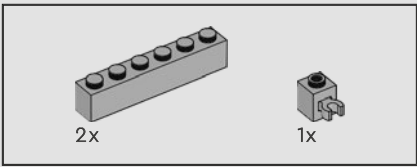

469

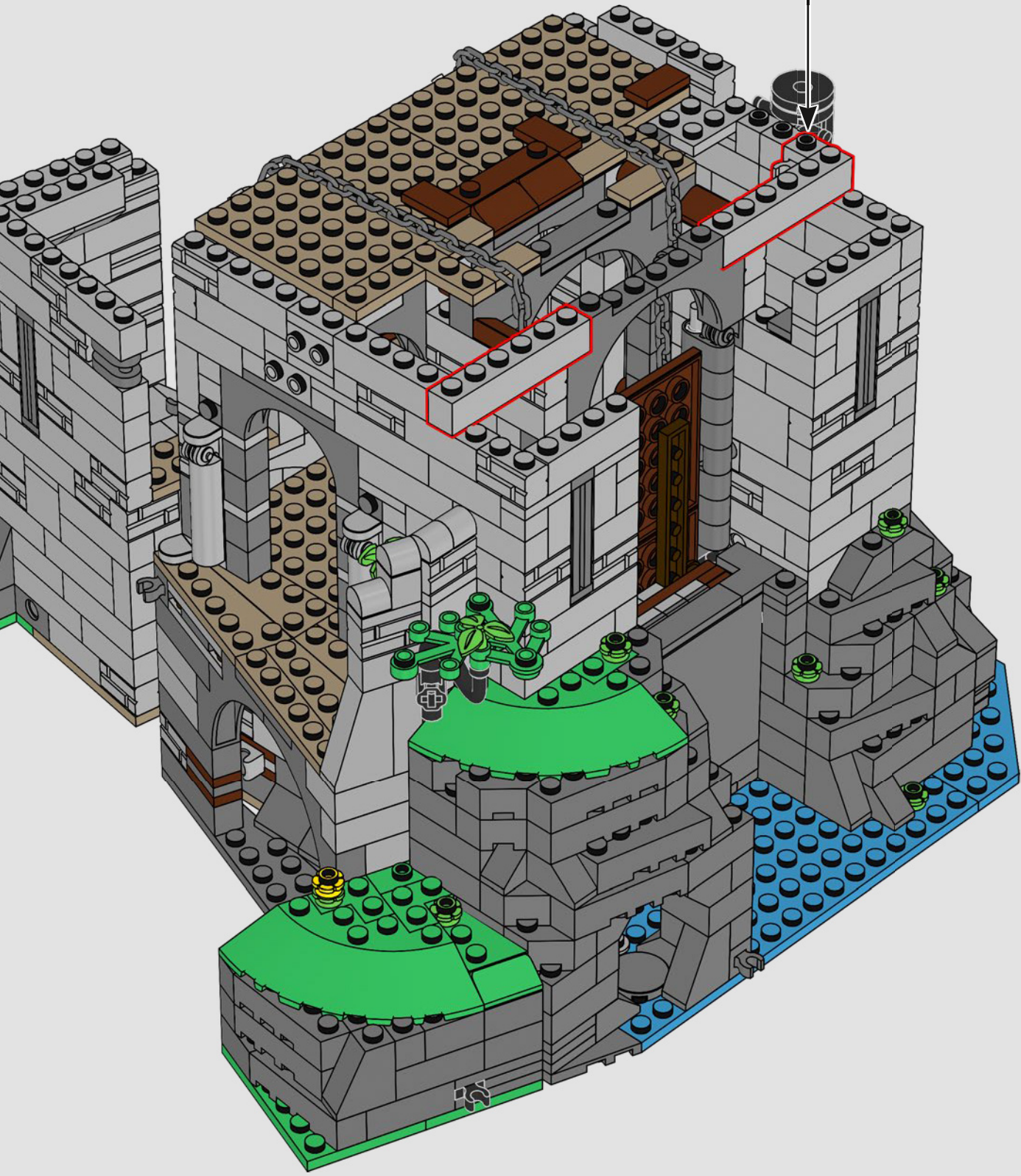
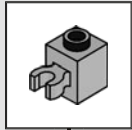

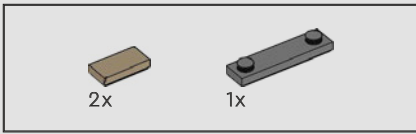

470

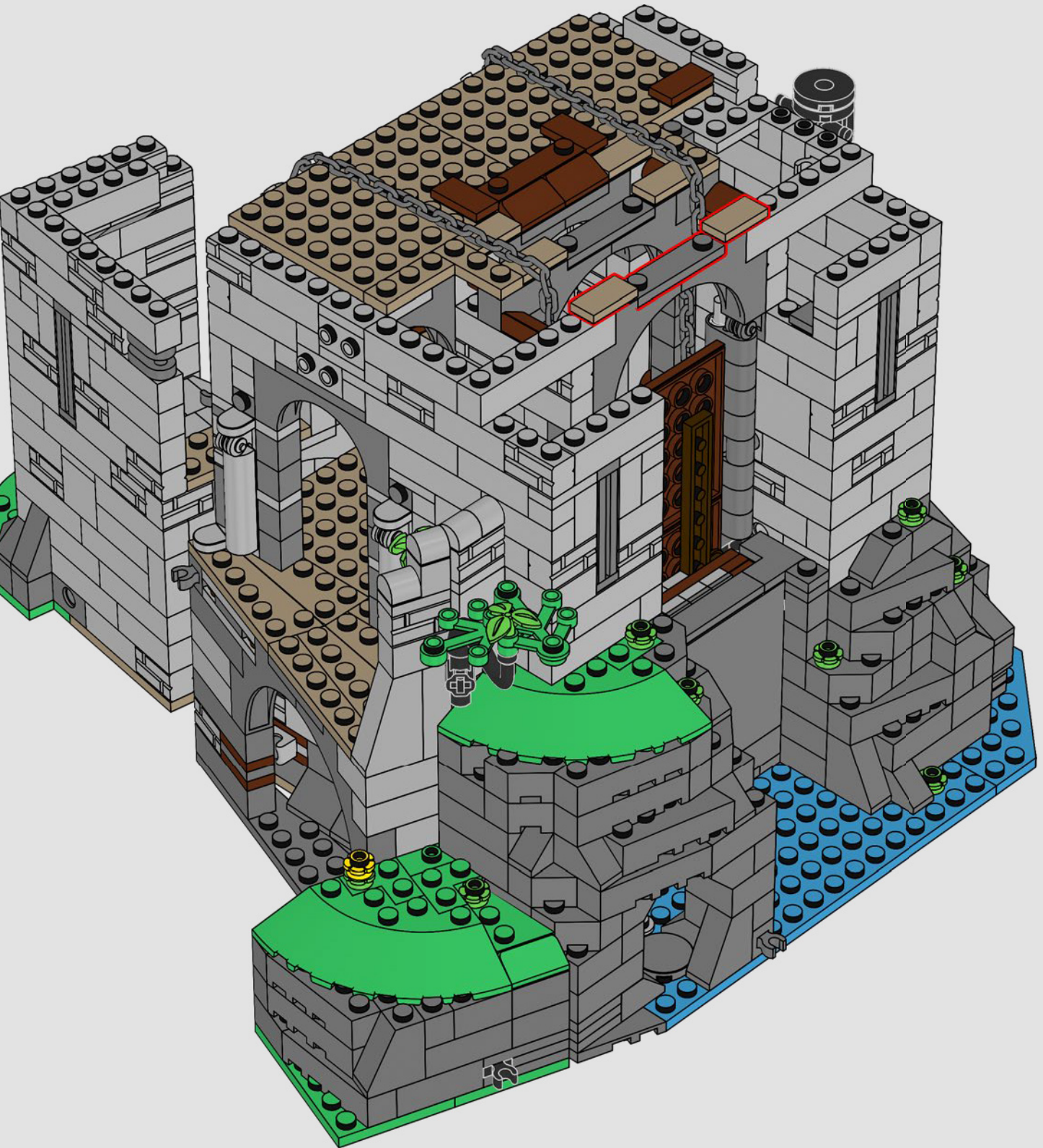

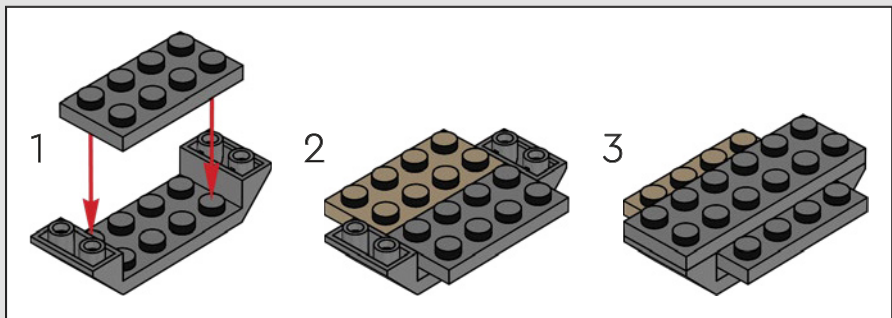
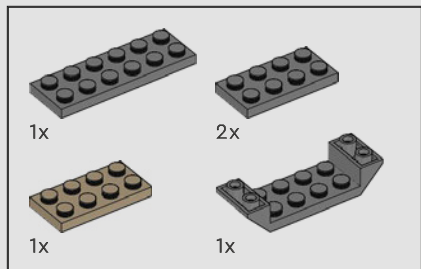

471

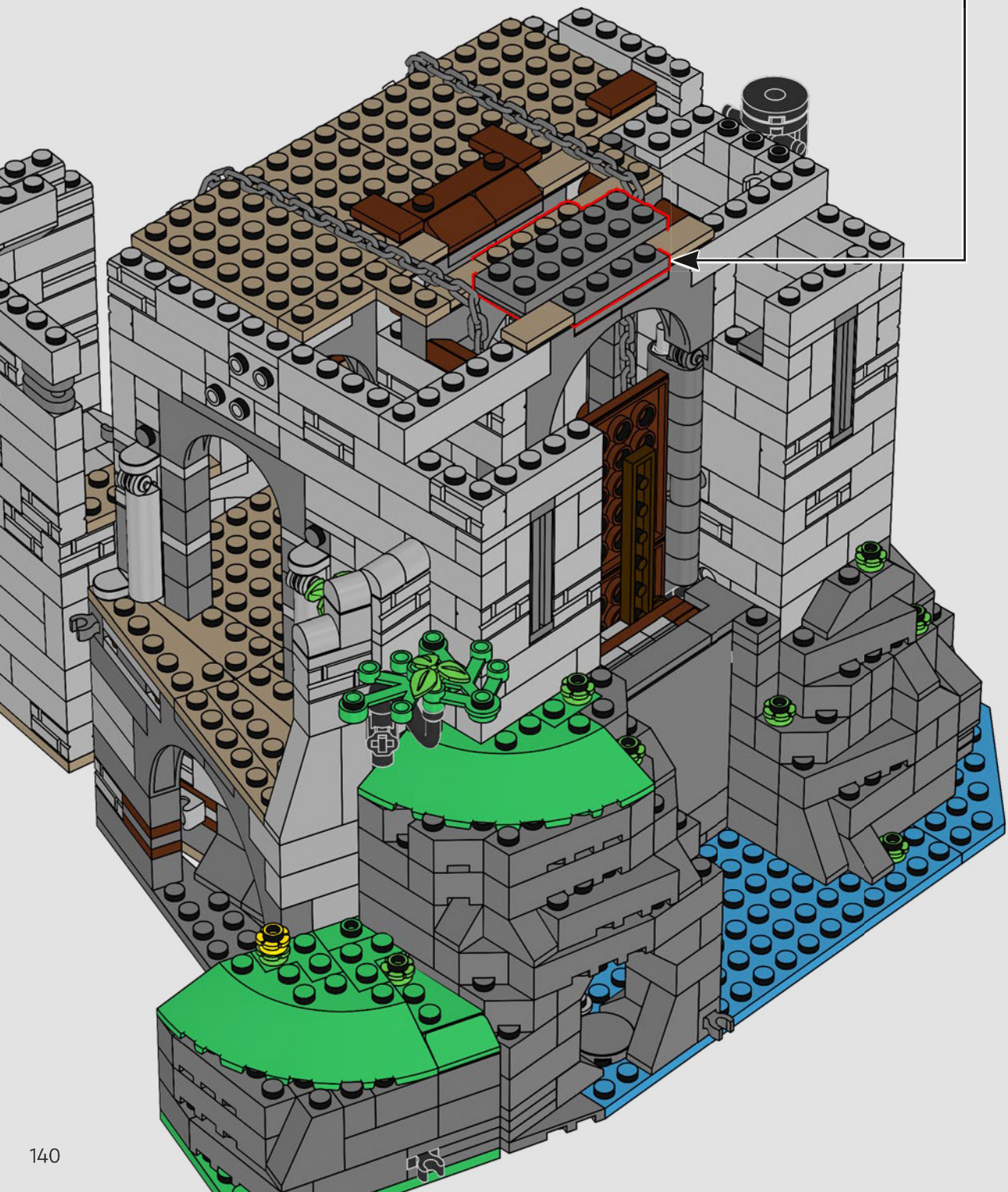

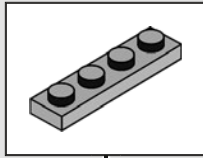
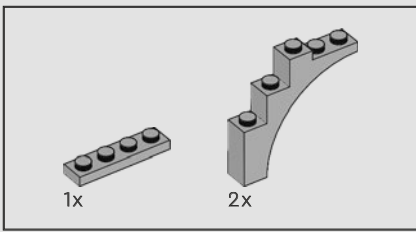

472

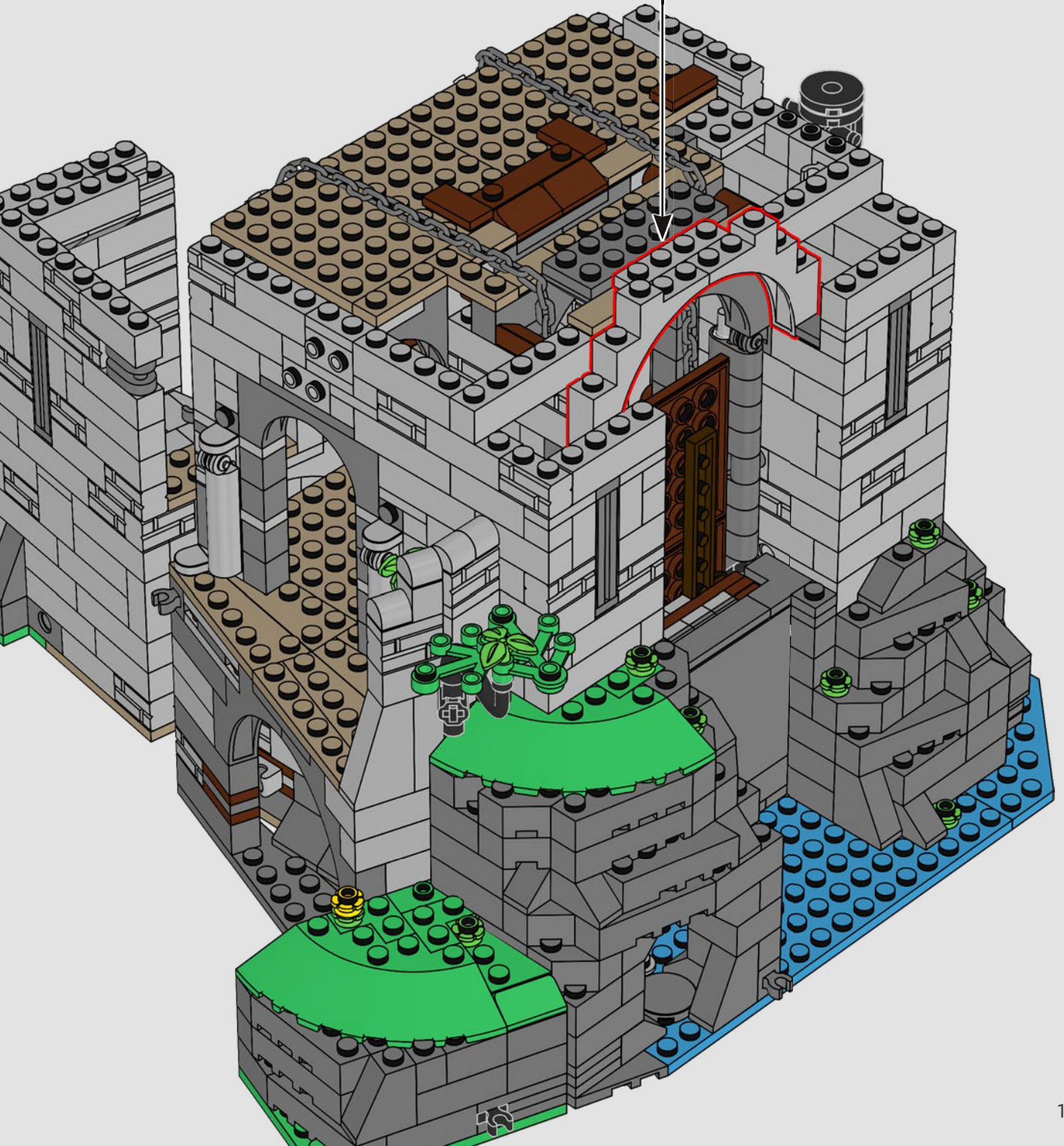

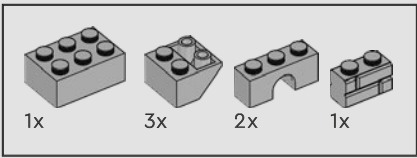

473

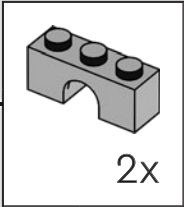
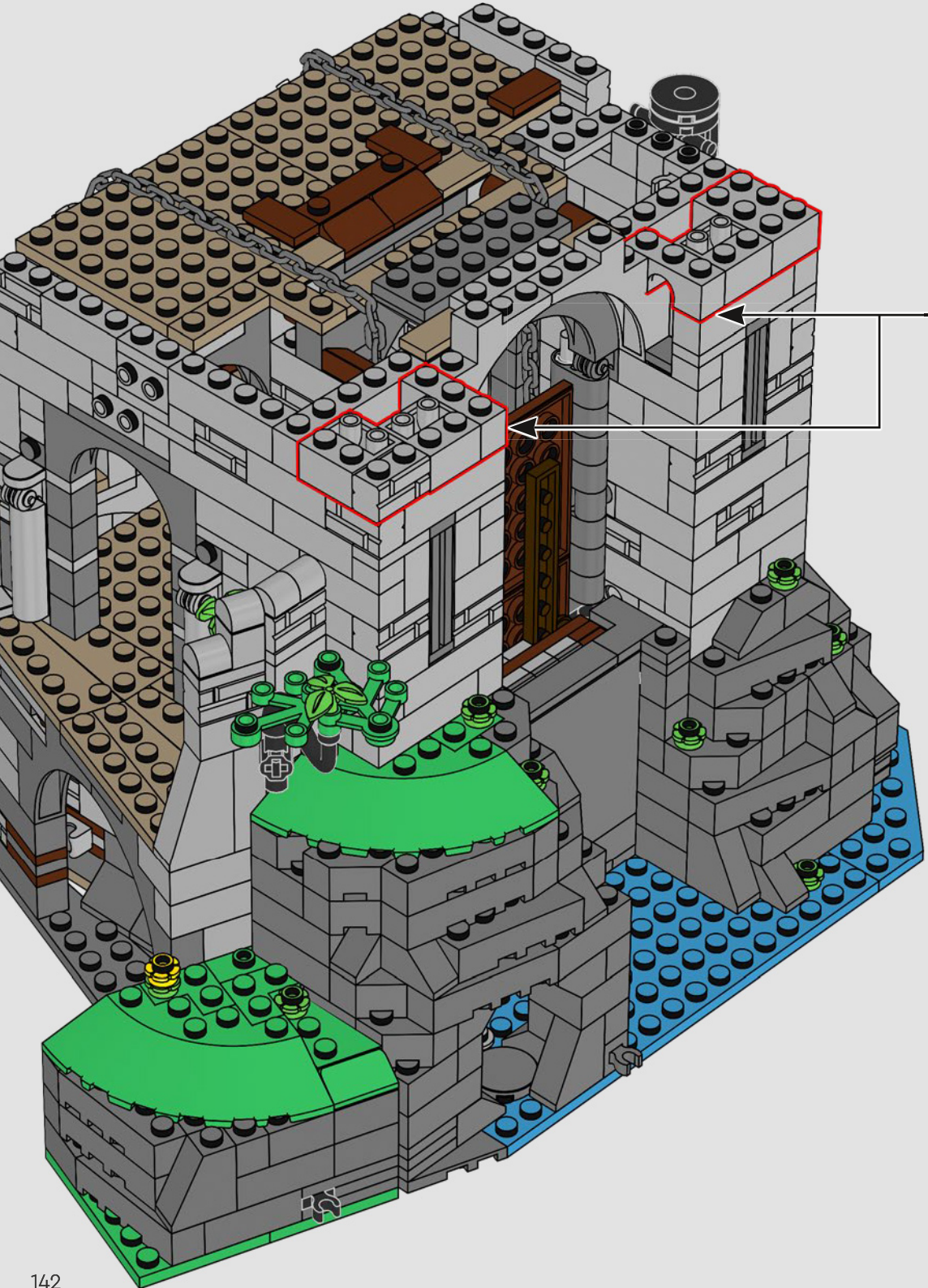

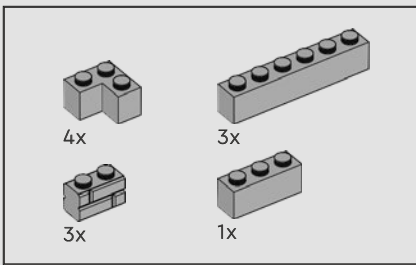

474

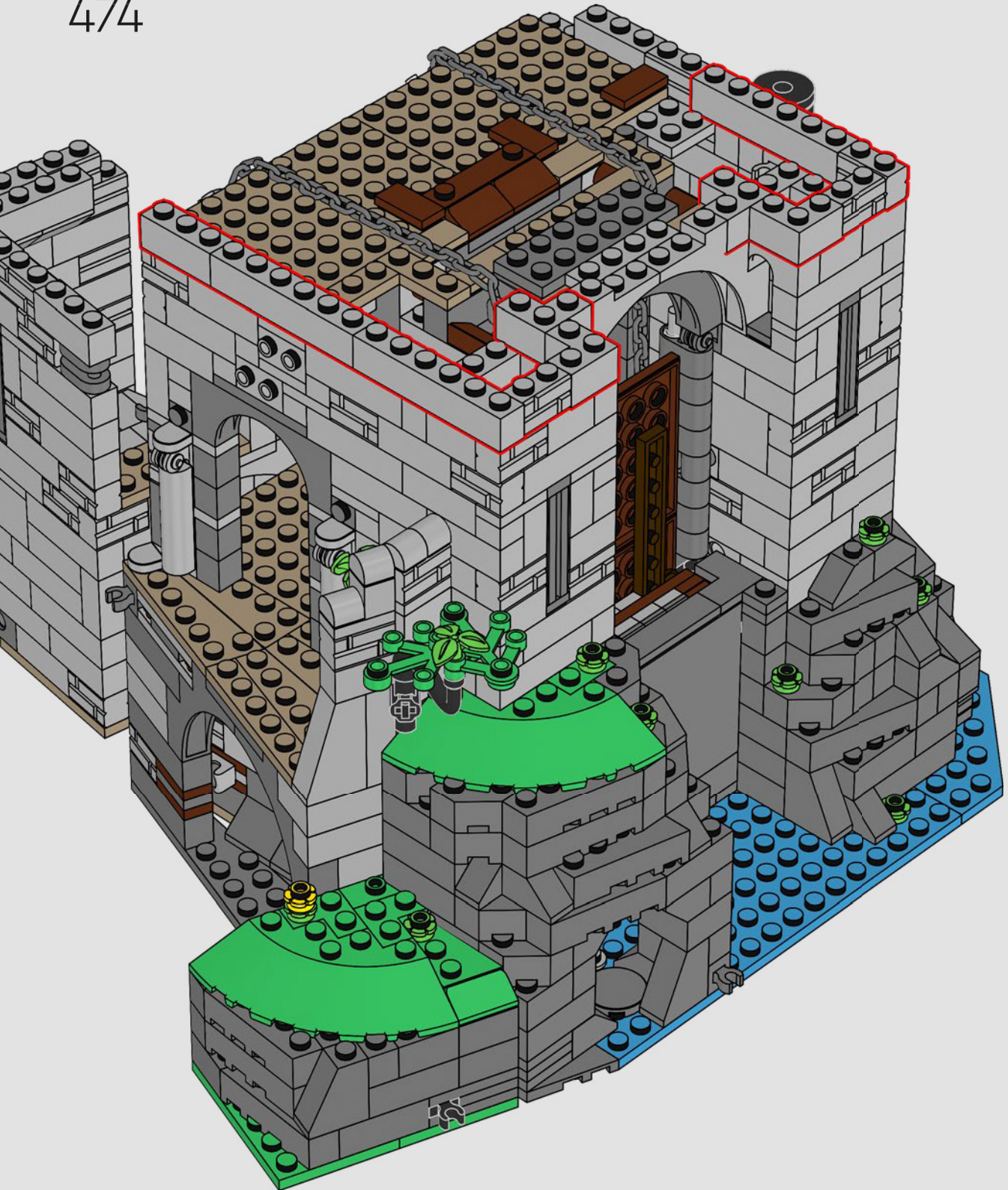

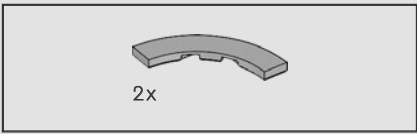

475

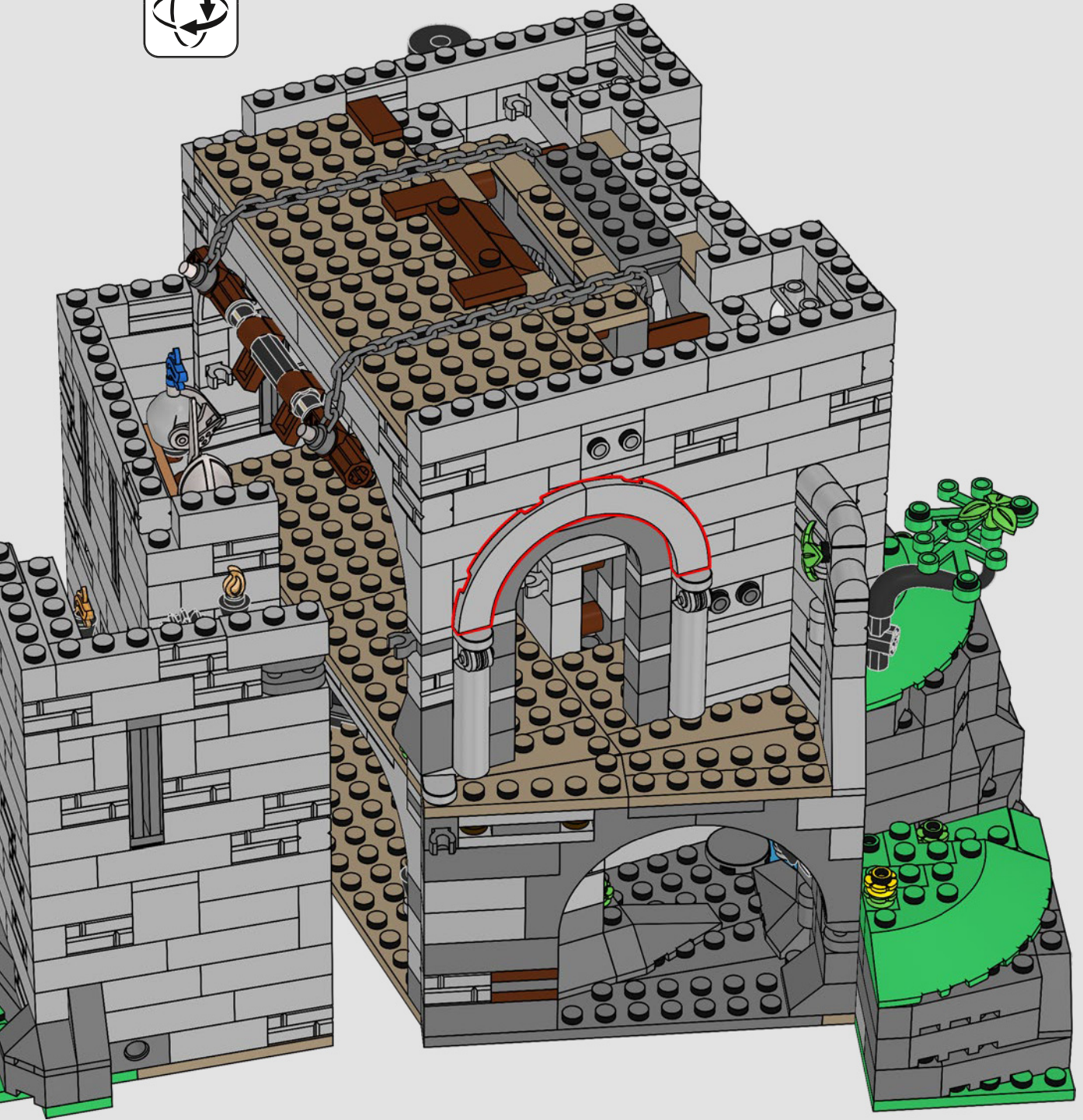

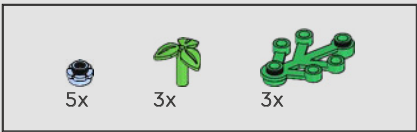

476

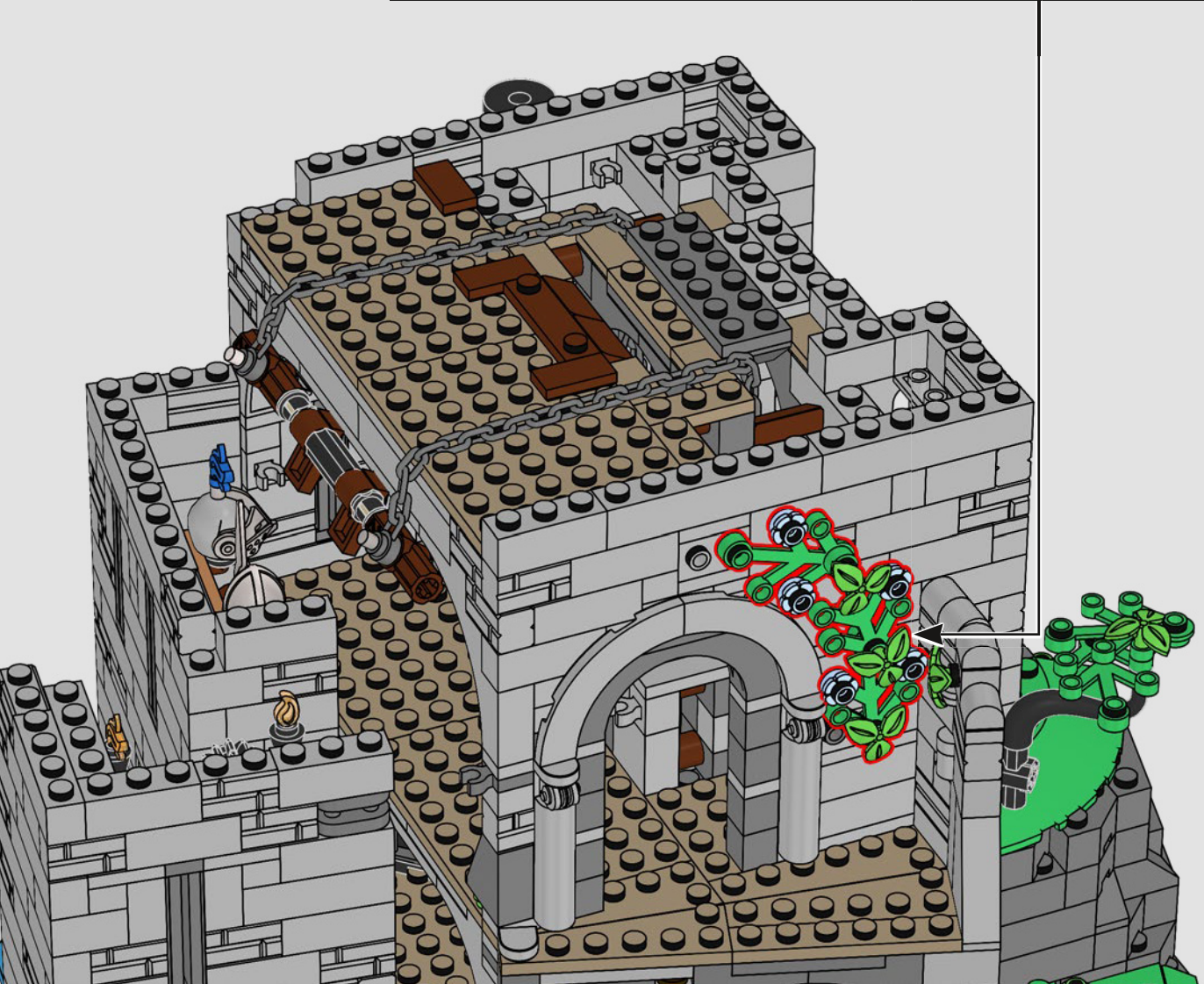
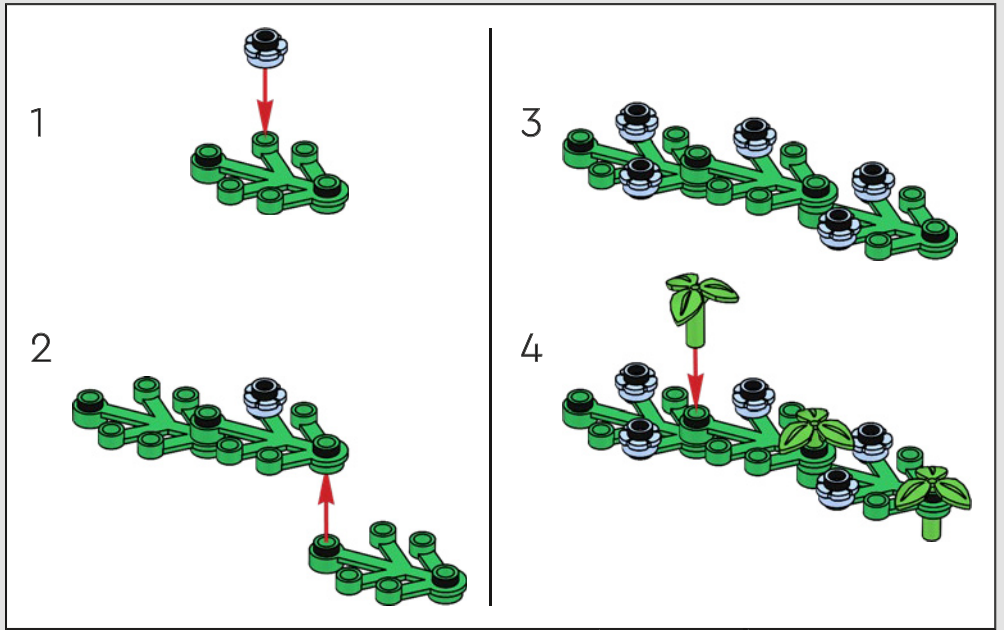

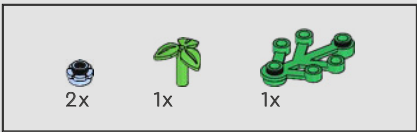

477

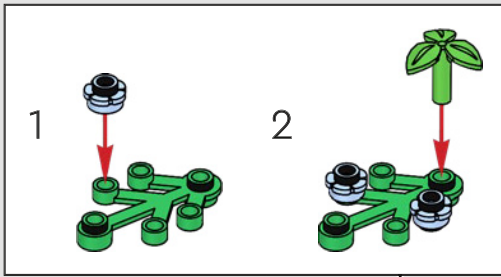

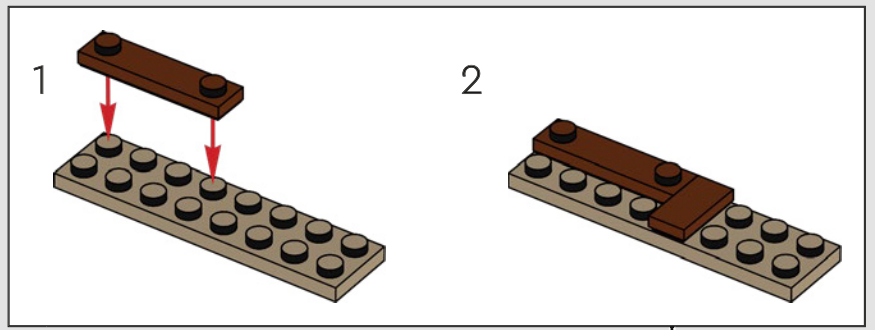
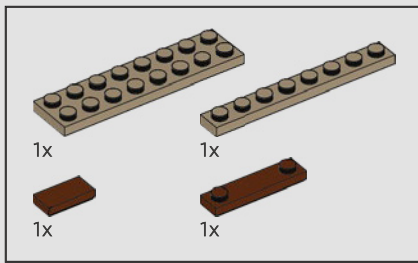

478



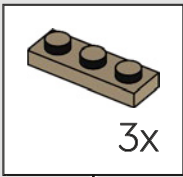
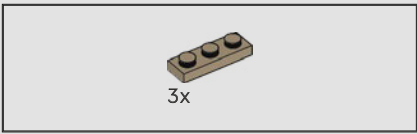

479

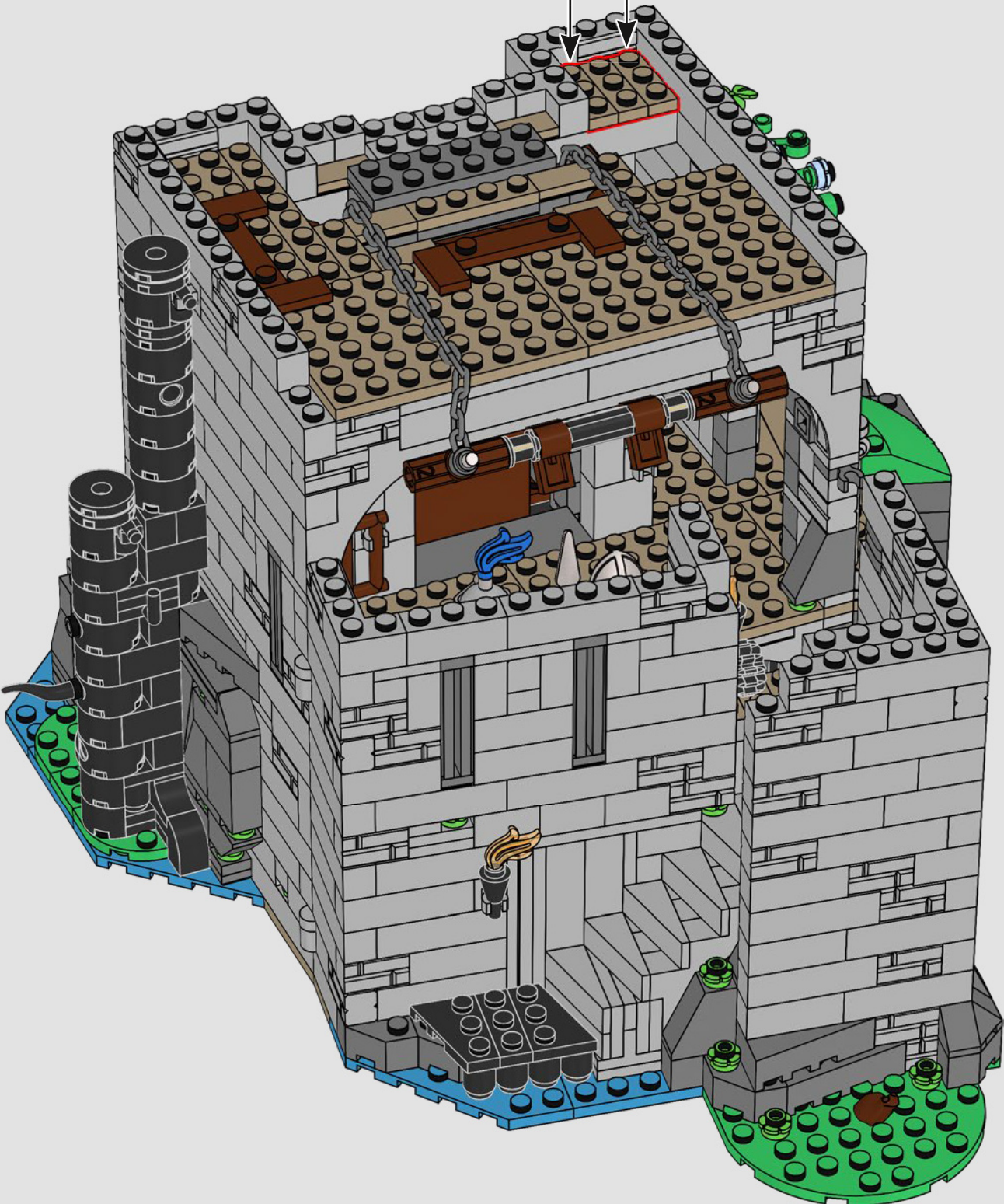

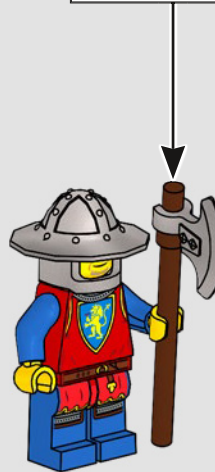
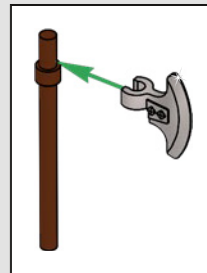
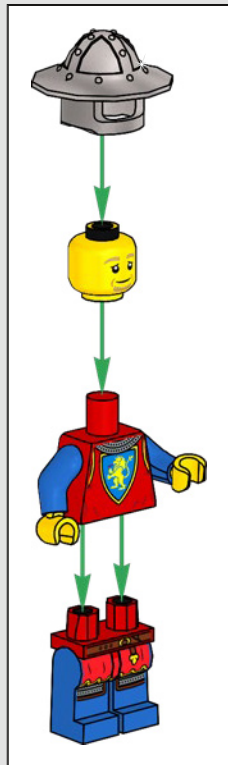

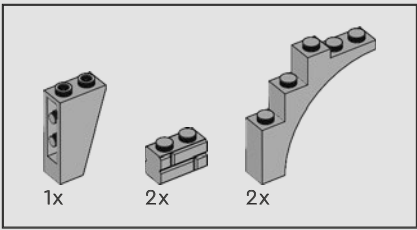

480

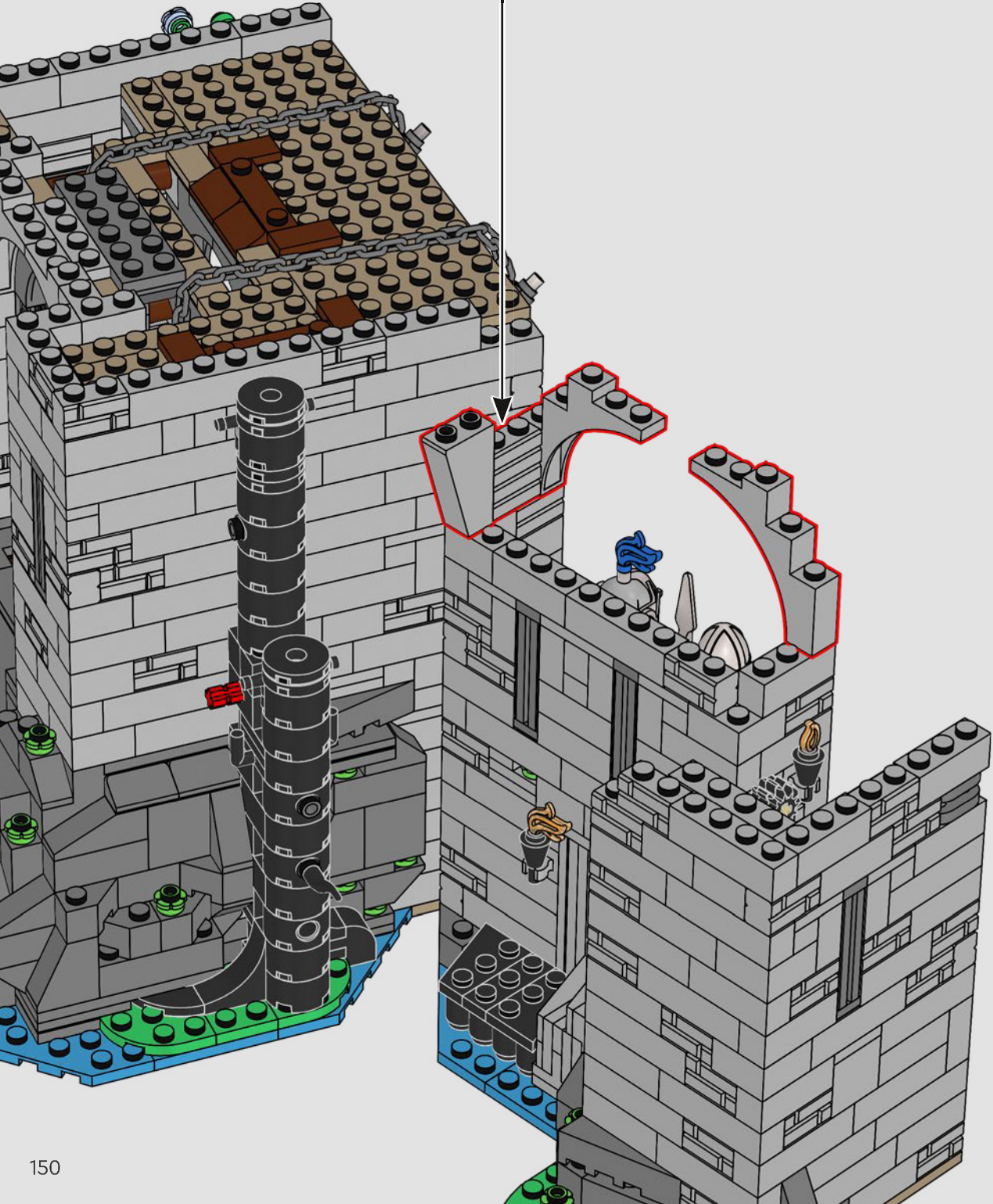
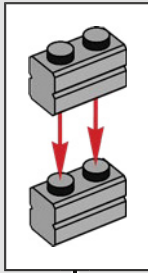

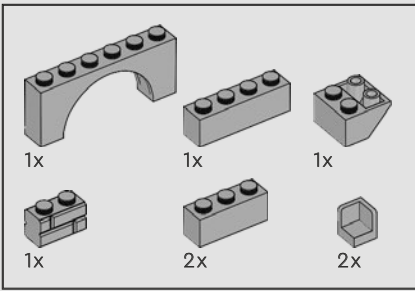

481

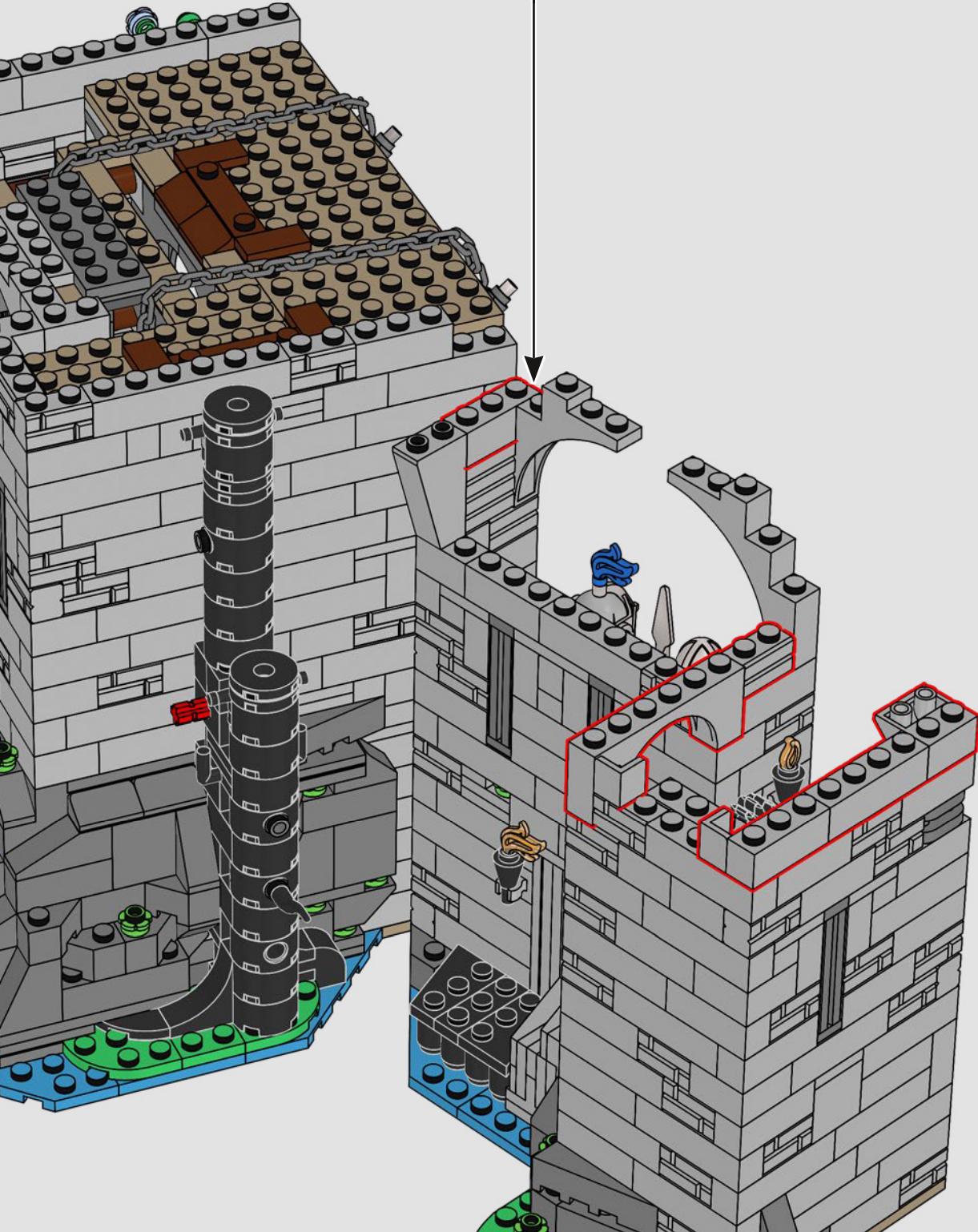
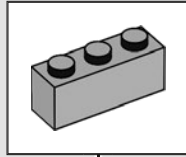

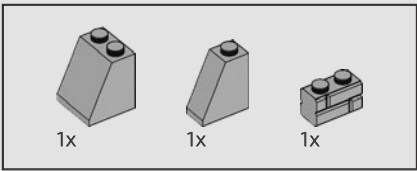

482

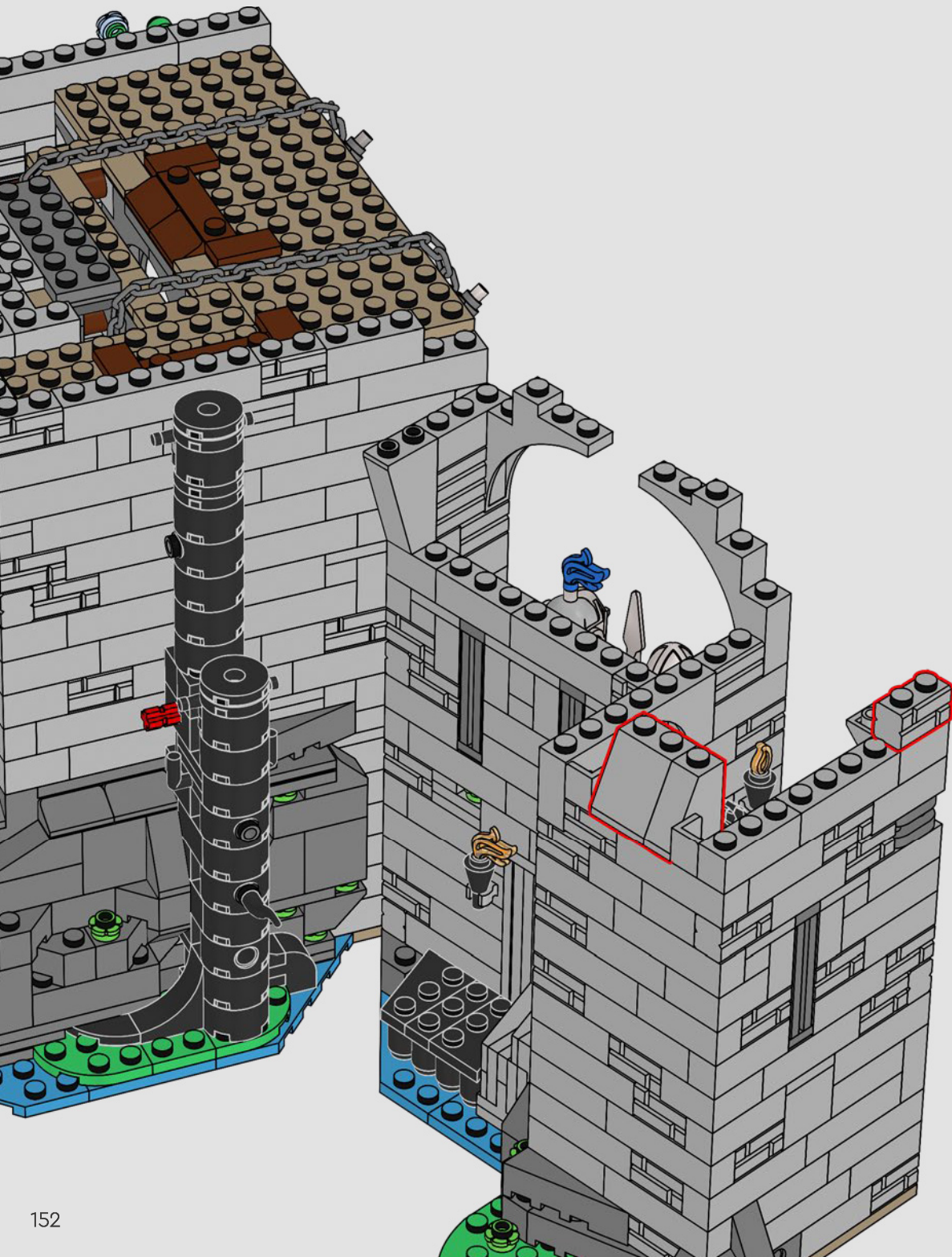

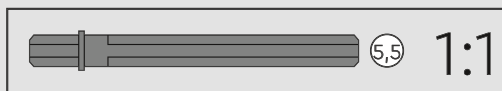
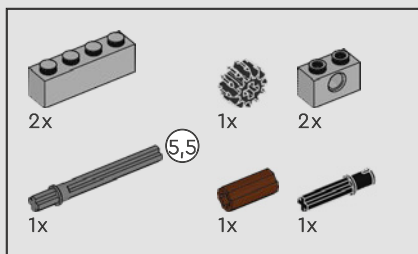

483

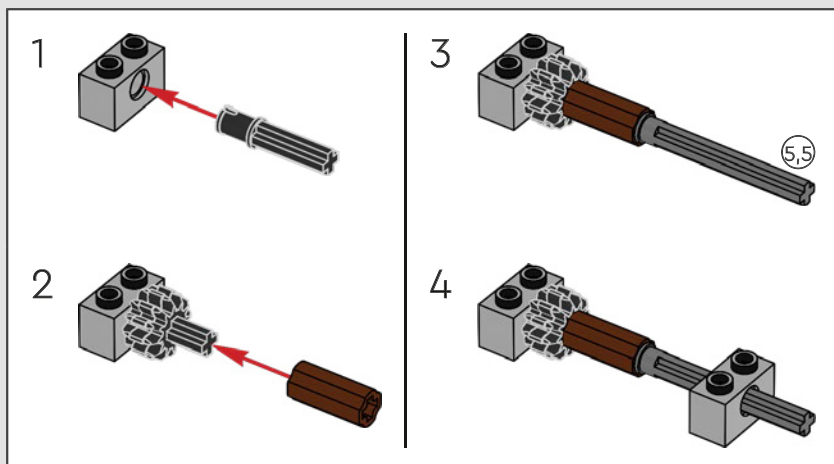



484

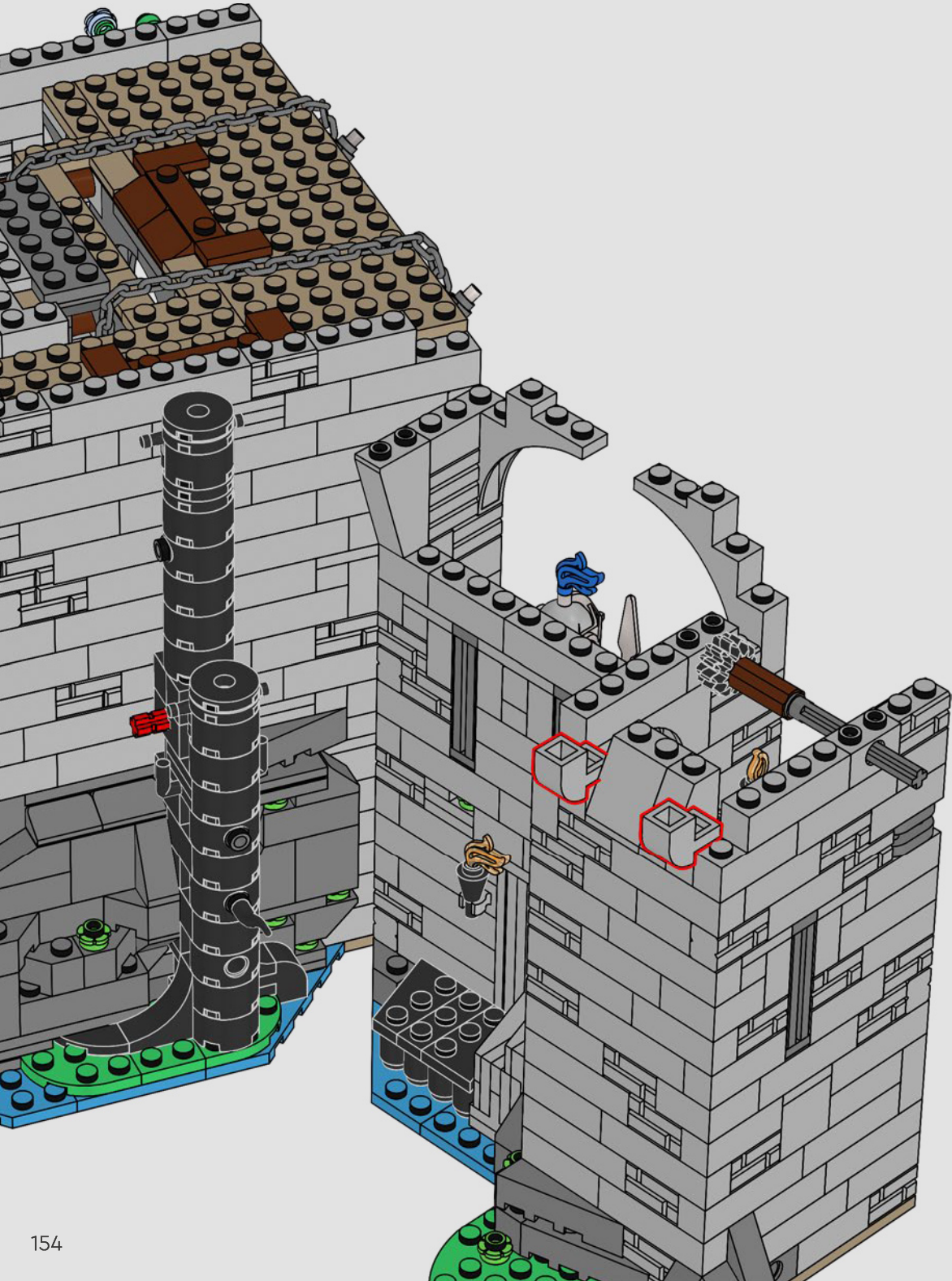

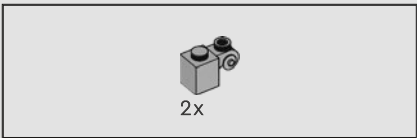

485

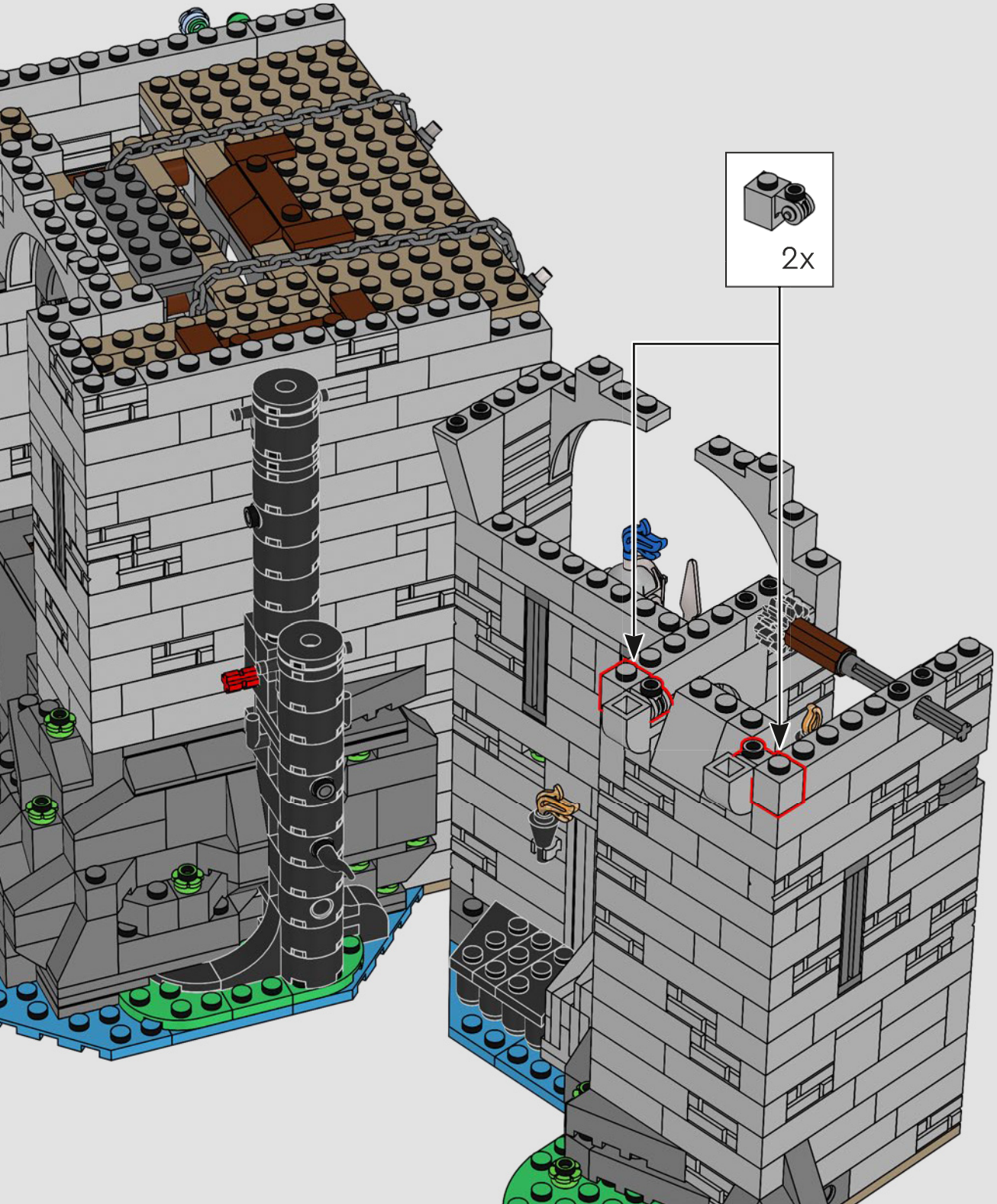

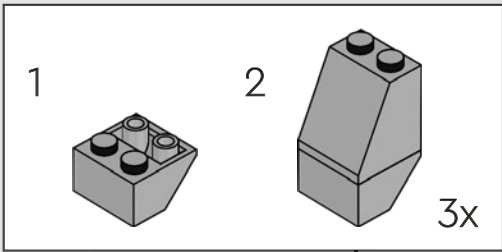
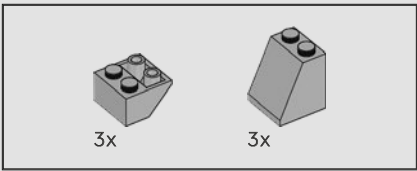

486

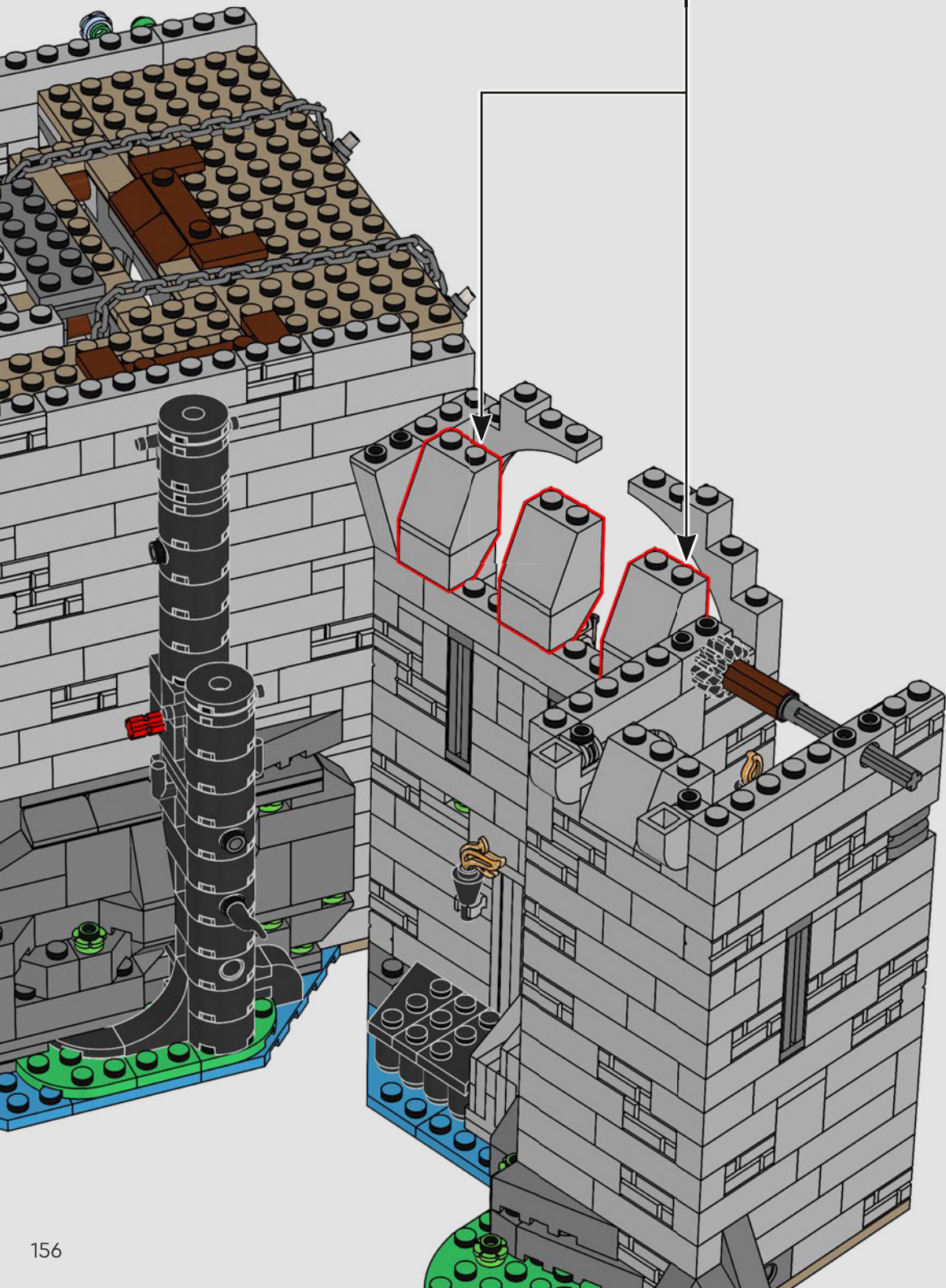

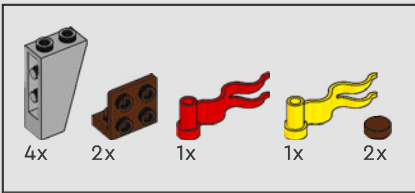

487

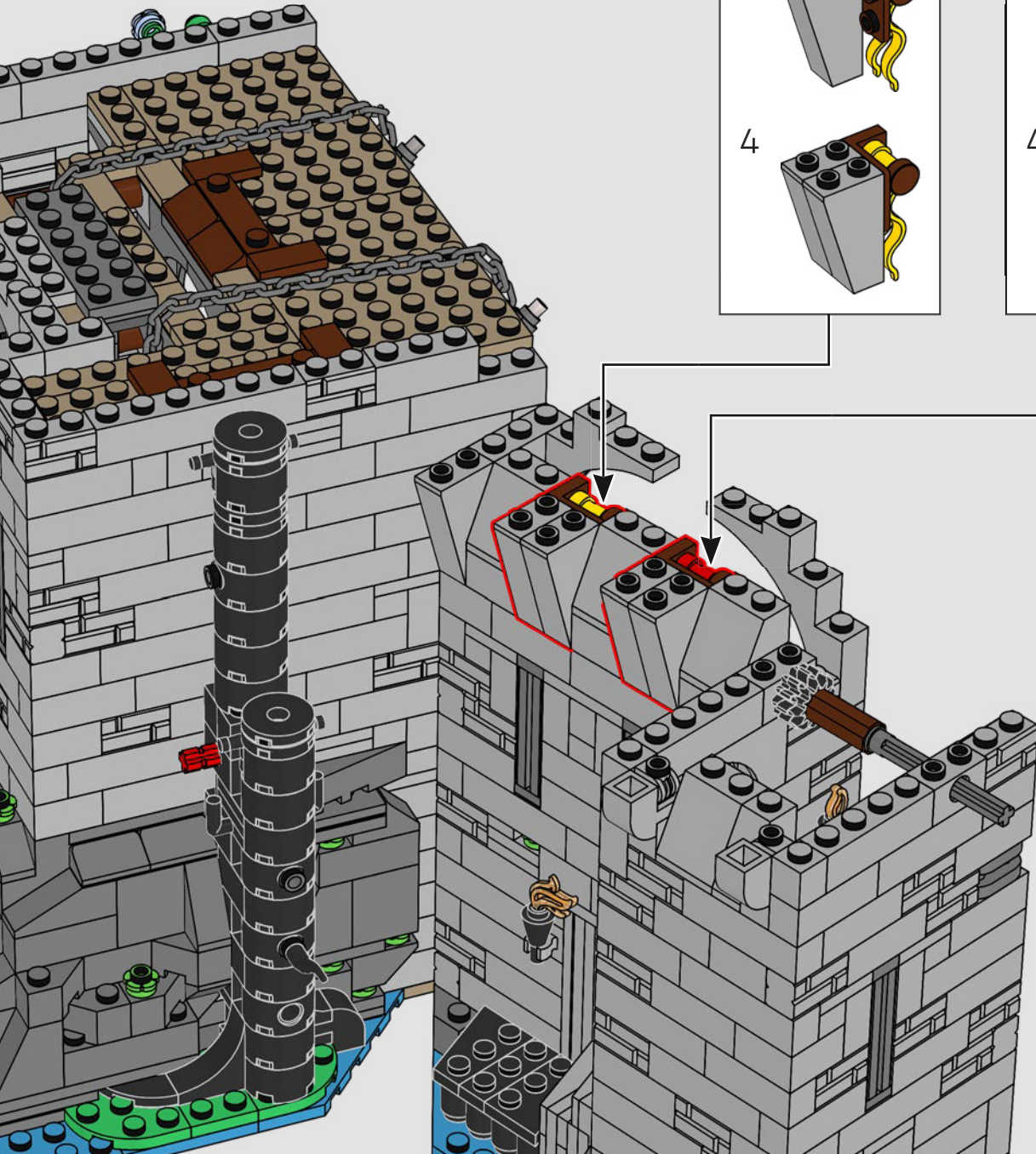
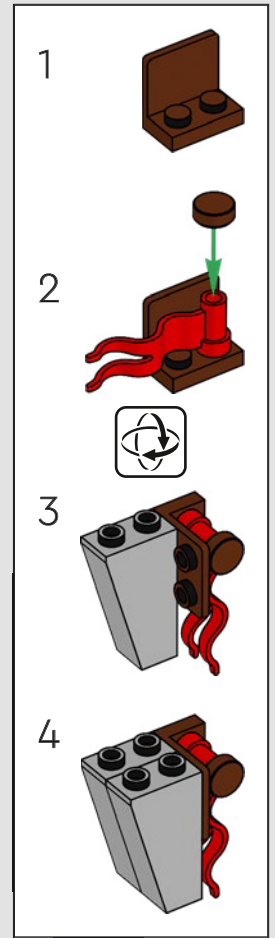
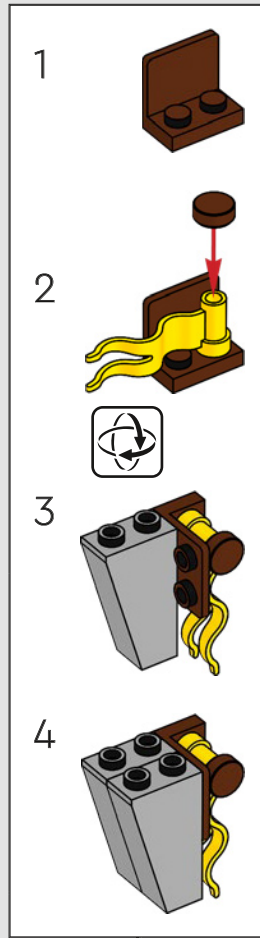

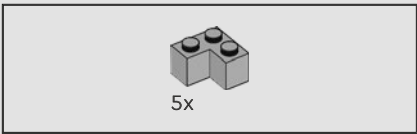

488

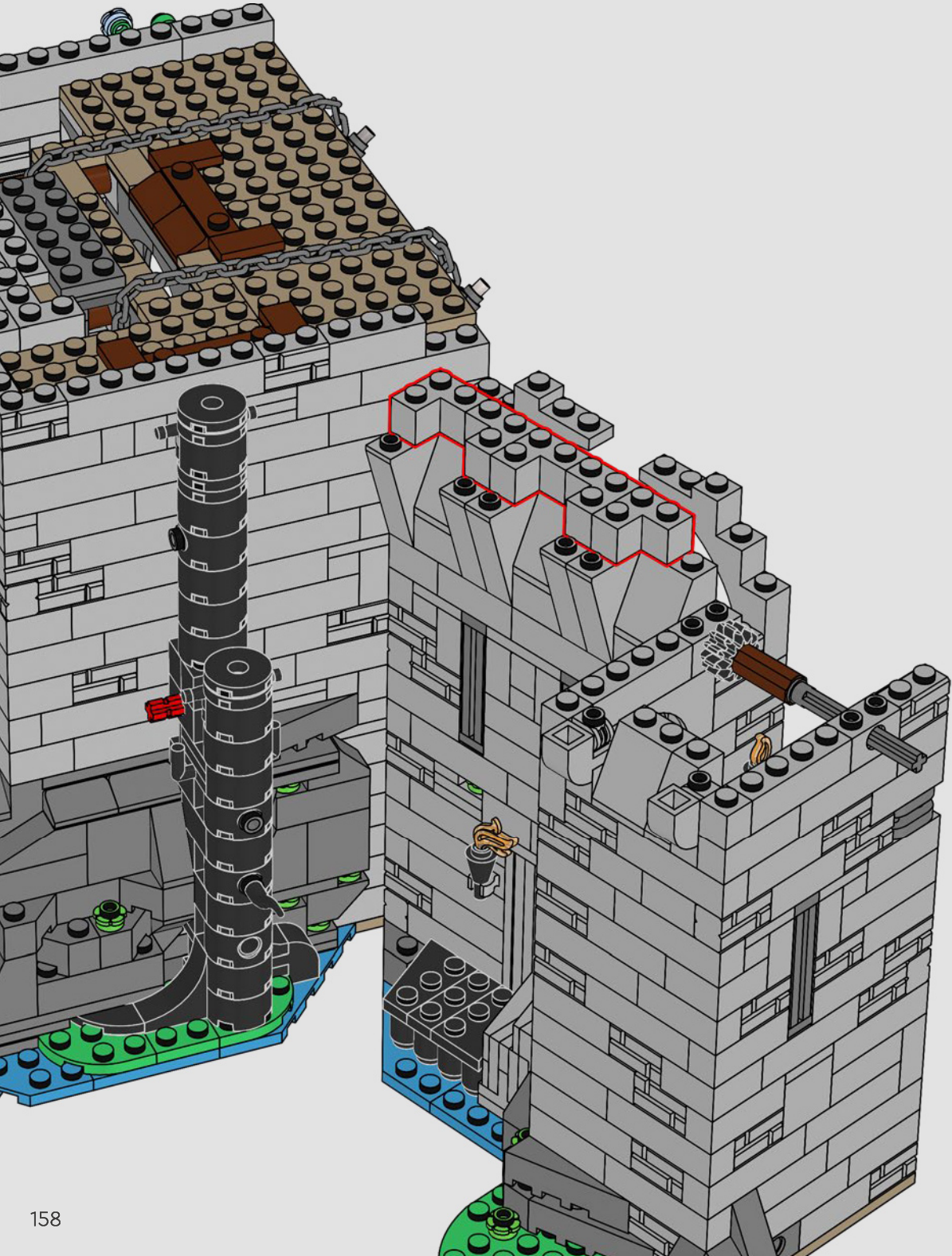

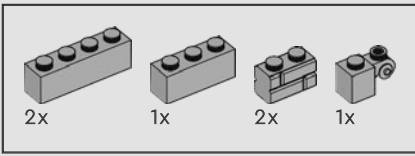

489

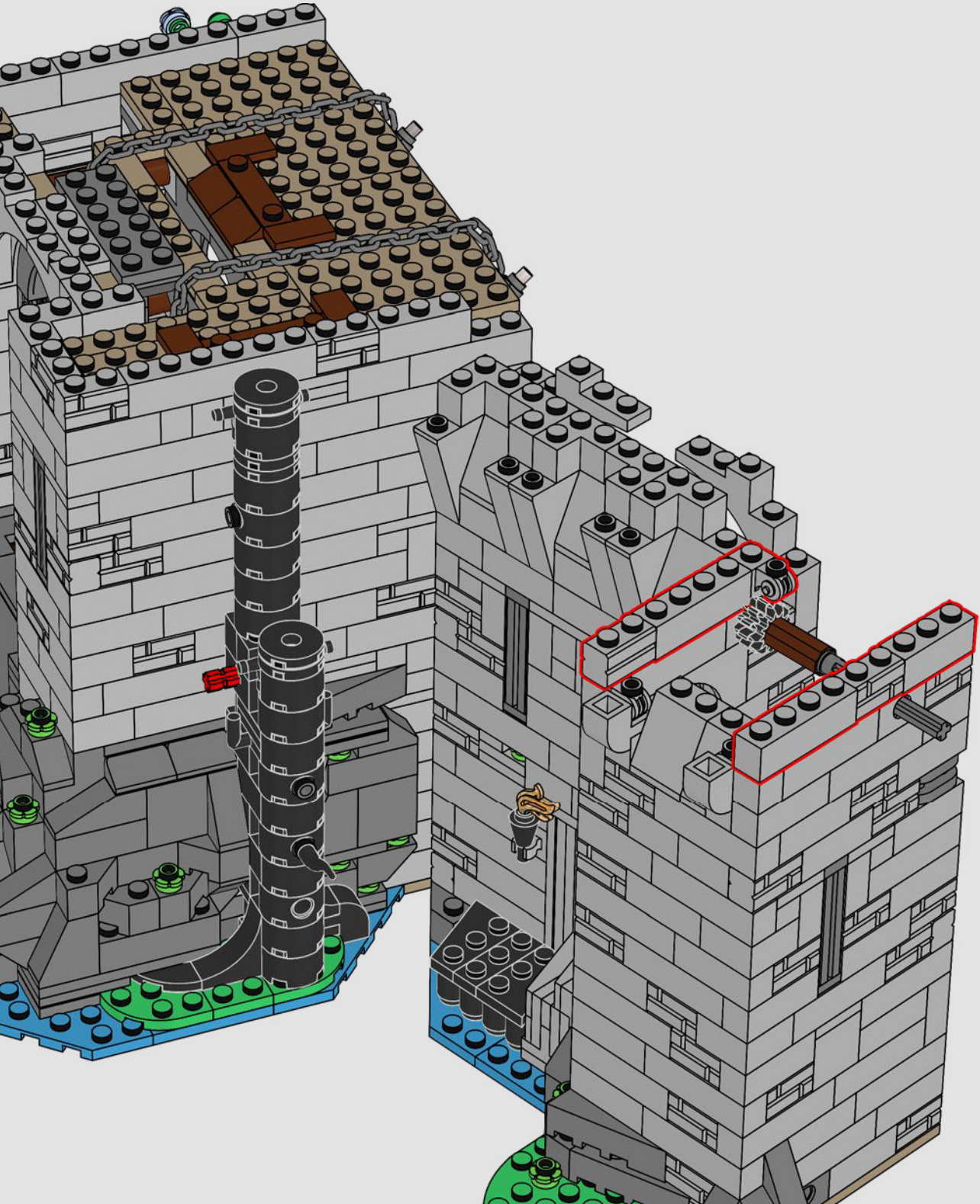

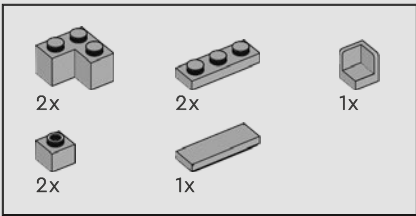

490

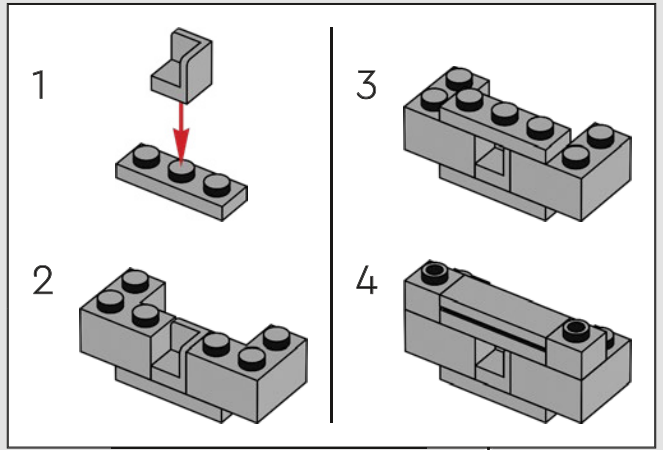

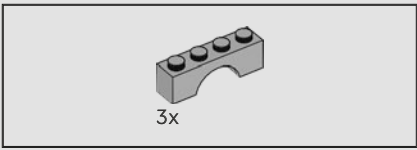

491

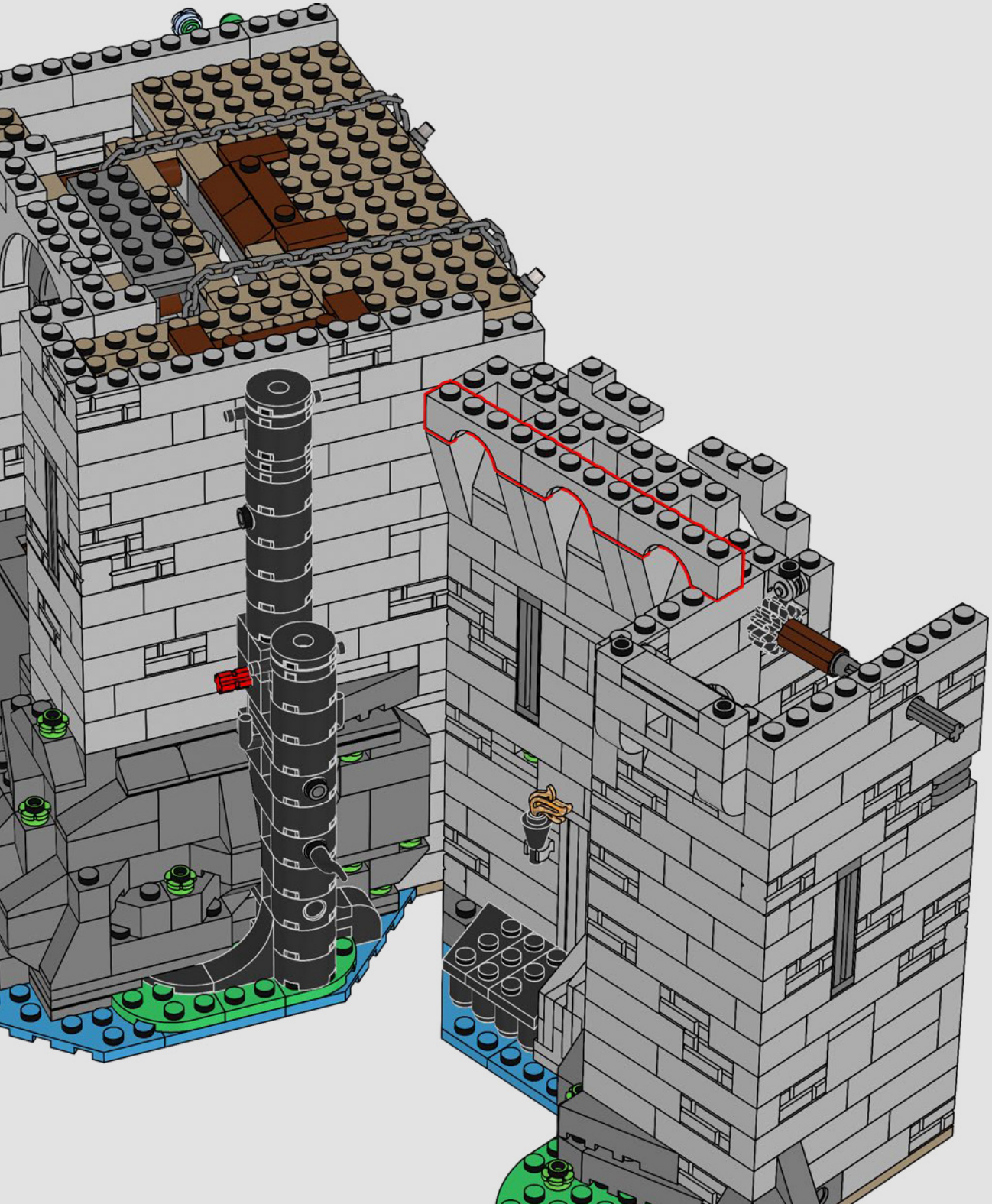

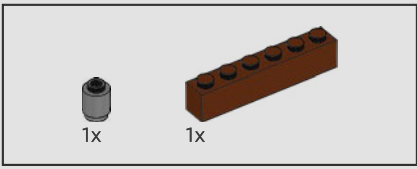

492

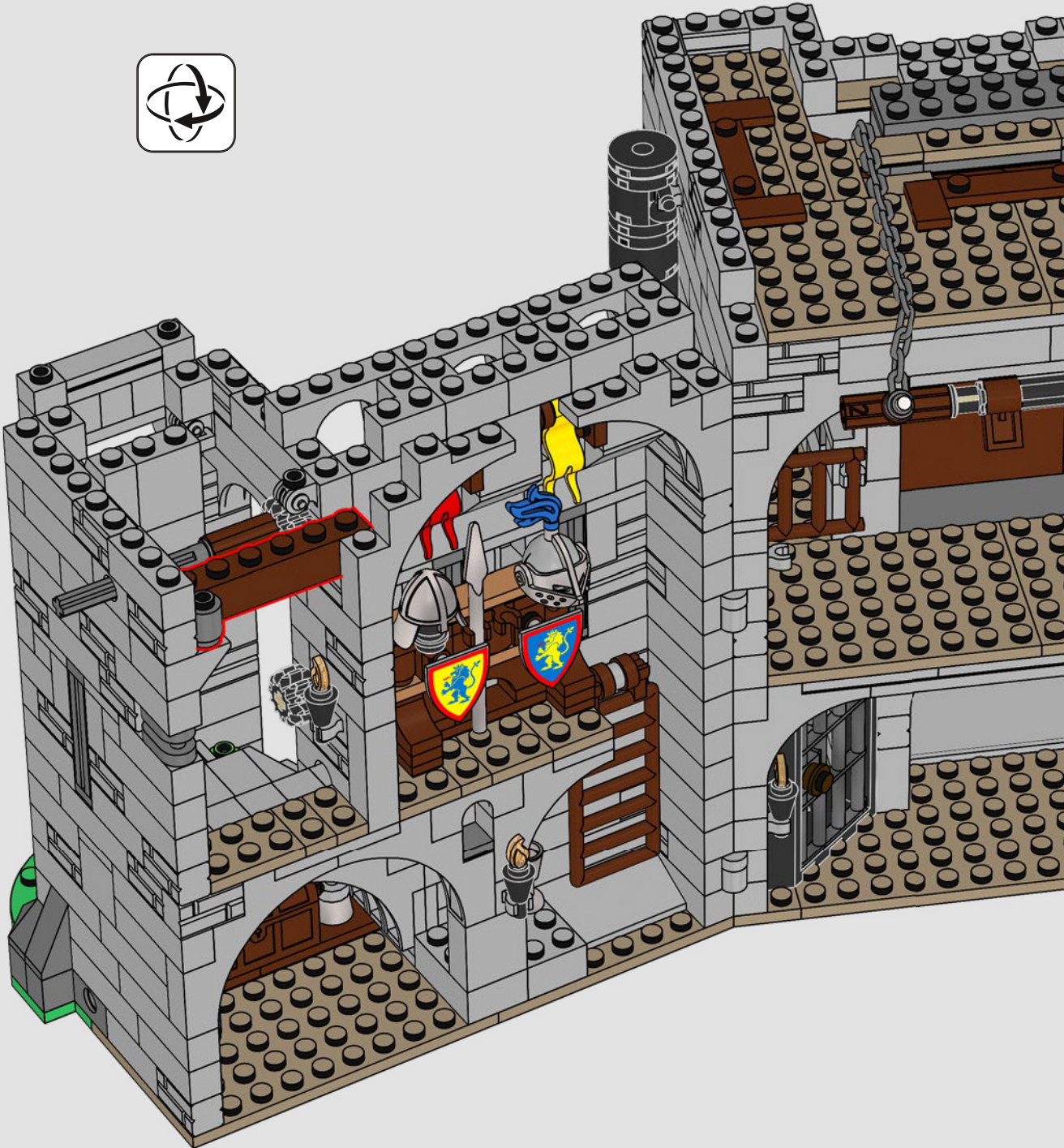

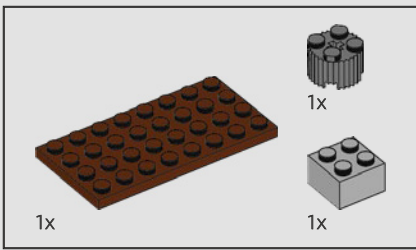

493

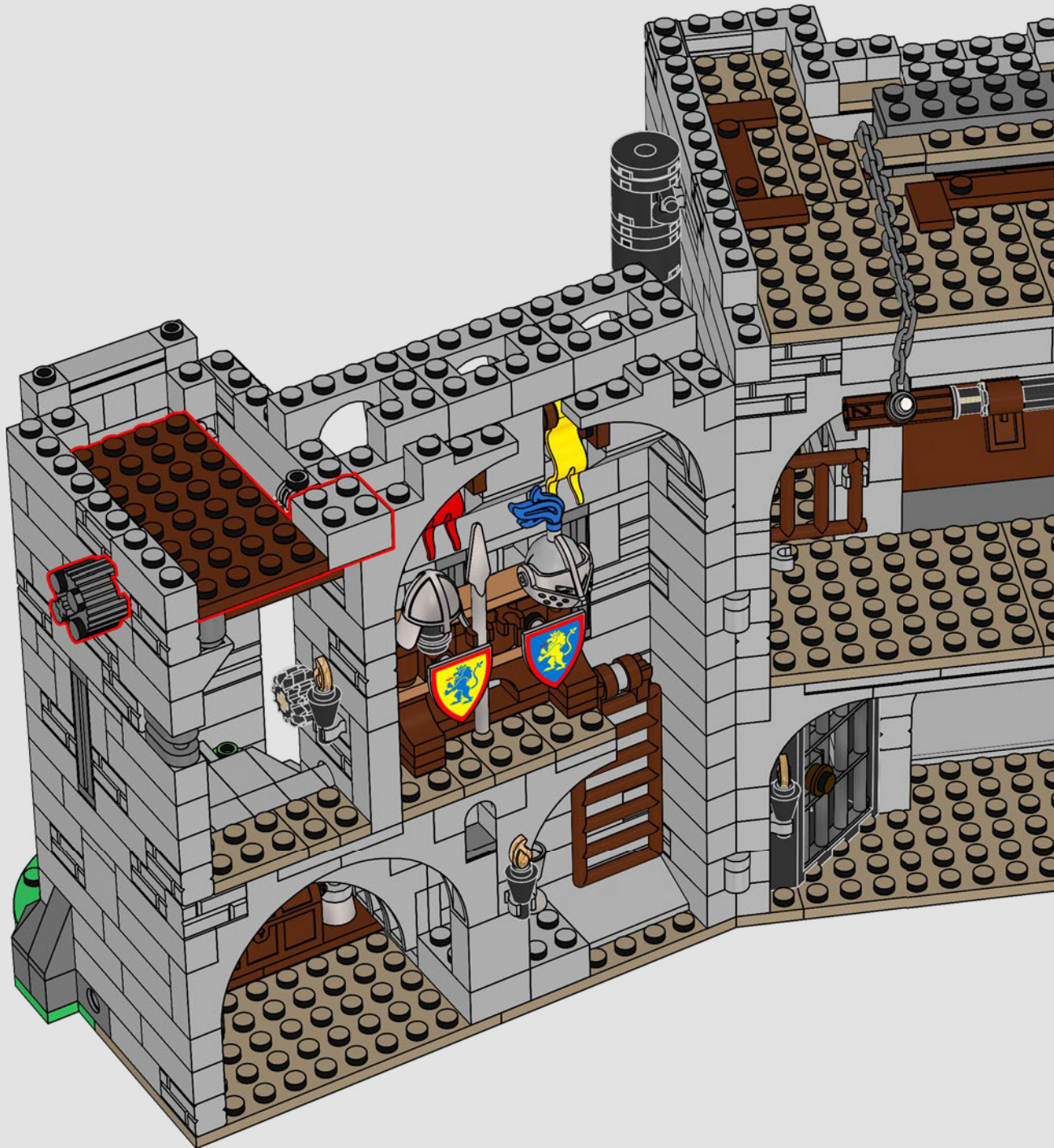

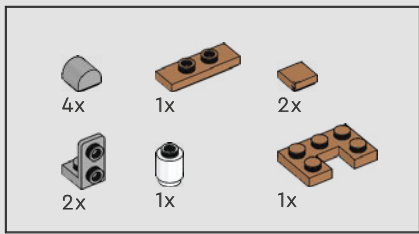

494

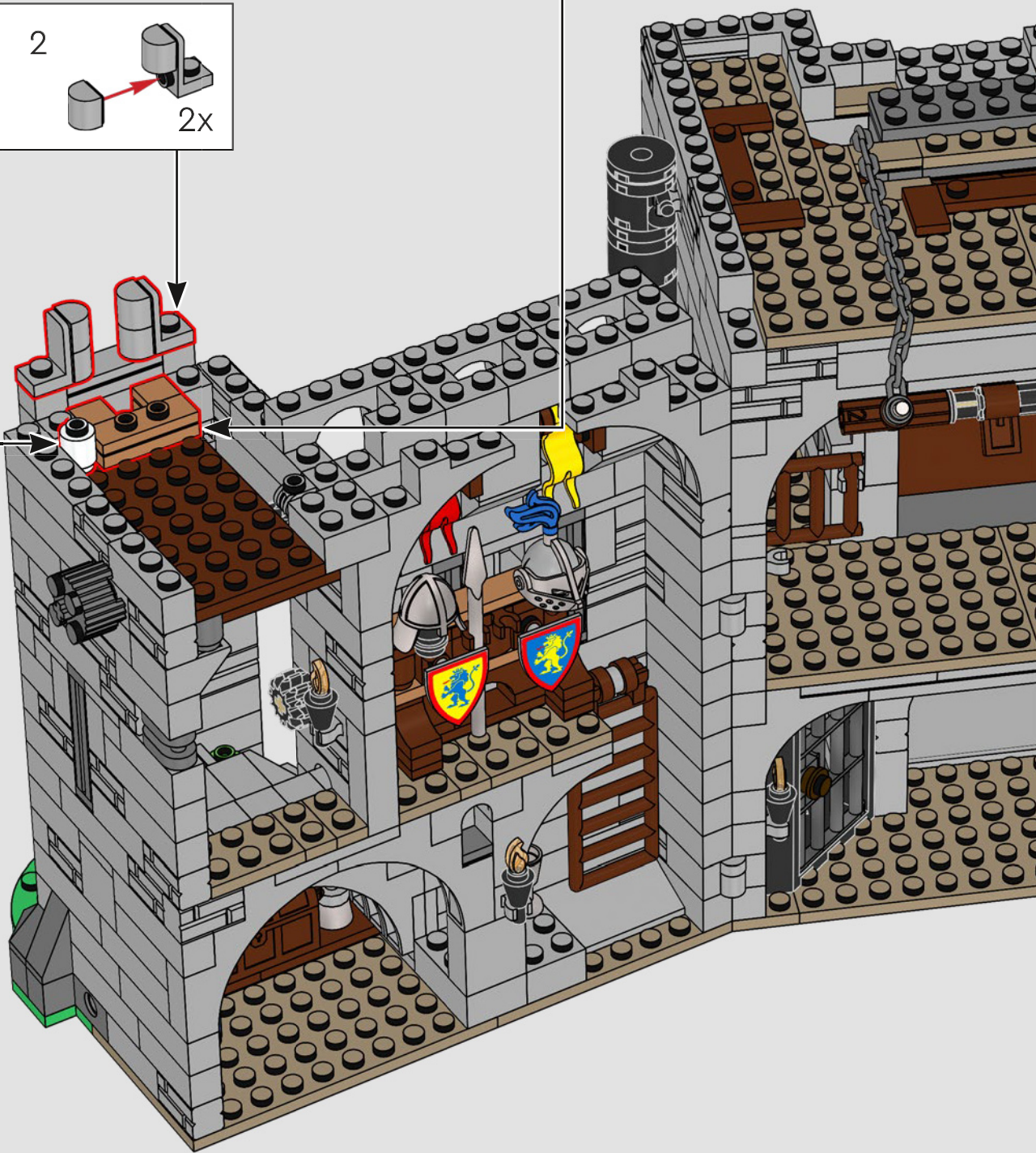
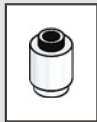
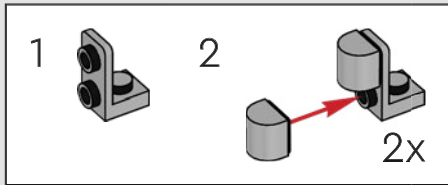
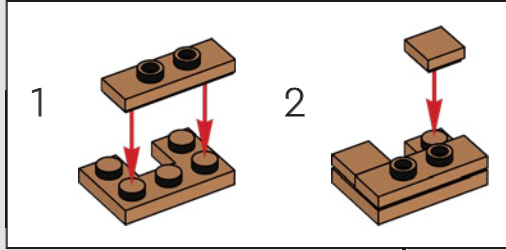



I've spent more time than I care to admit in this room, now if only I was able to sit down could I really put it to its proper use.

J'ai passé plus de temps que je ne veux l'admettre dans cette pièce. Maintenant, si seulement je pouvais m'asseoir, je pourrais vraiment l'utiliser à bon escient.

He pasado más tiempo del que me gustaría admitir en este lugar. Si tan solo pudiera sentarme, le daría el uso adecuado.

495

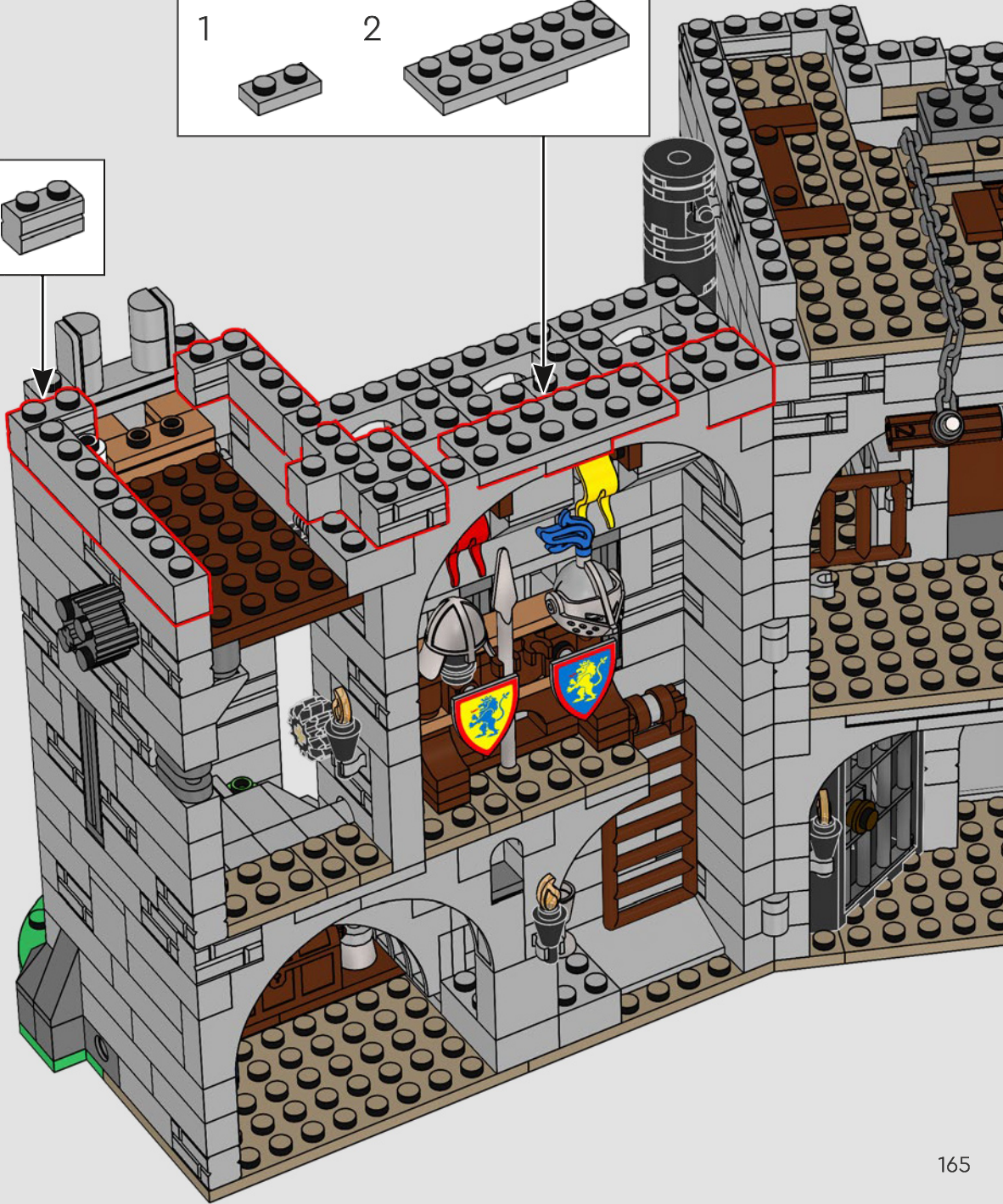
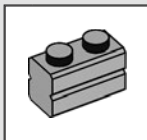
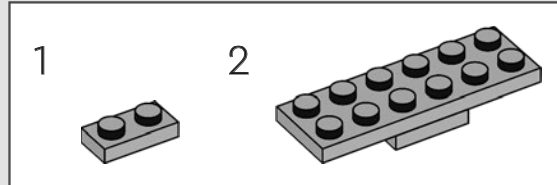
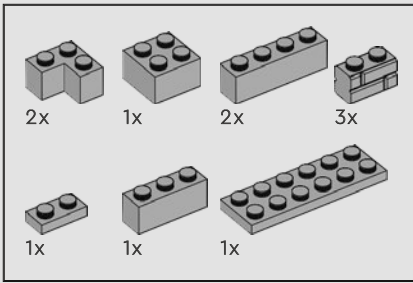

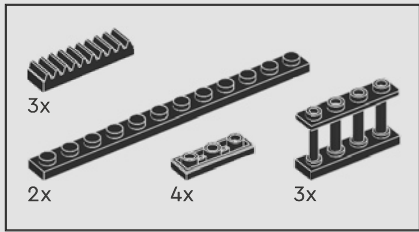

496

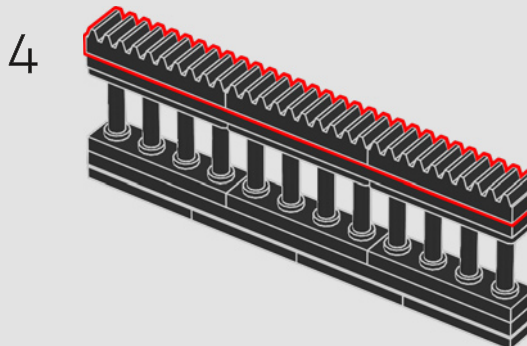
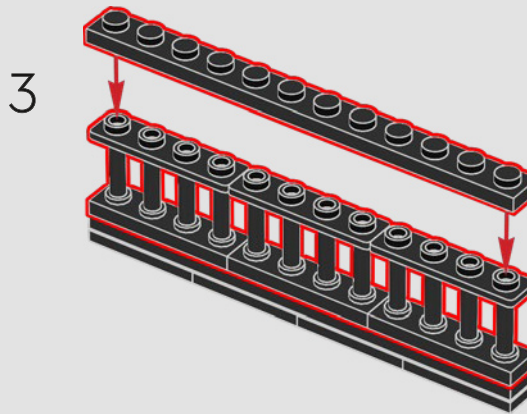
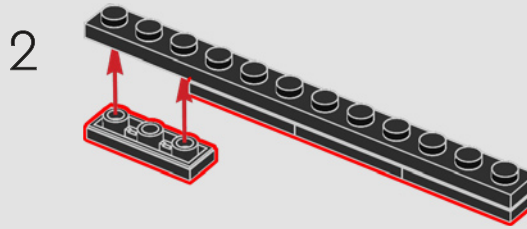
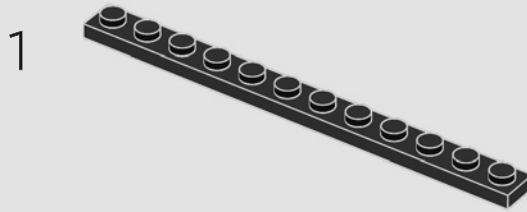

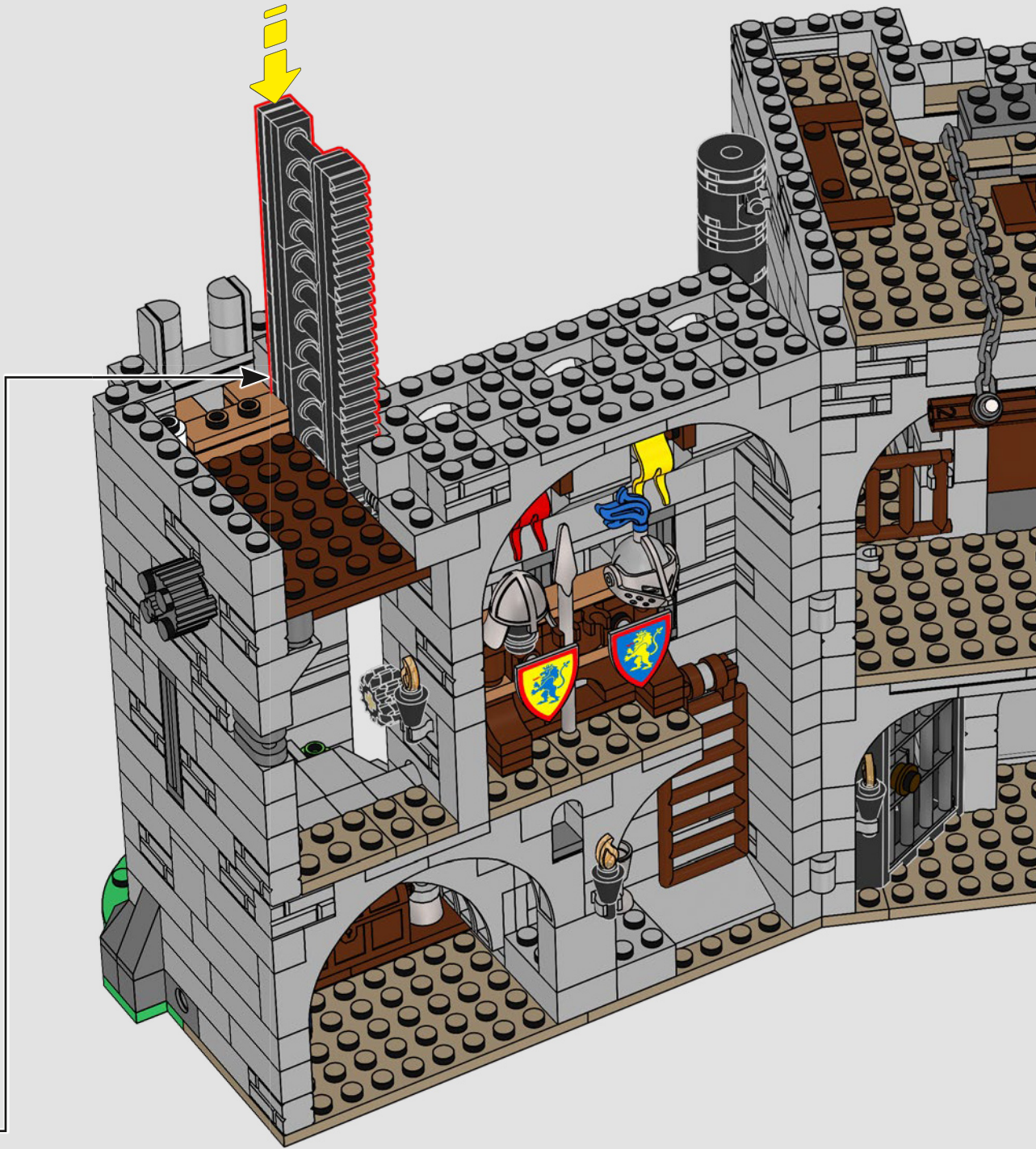

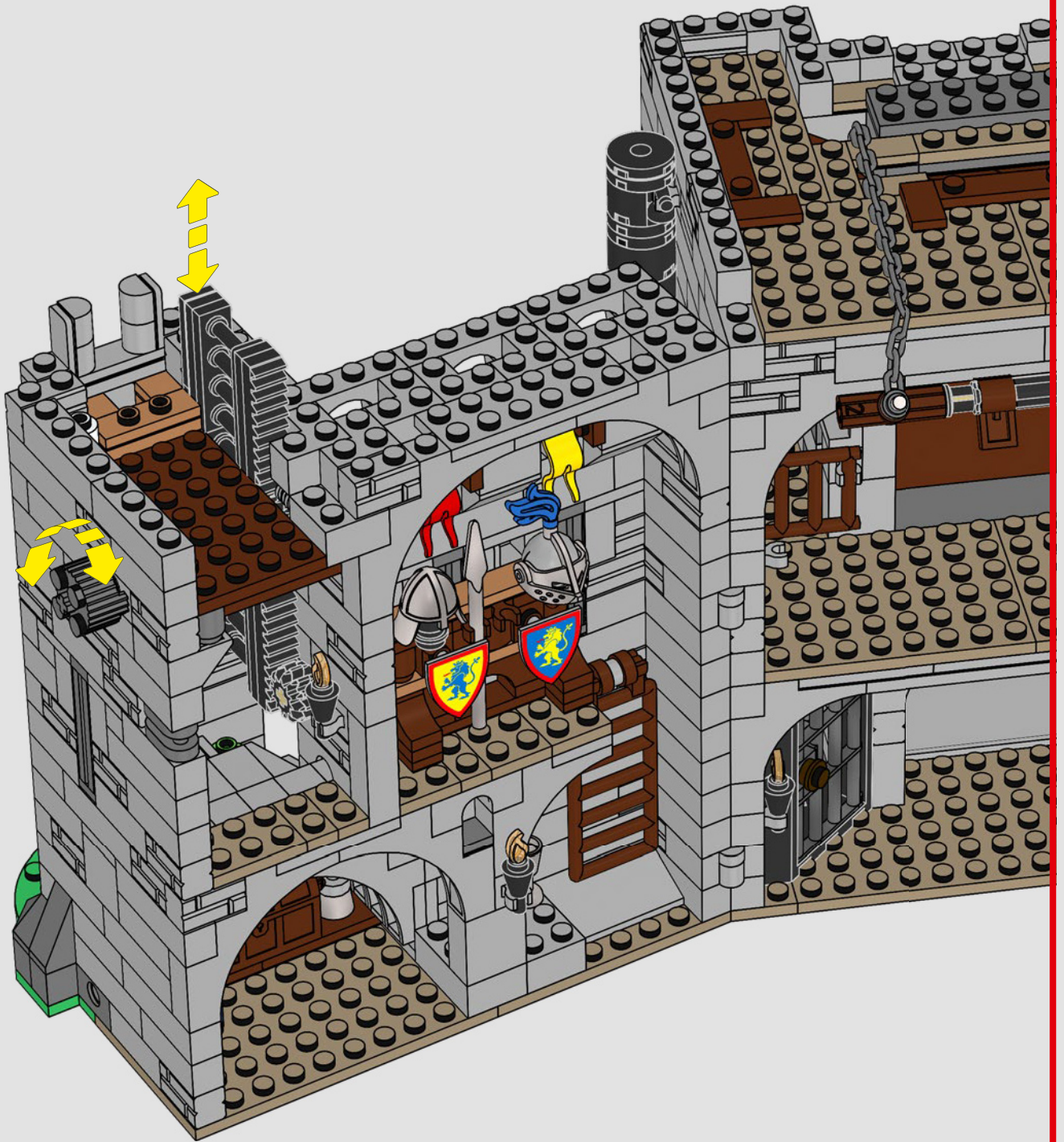

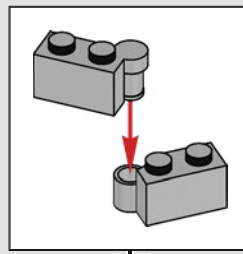
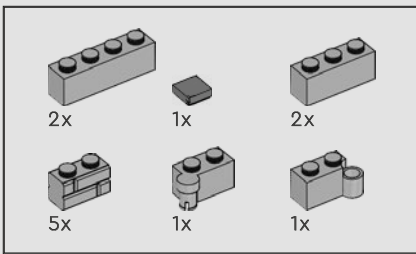

497

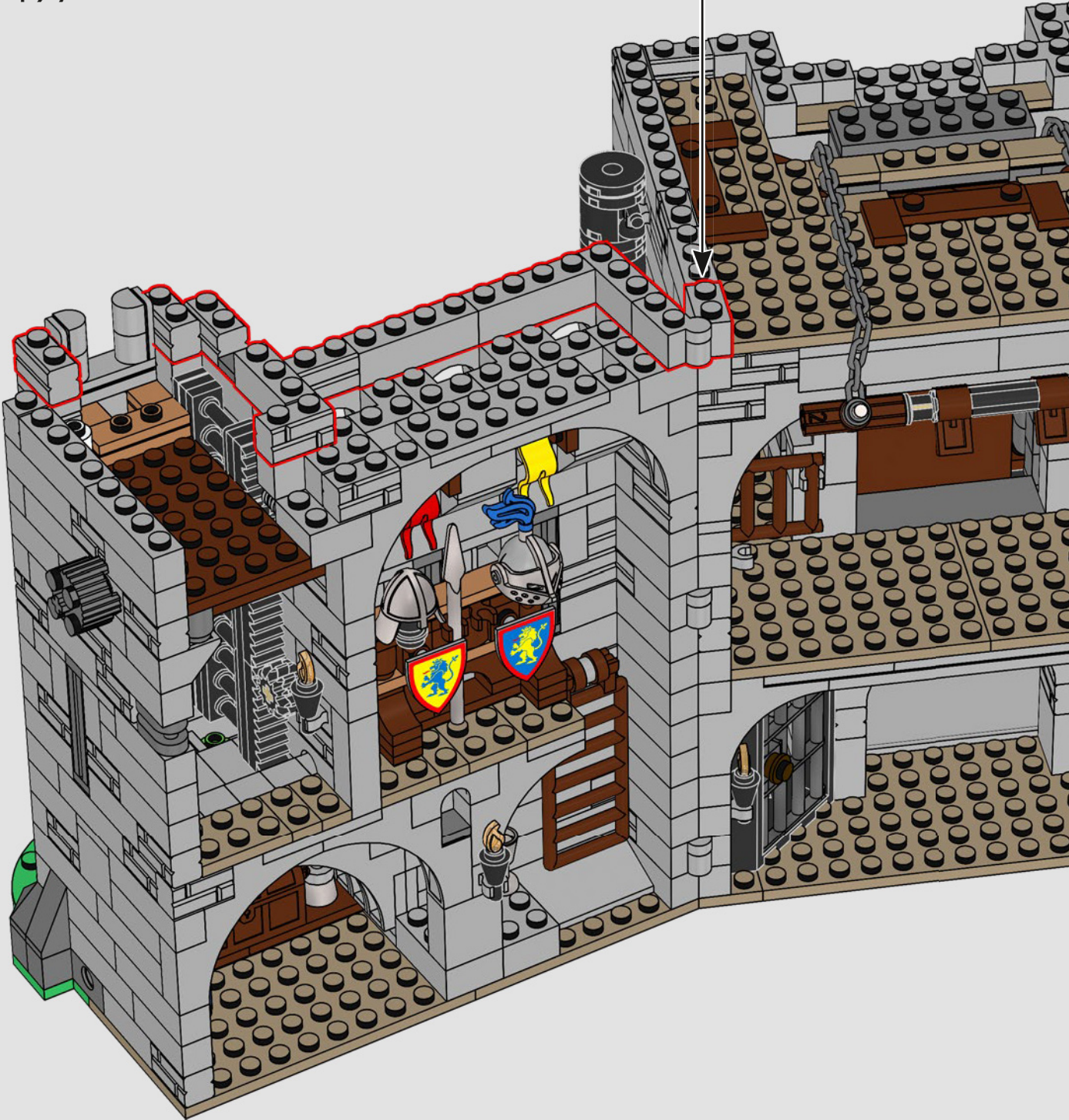

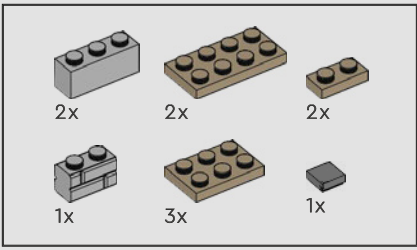

498

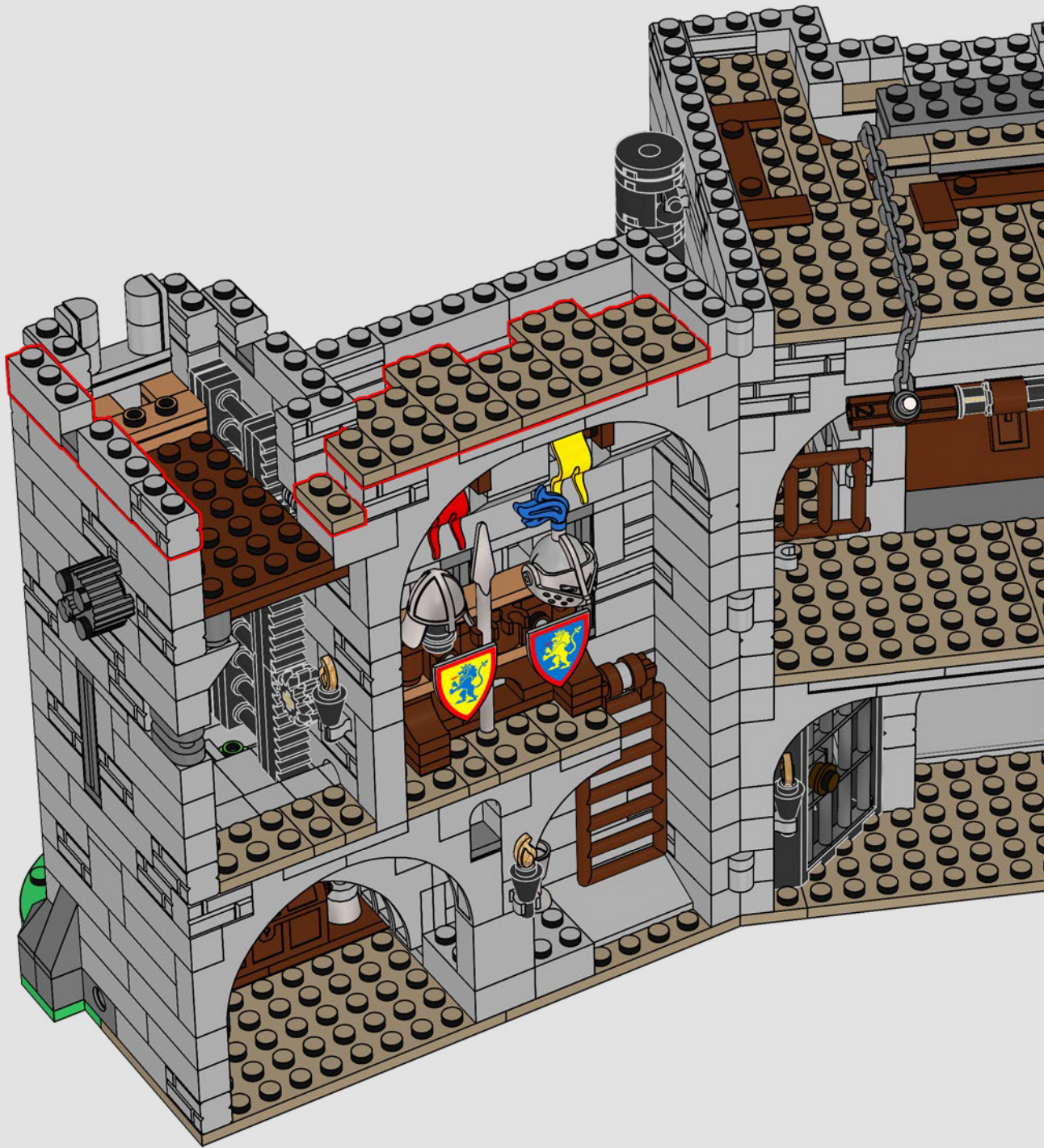

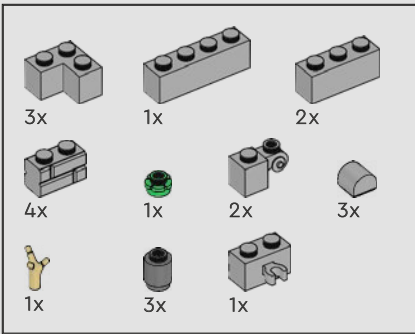

499

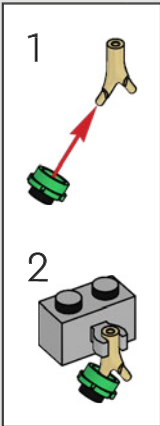
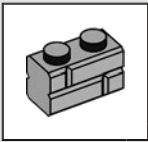

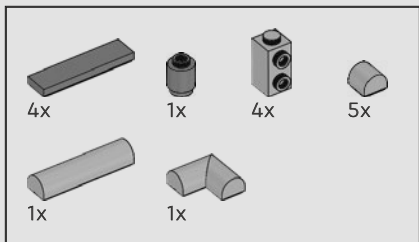

500

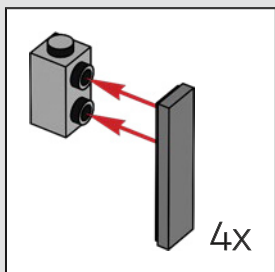

These large stones will come in handy! We can drop them through the machicolations should the dragon army ever approach our back gate!

Ces grosses pierres seront très utiles ! On peut les lâcher à travers les mâchicoulis si jamais l'armée des dragons s'approche de notre porte arrière !

Estas grandes piedras serán muy útiles. ¡Podemos dejarlas caer por los matacanes si el Ejército Dragón alguna vez se acerca a nuestra entrada posterior!

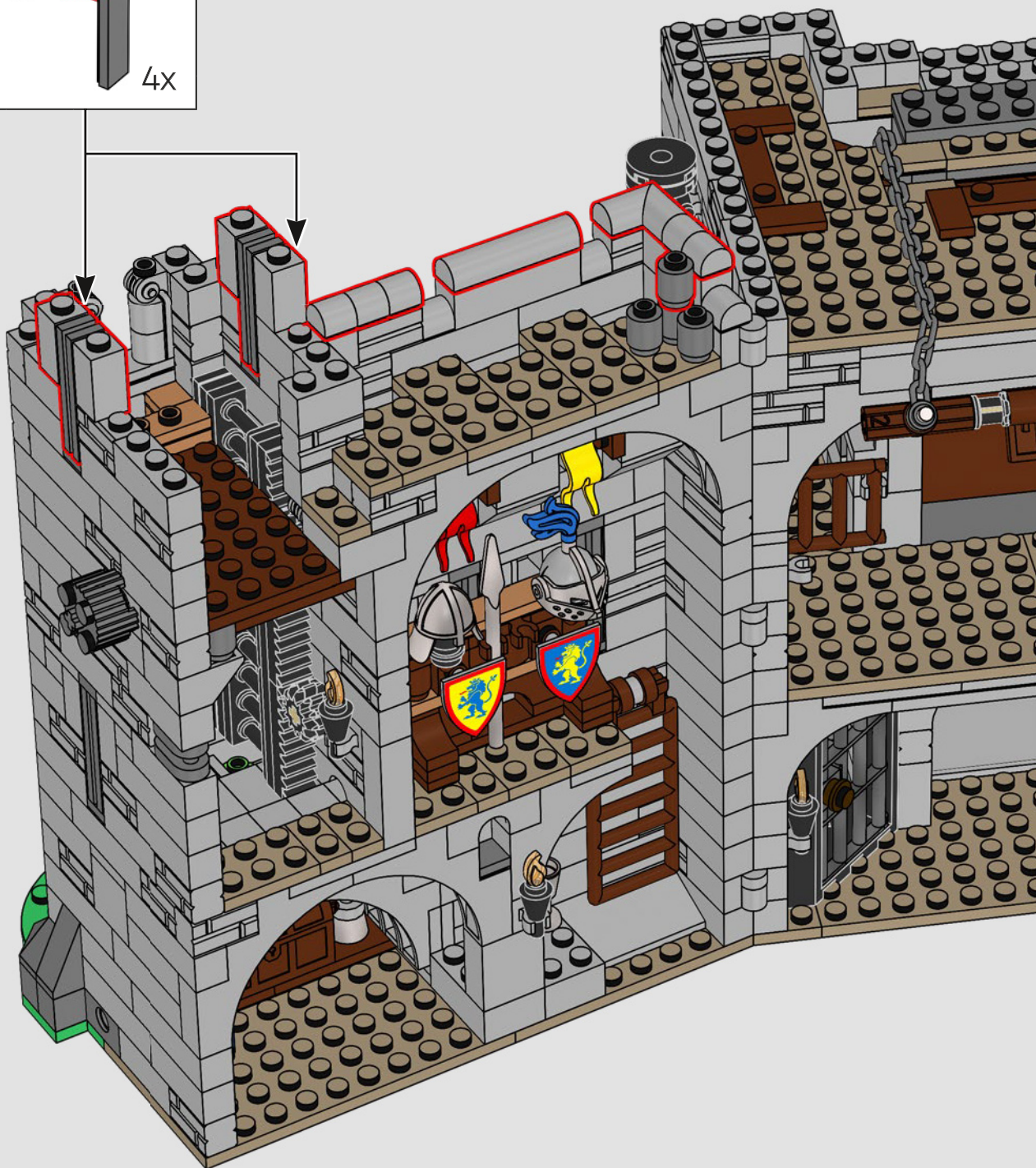

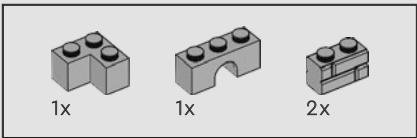

502

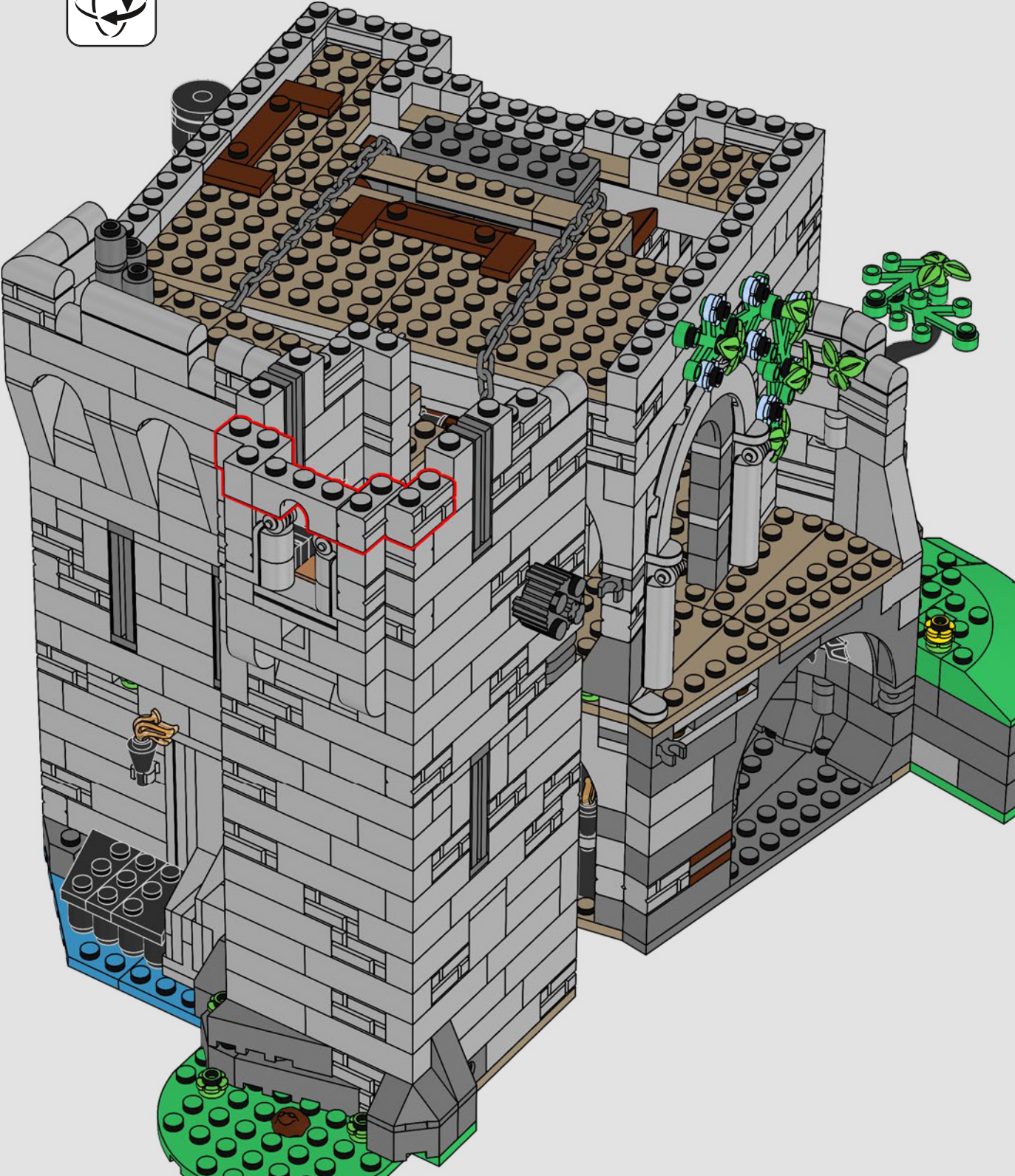

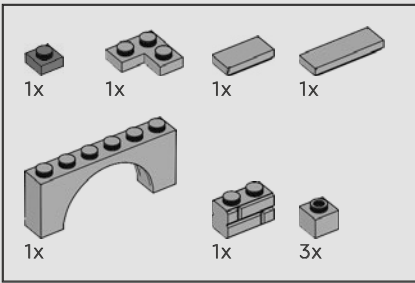

503



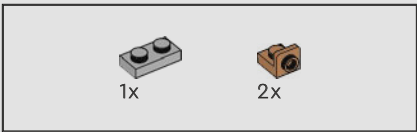

504



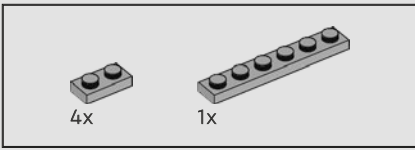

505



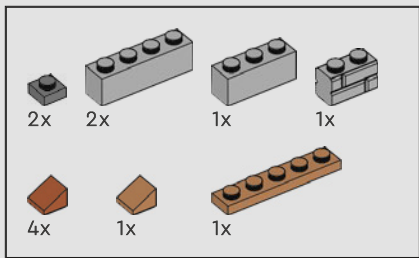

506

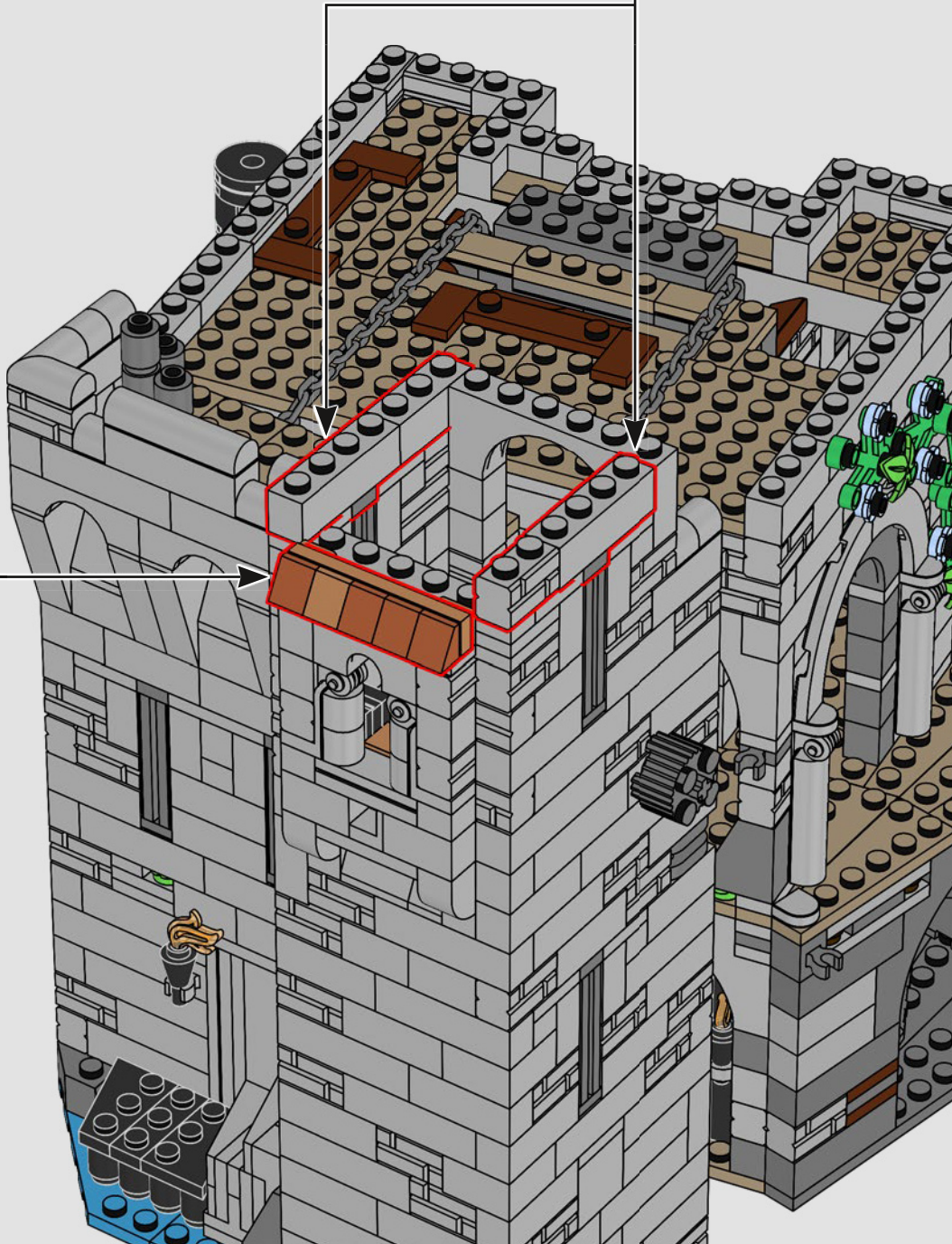
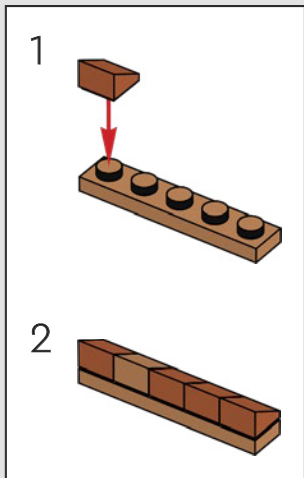
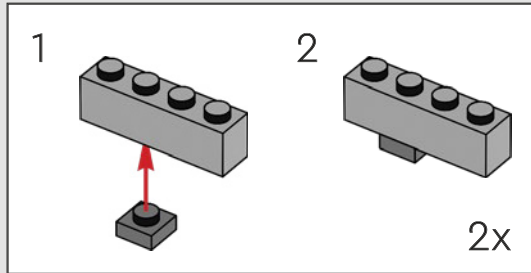

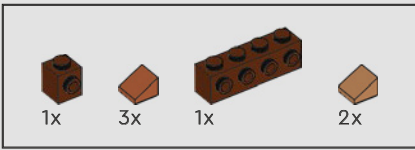

507

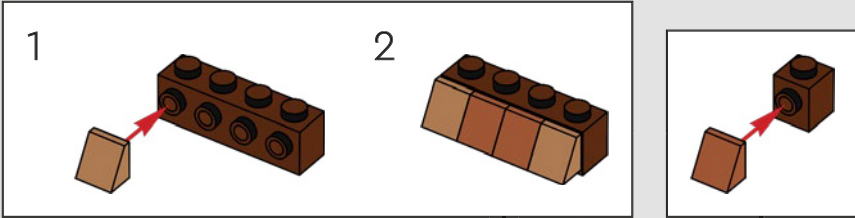

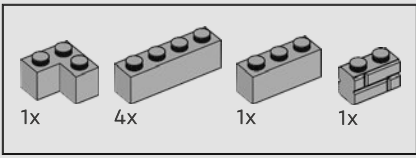

508

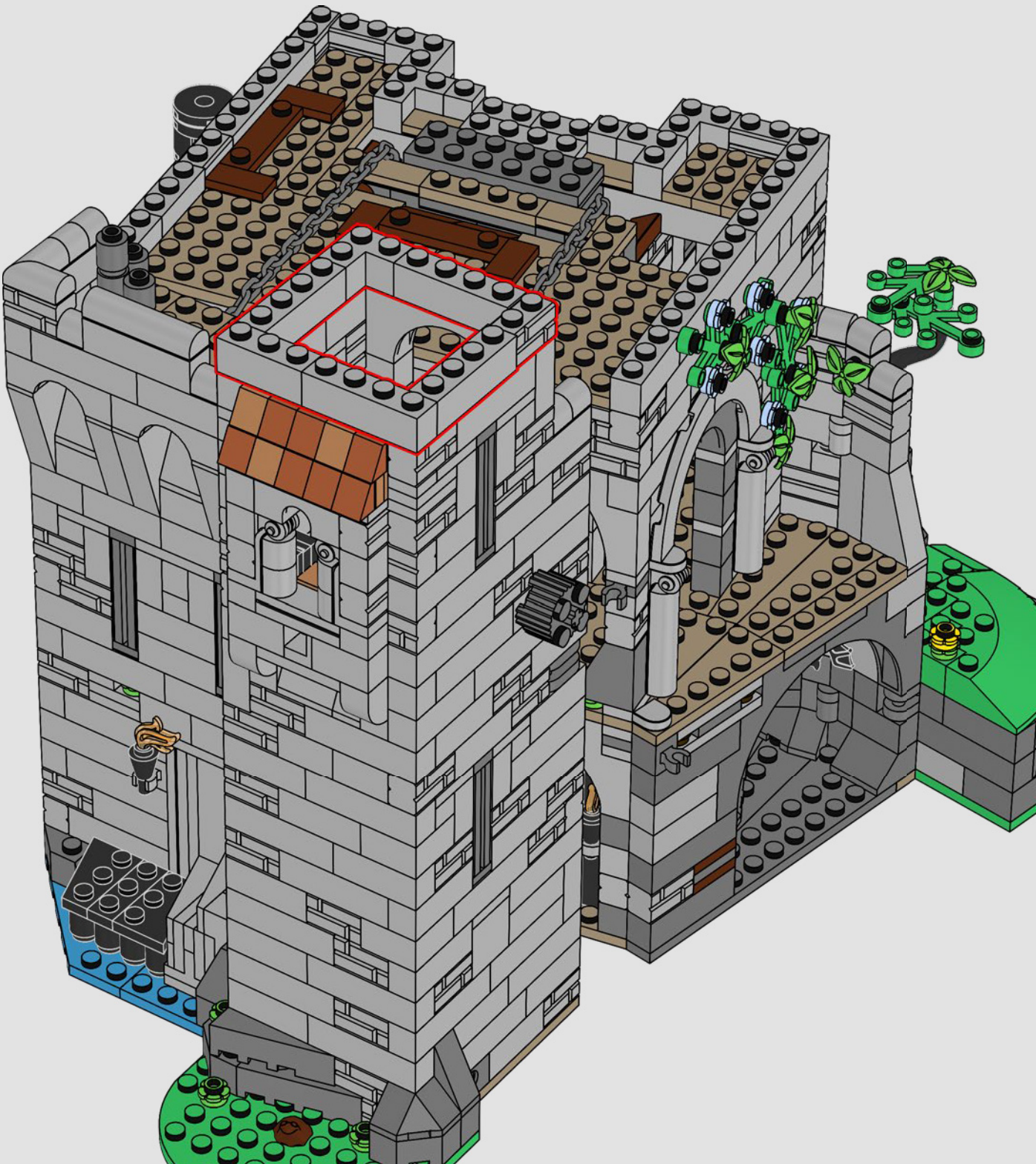

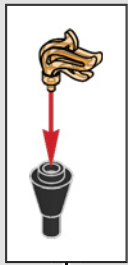

509

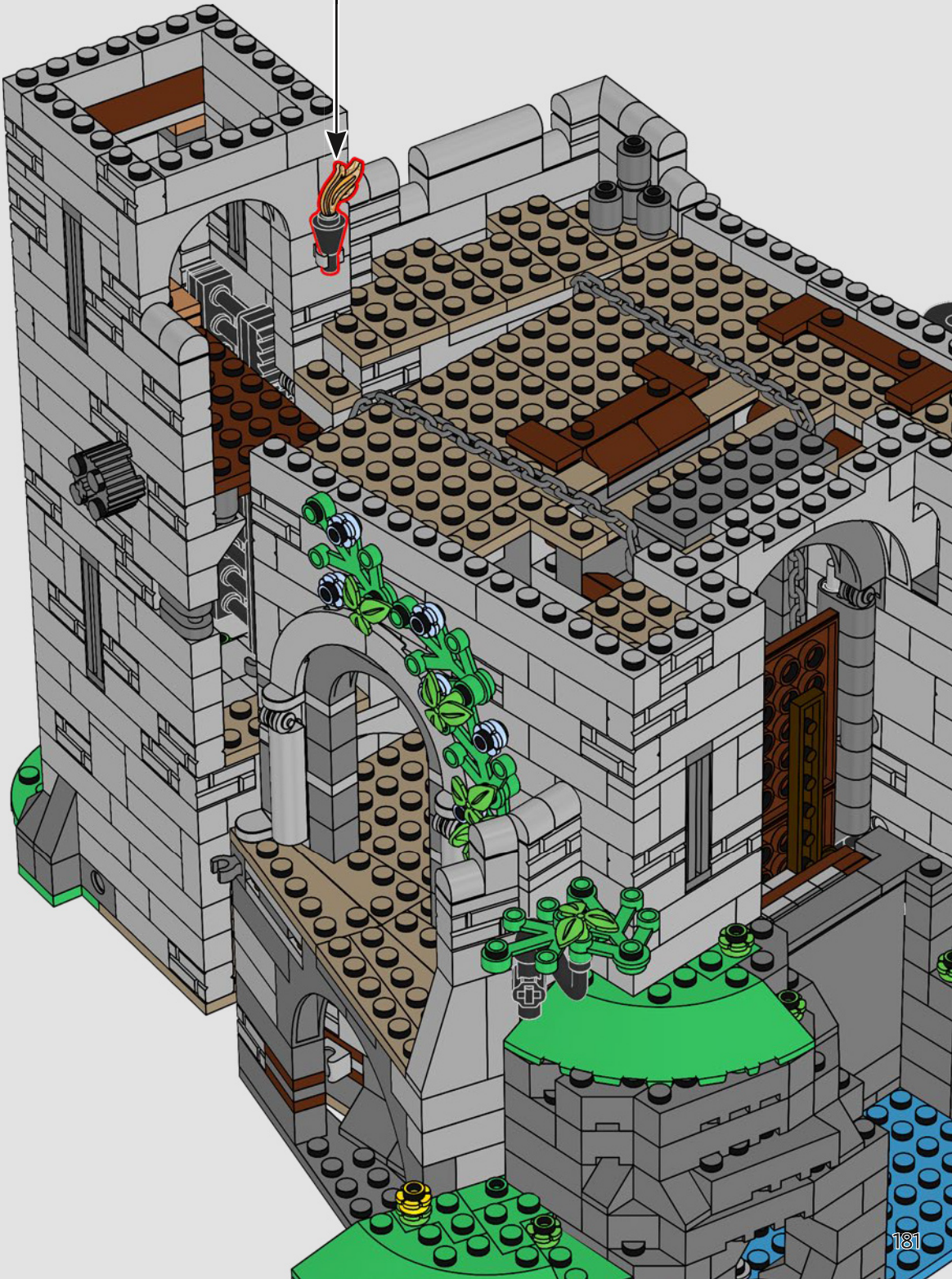



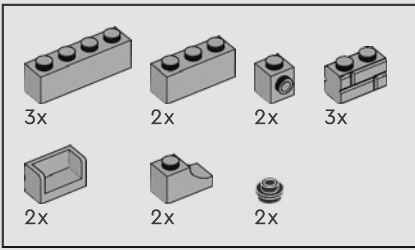

510

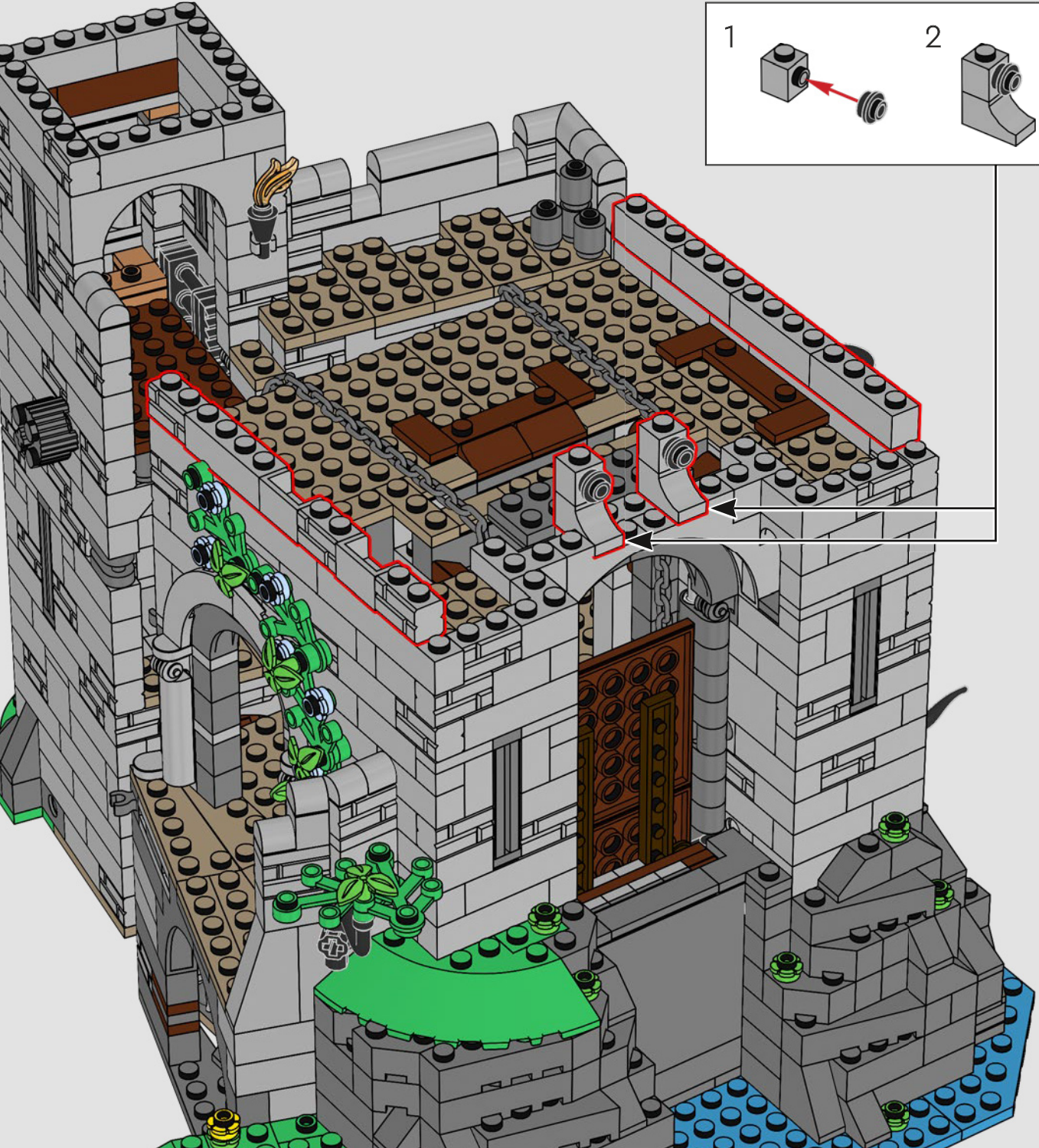
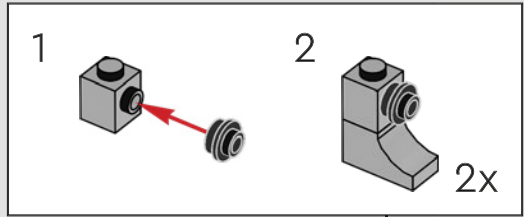

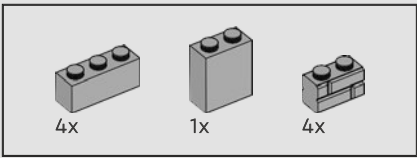

511

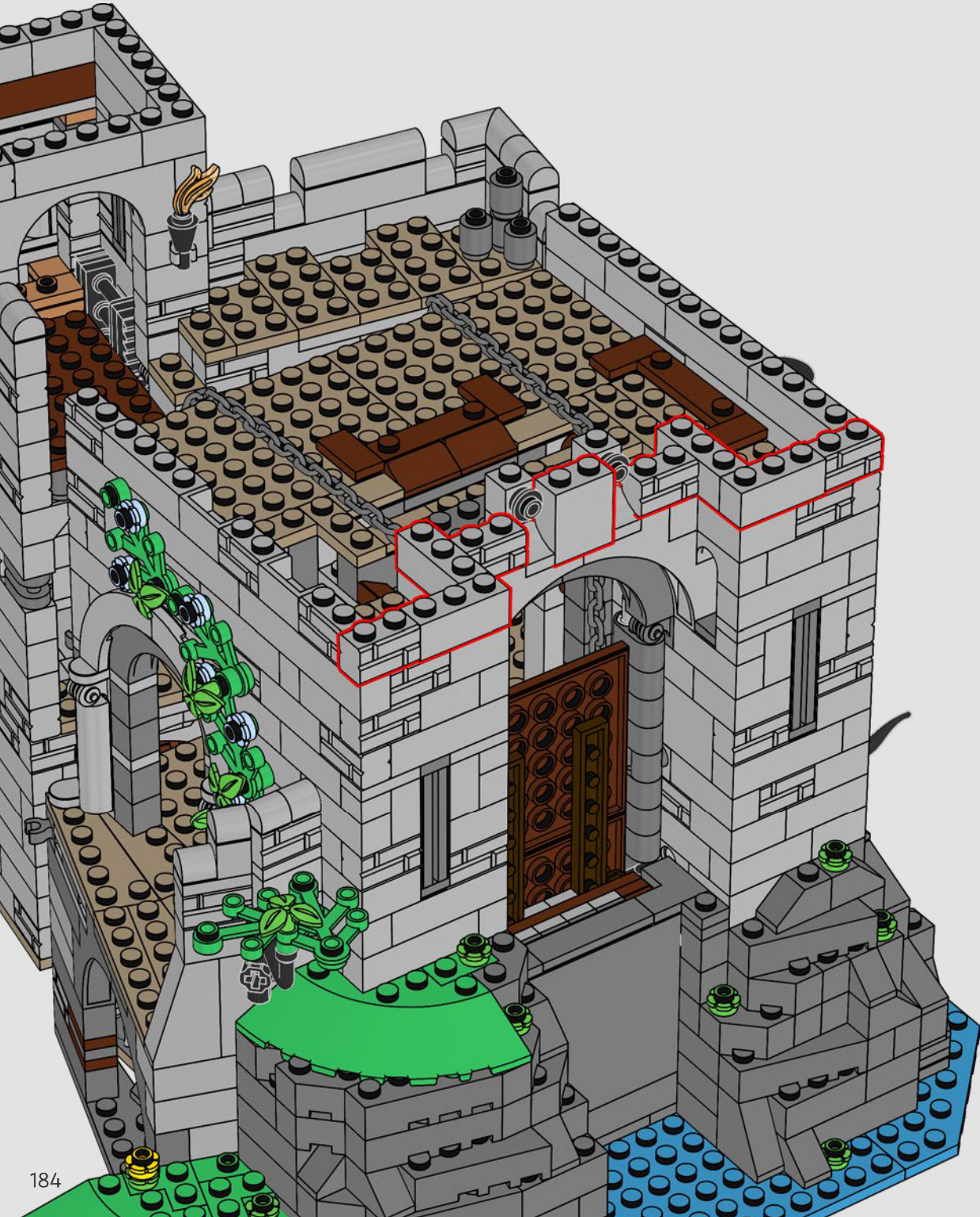

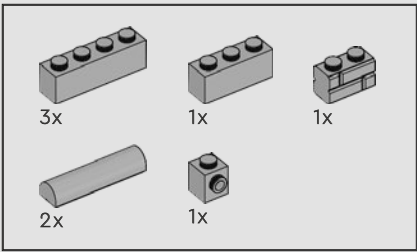

512

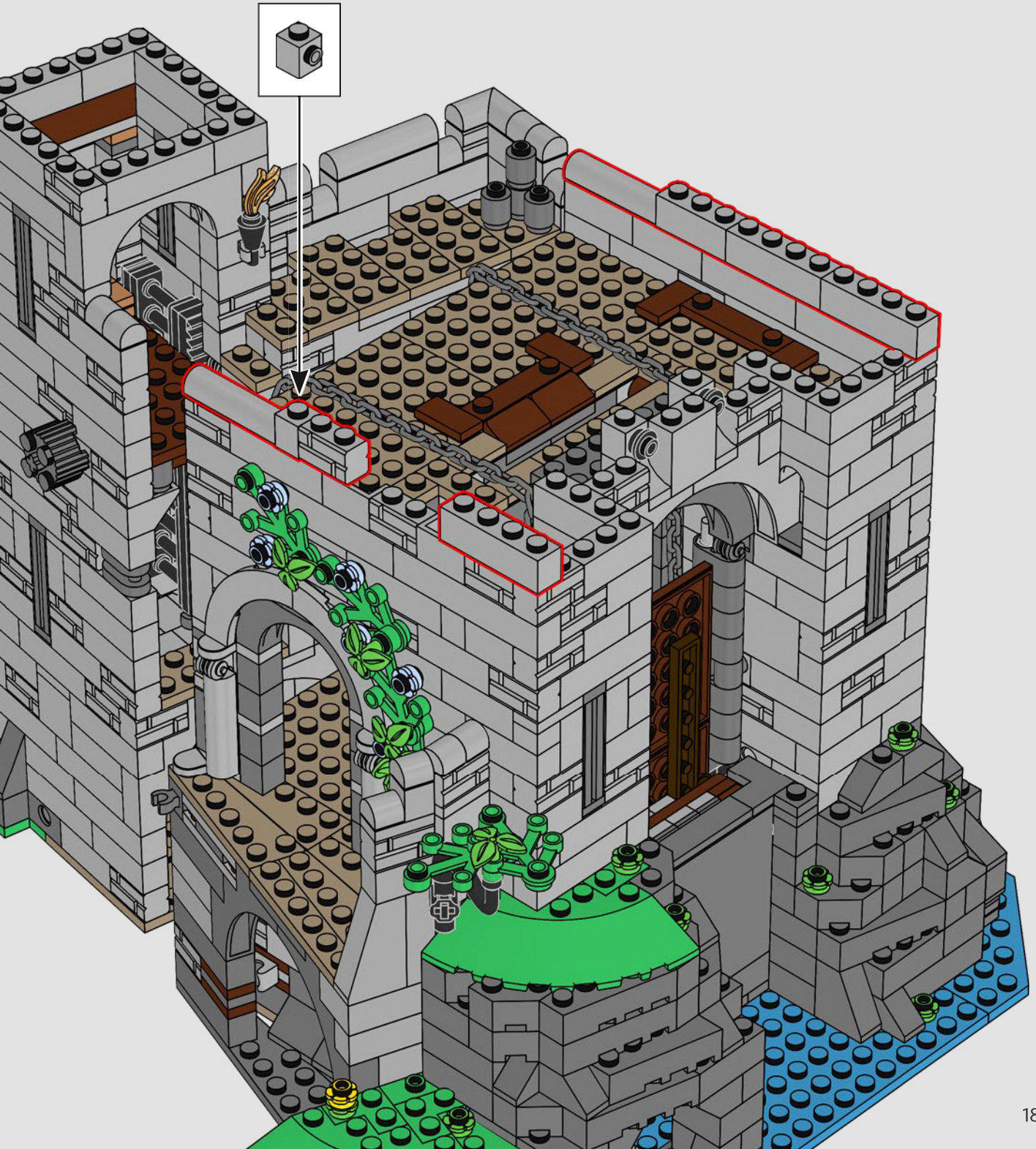



513

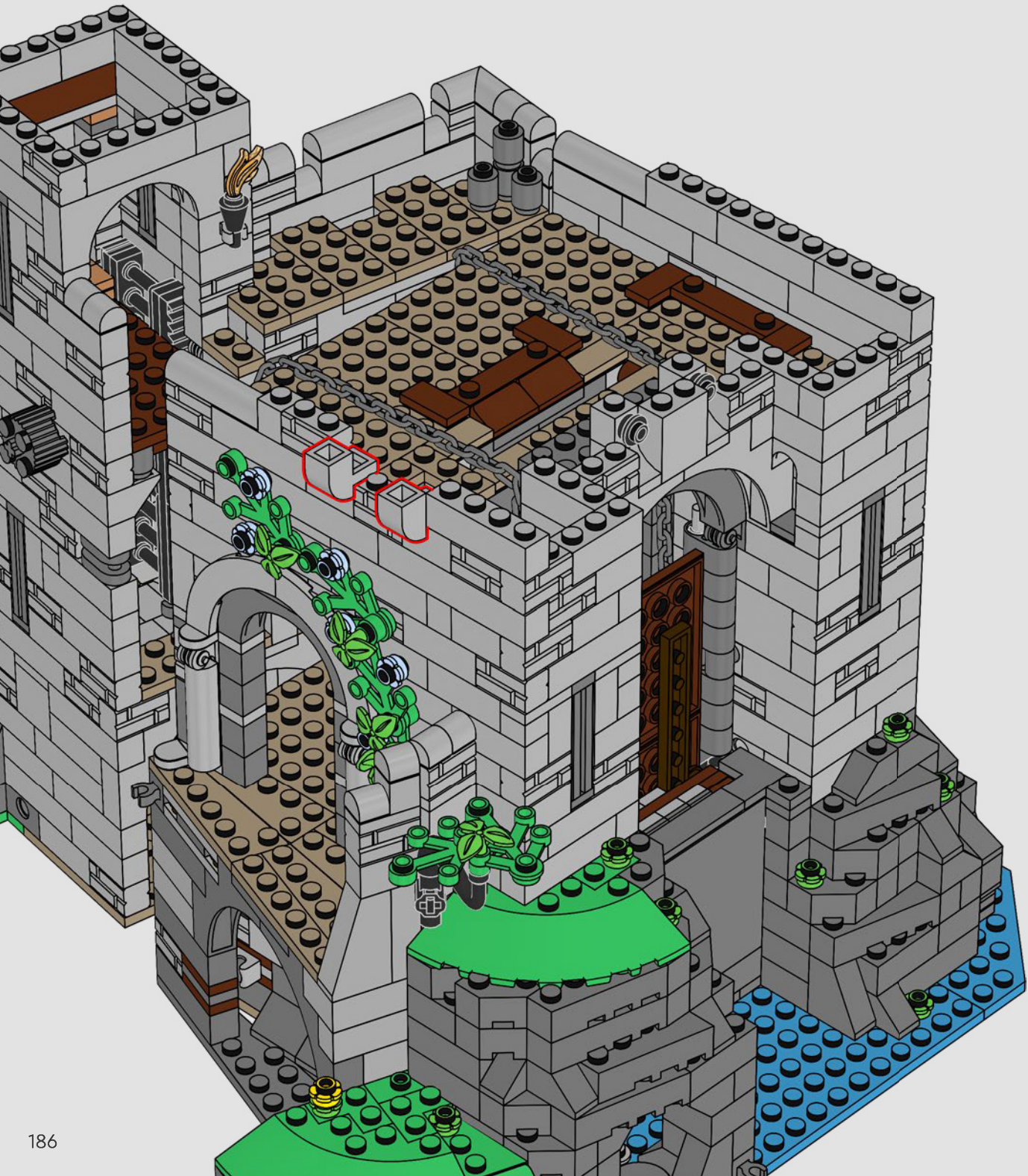

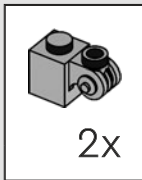
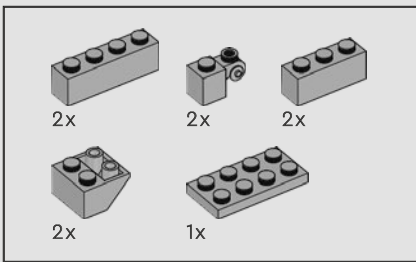

514

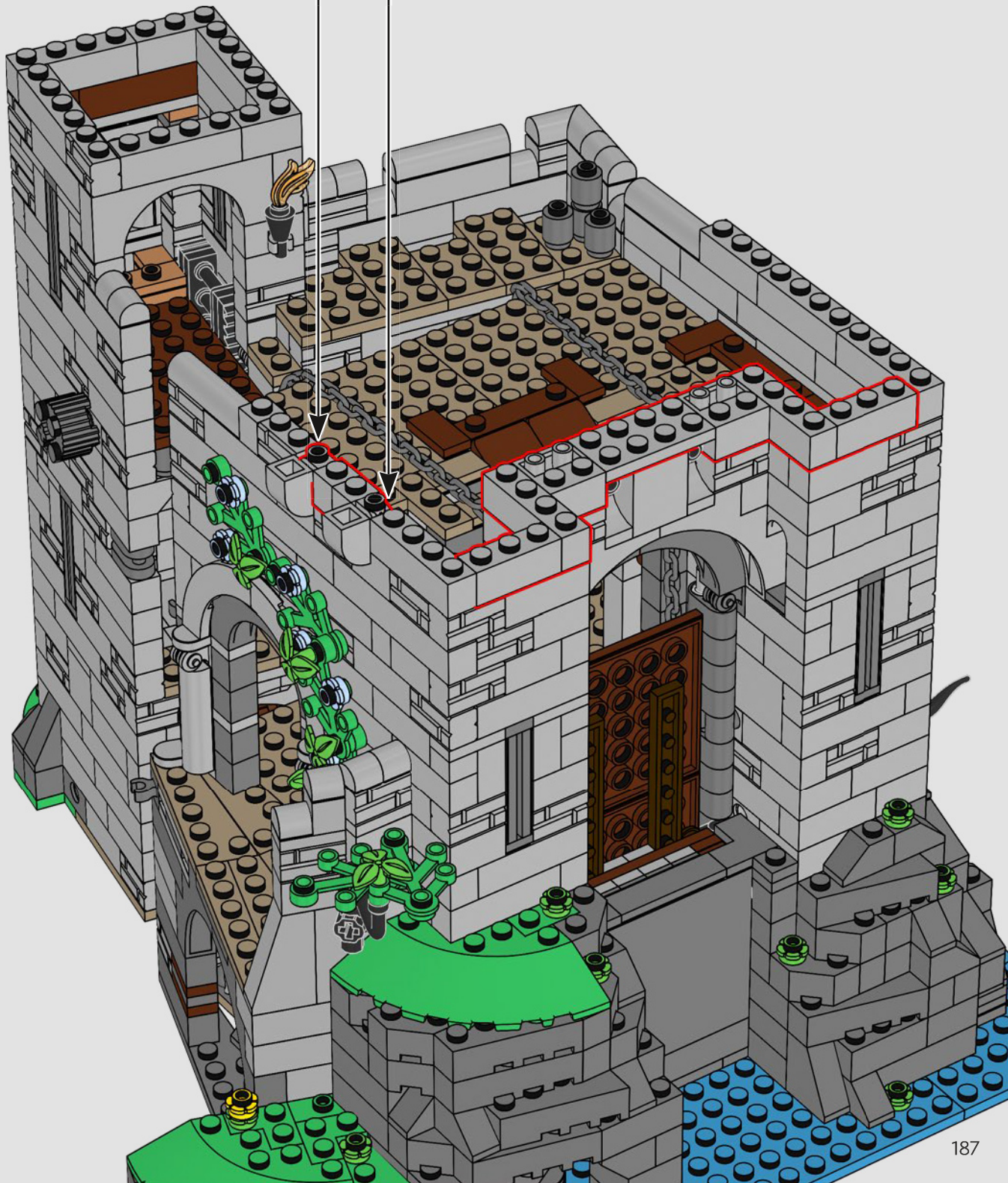

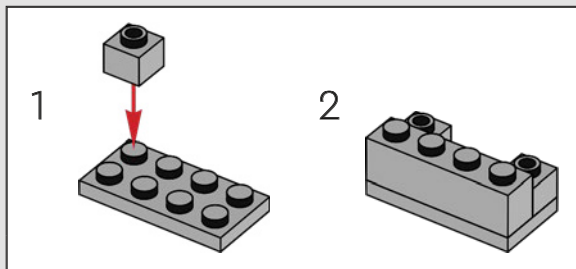
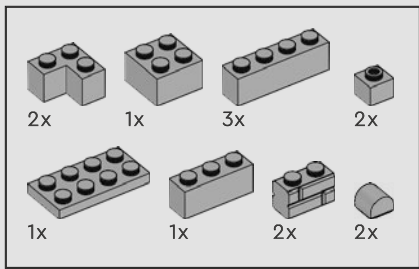

515

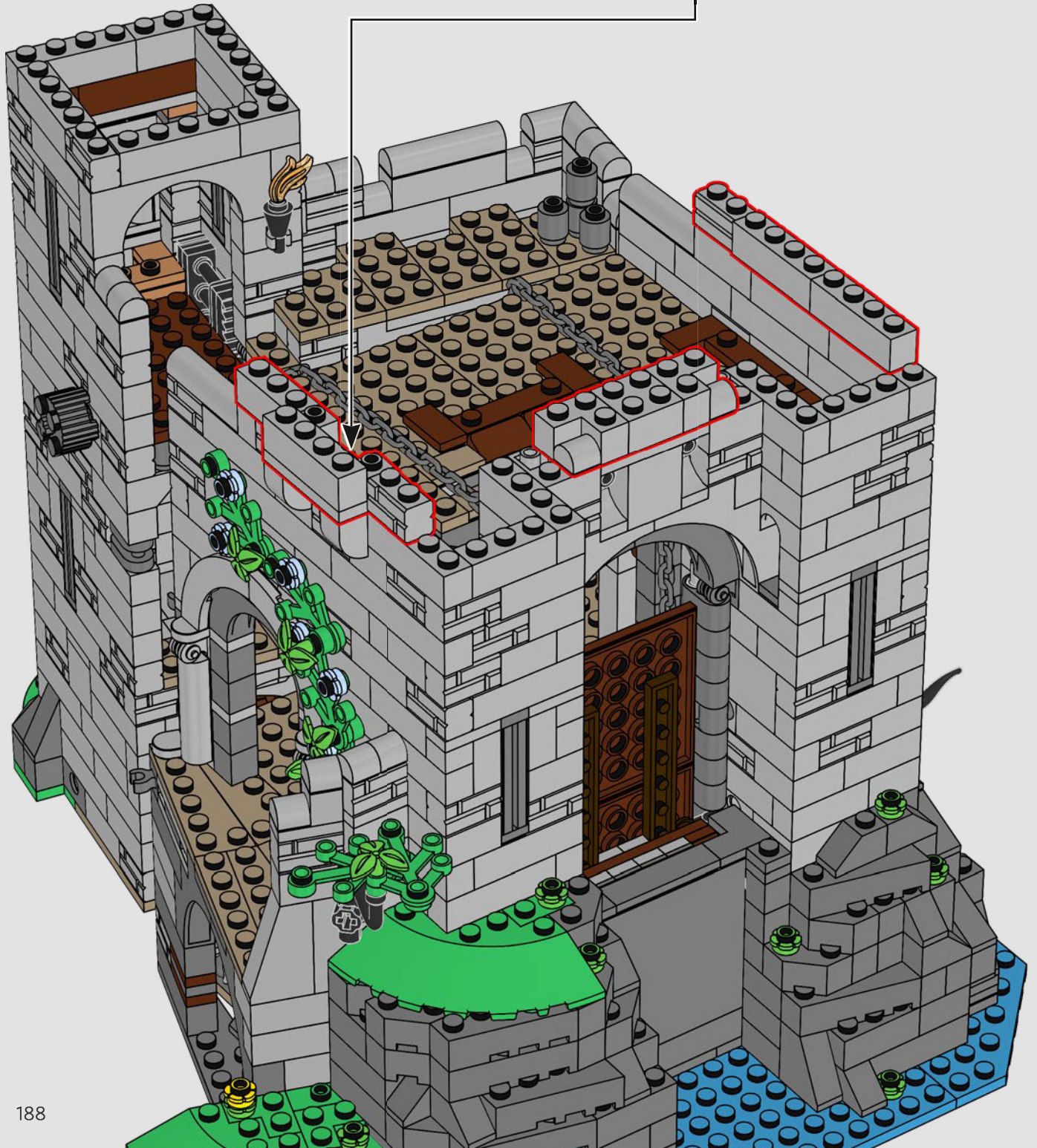

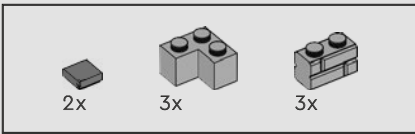

516

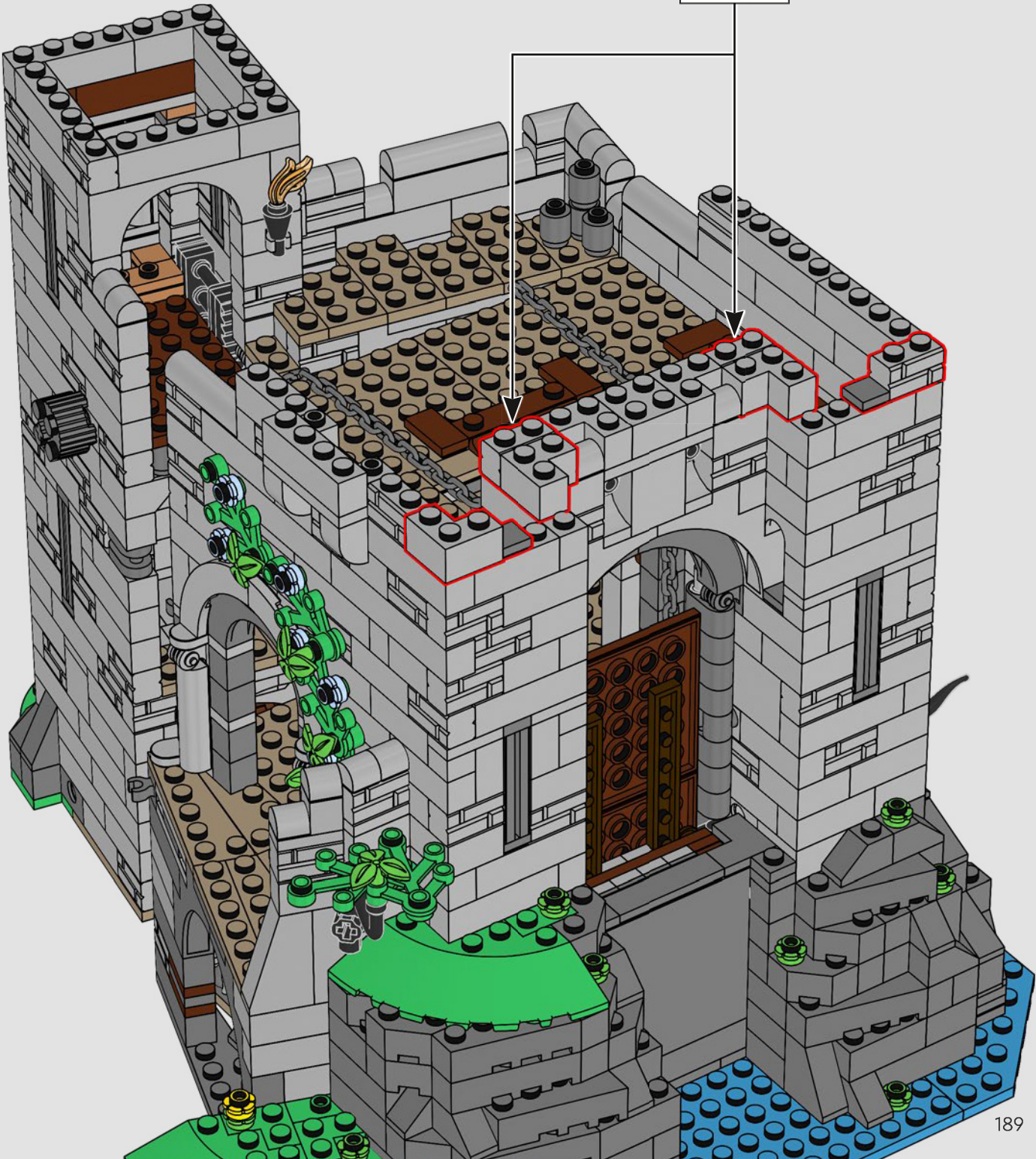
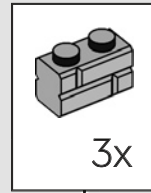

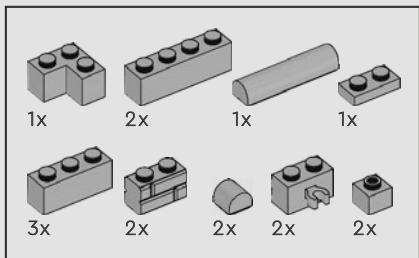

517

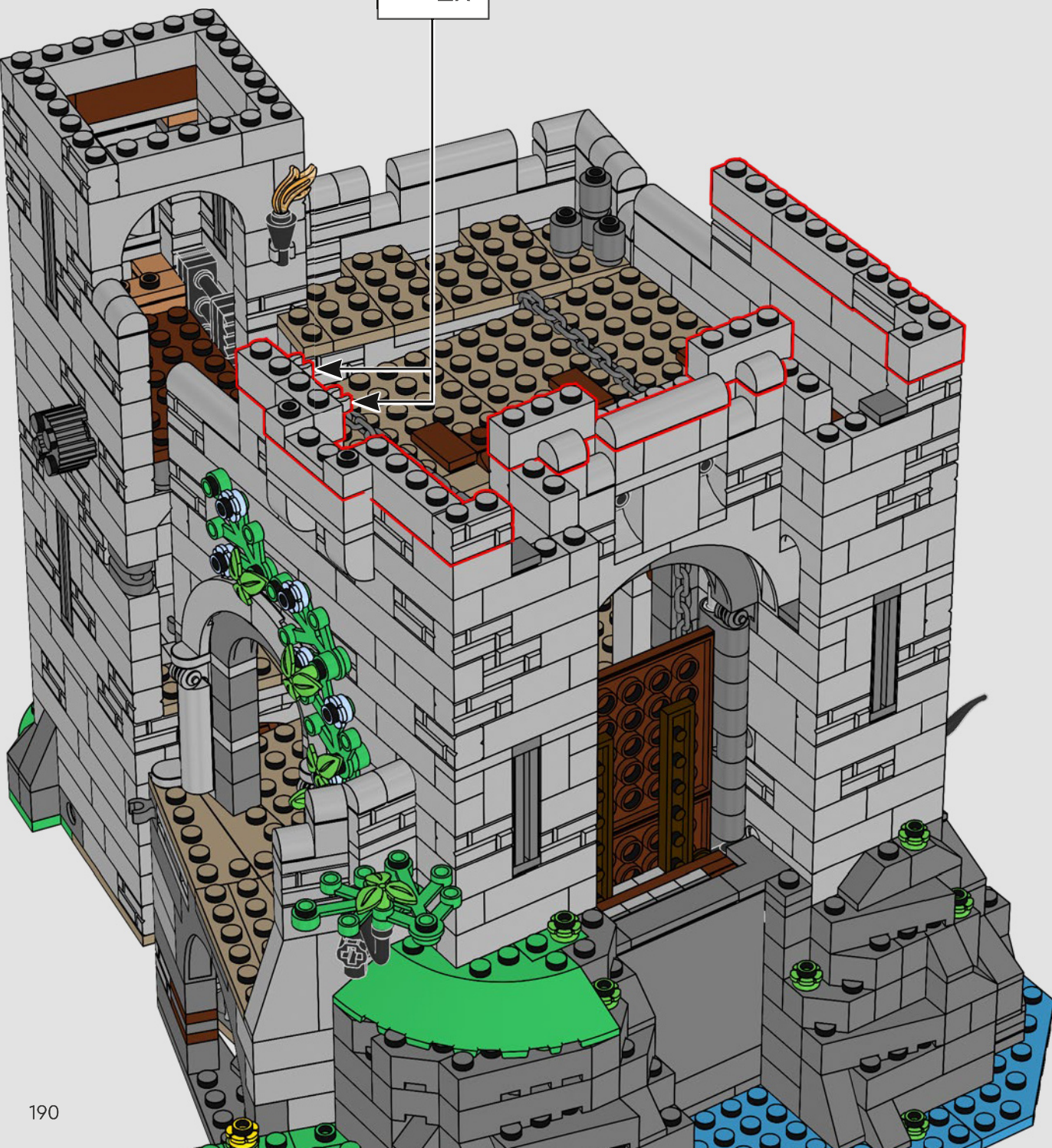
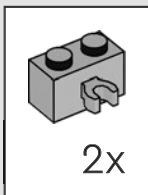

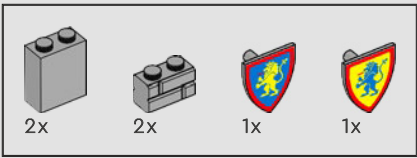

518

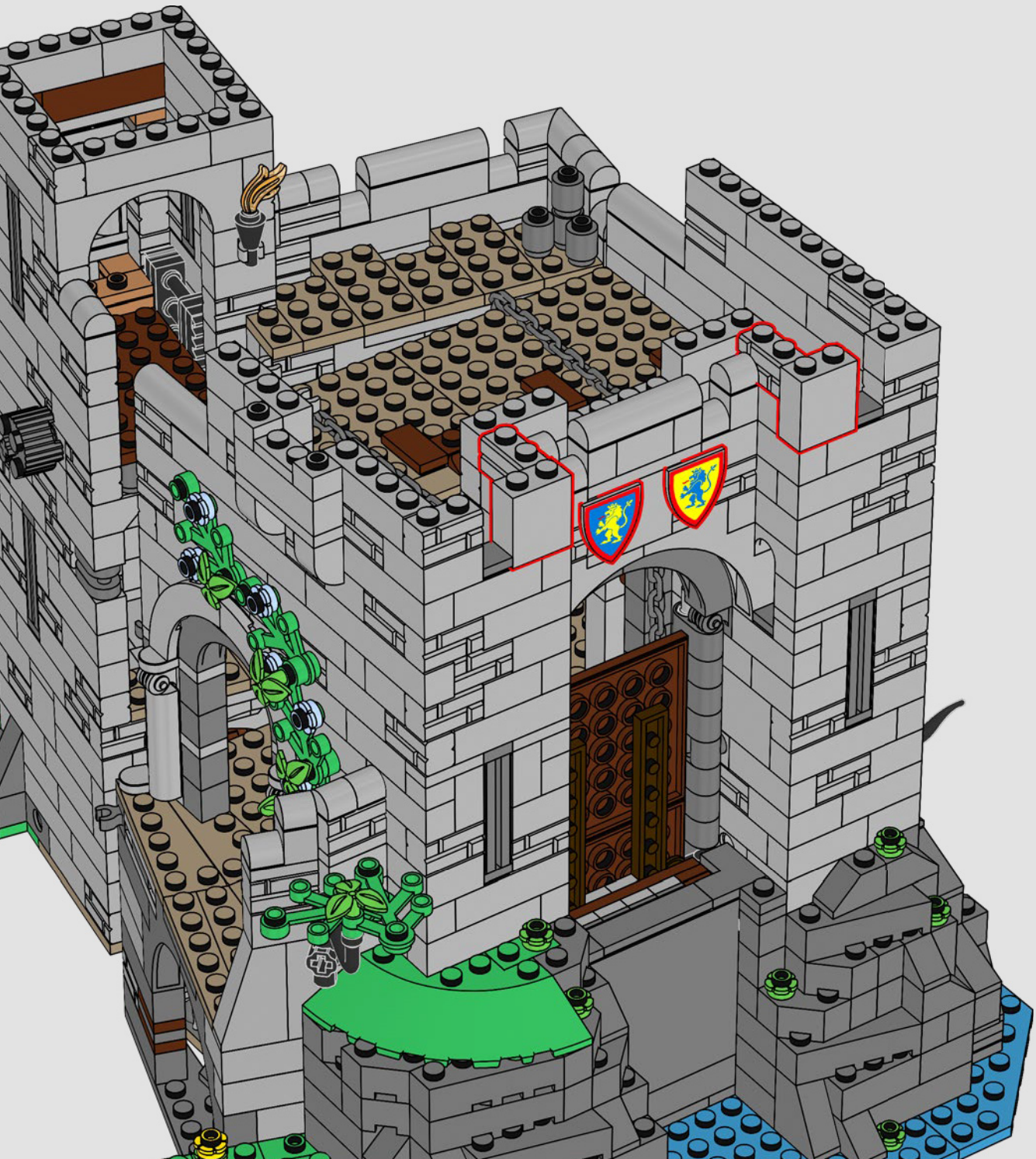

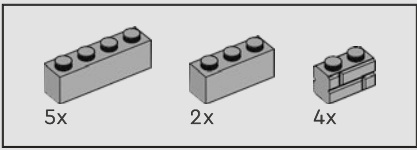

519

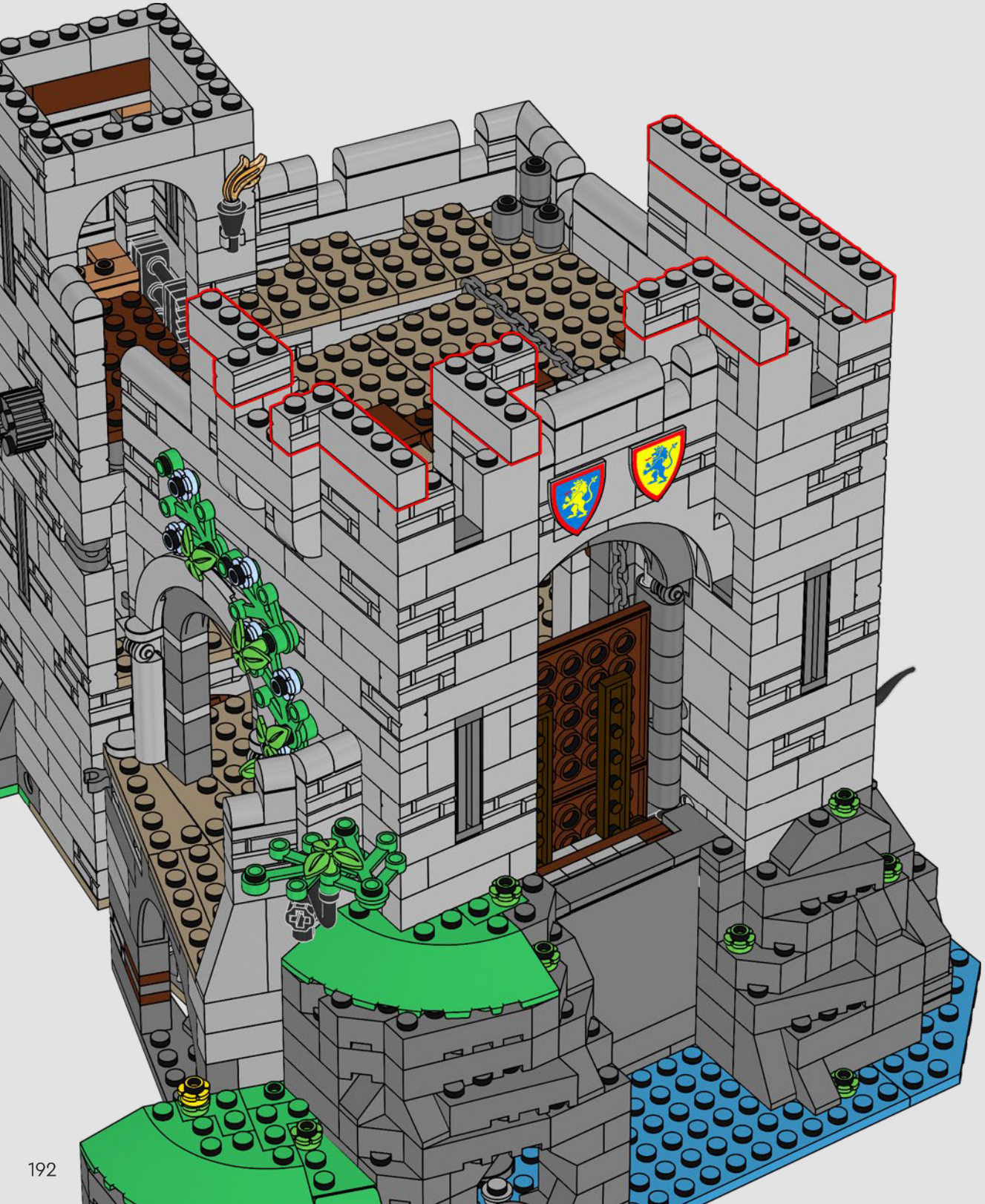

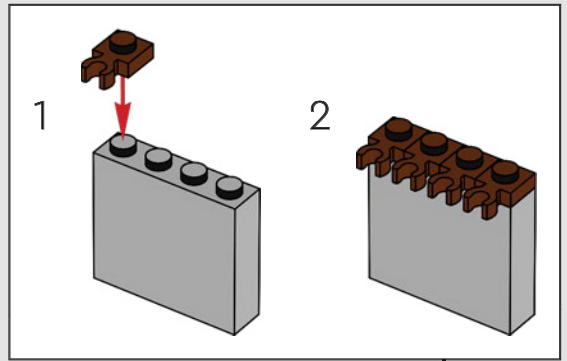
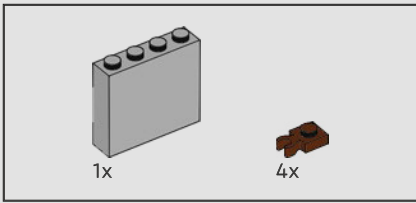

520



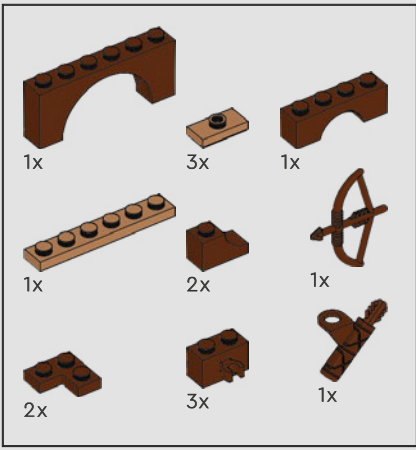

521

1

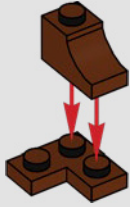

2

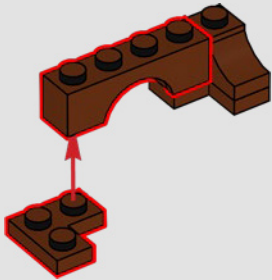

3

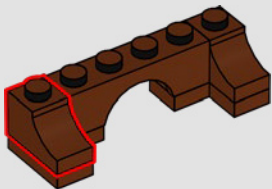

4

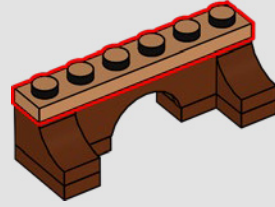

5

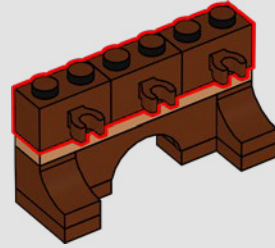

6

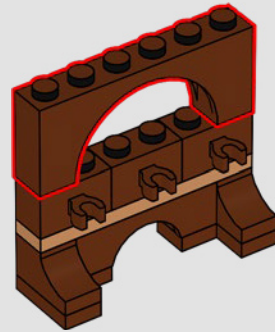

7

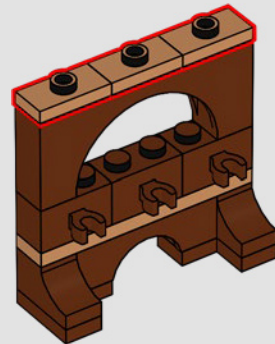

8

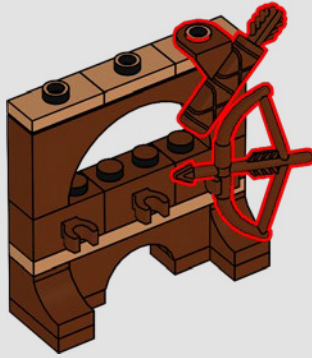

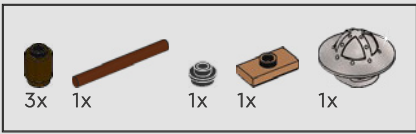

522

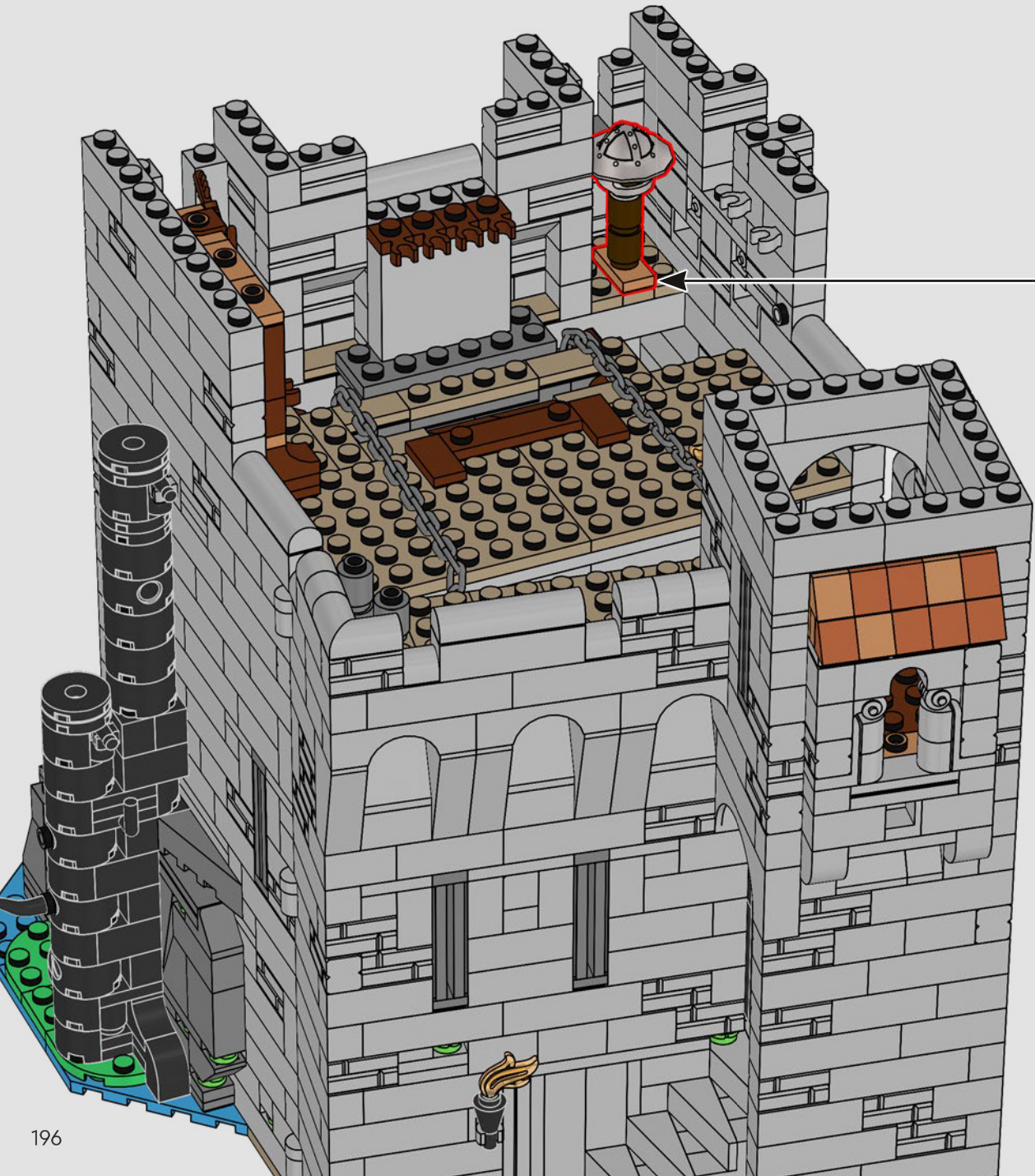
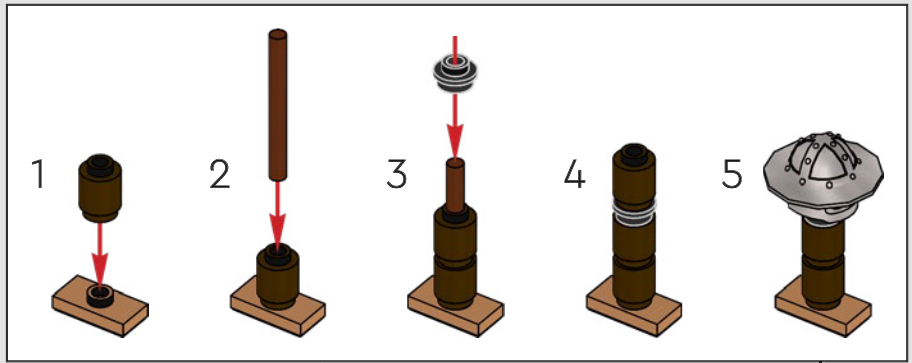

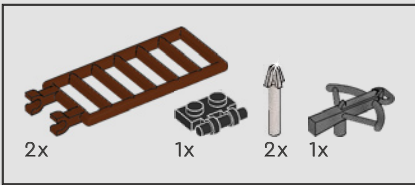

*A perfect armory, plenty of space for weapons!
Now to find a spot for my staff...*

*Une armurerie parfaite, avec beaucoup d'espace
pour les armes ! Maintenant, il faut trouver une
place pour mon bâton...*

*Un almacén de armas perfecto; ¡con mucho
espacio para nuestro arsenal! Ahora necesito un
lugar para poner mi bastón...*

523

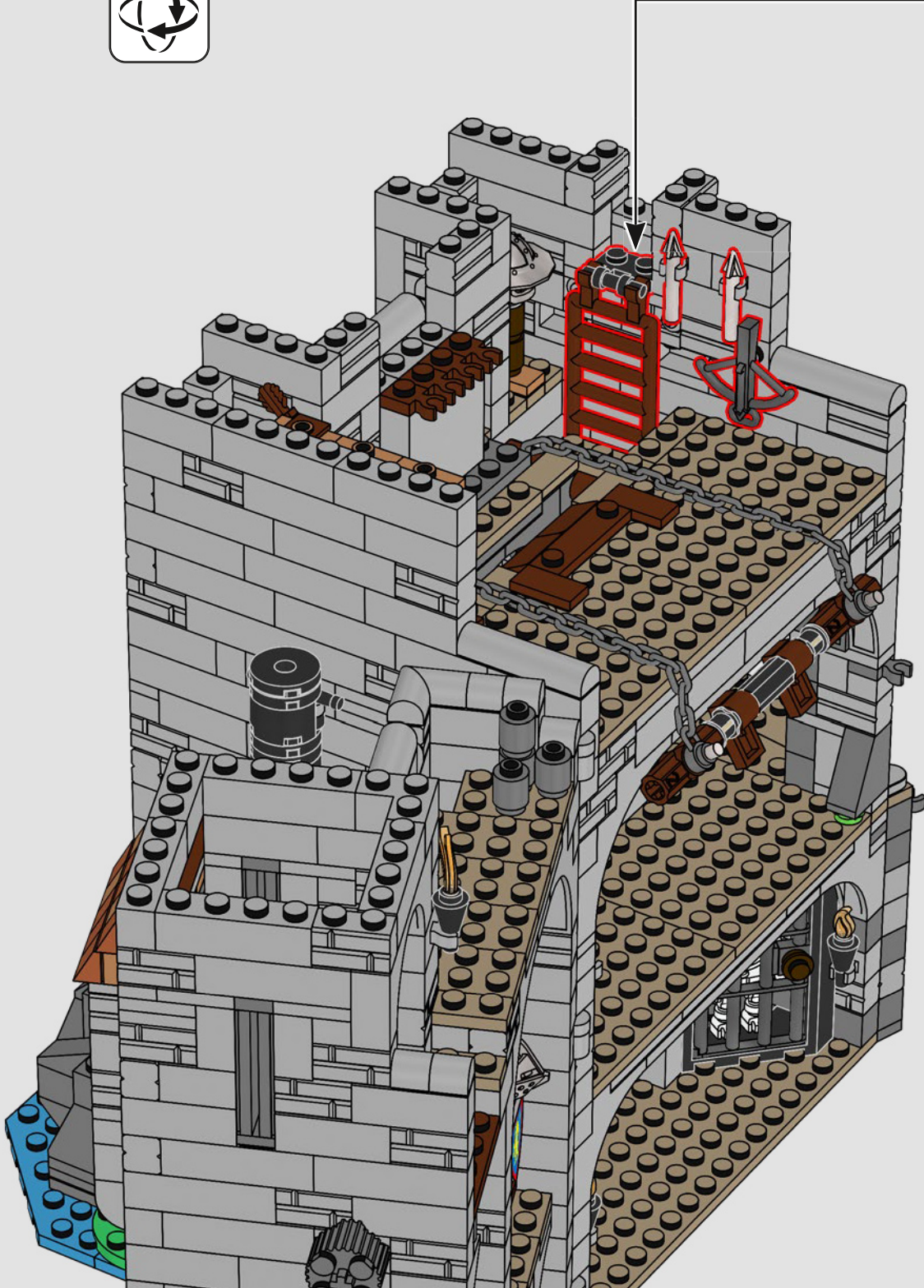
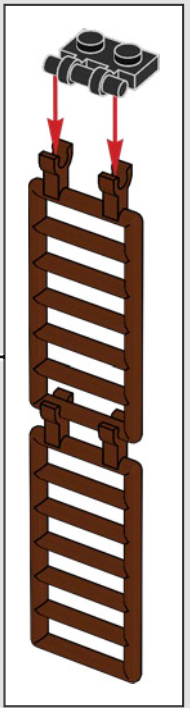

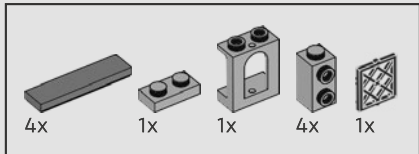

524

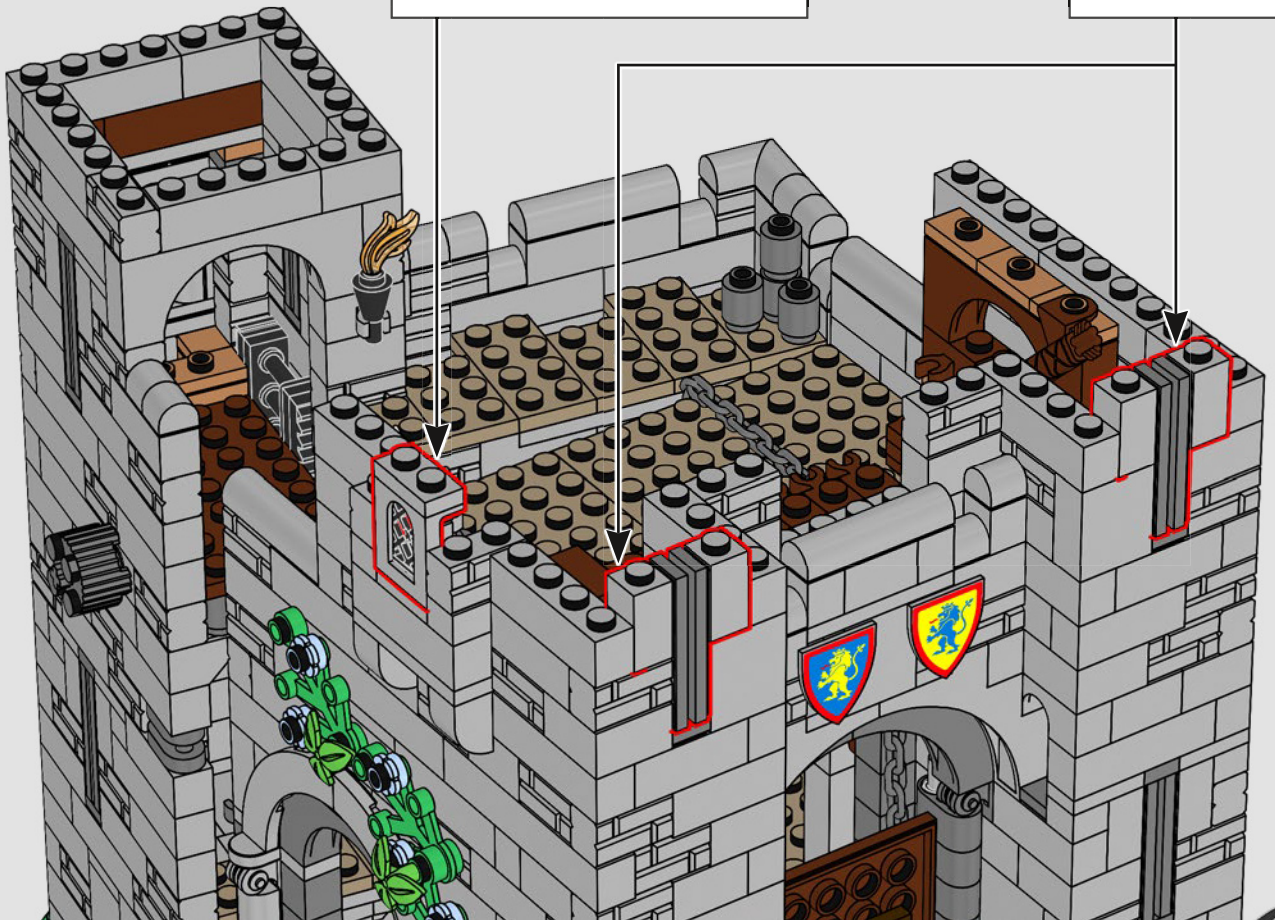
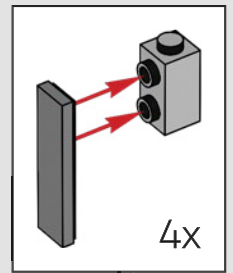
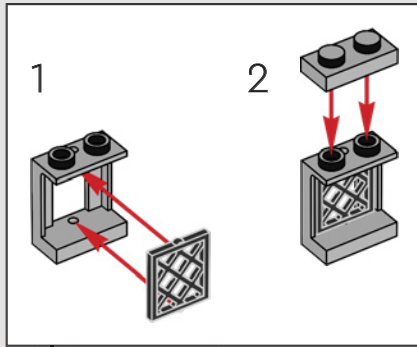

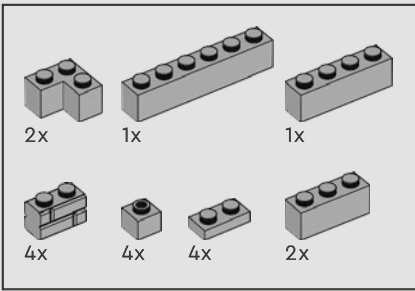

525

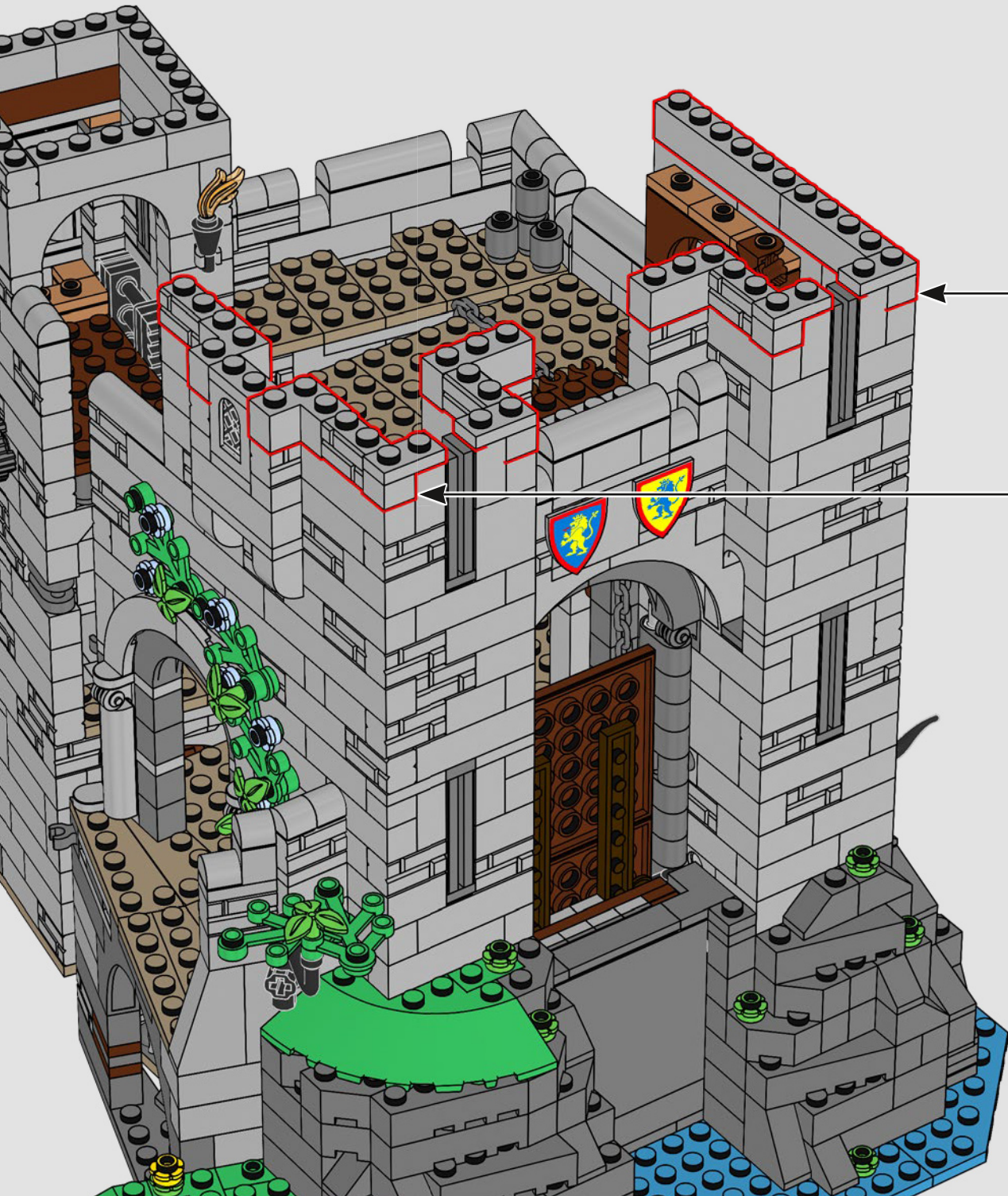
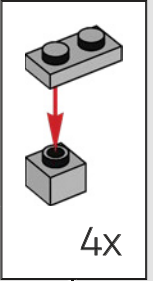

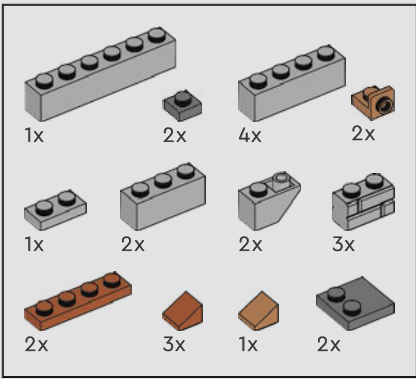

526

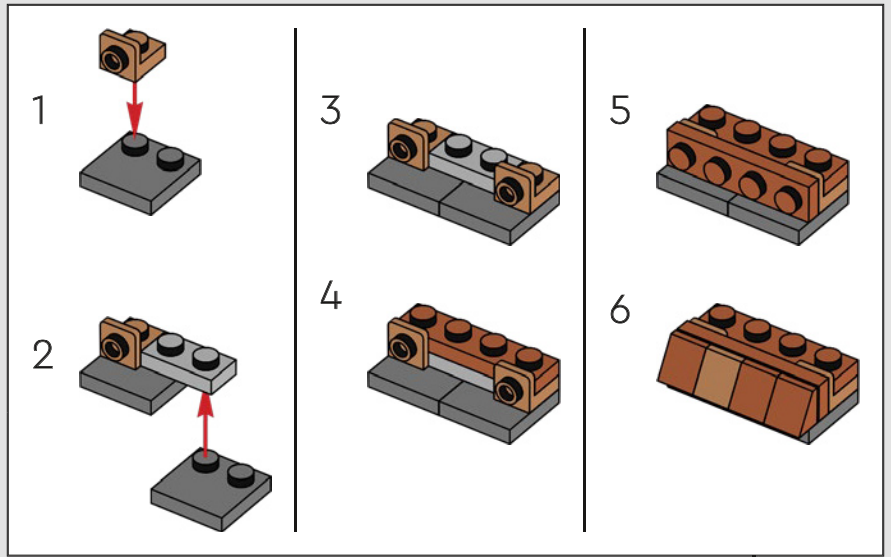

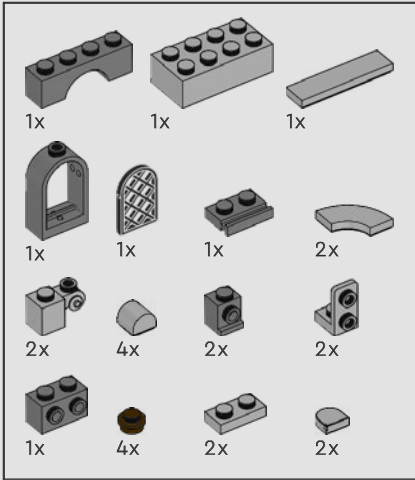
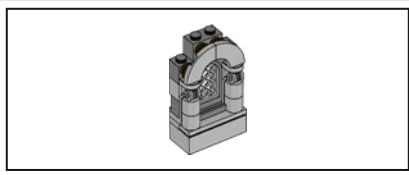

527

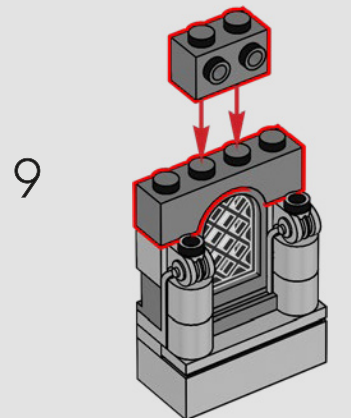
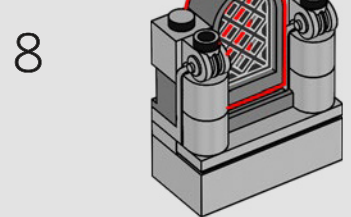
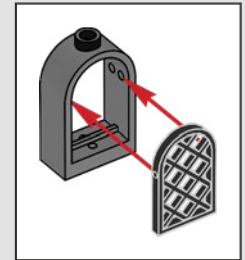
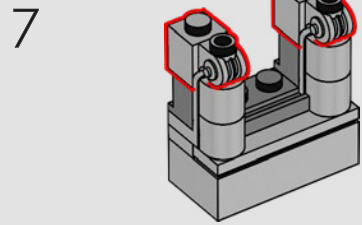
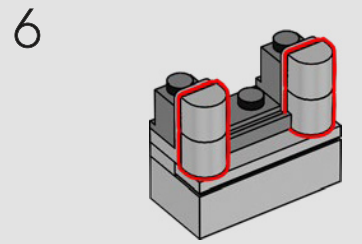
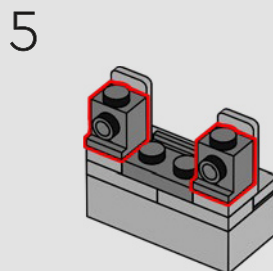
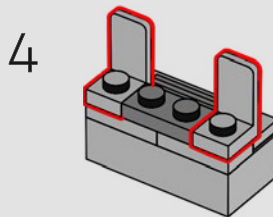
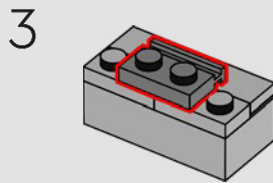
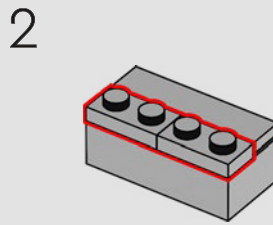
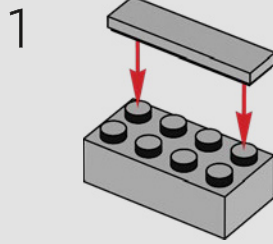

10

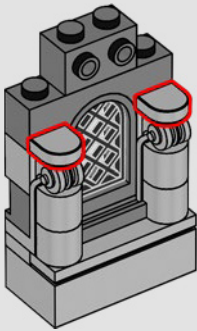

11

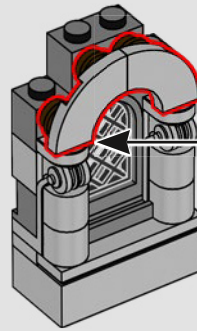

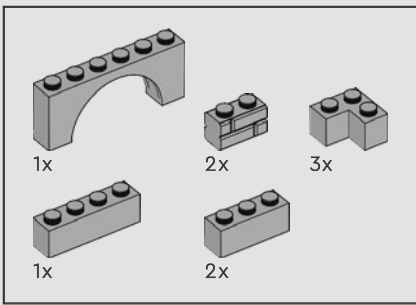

528

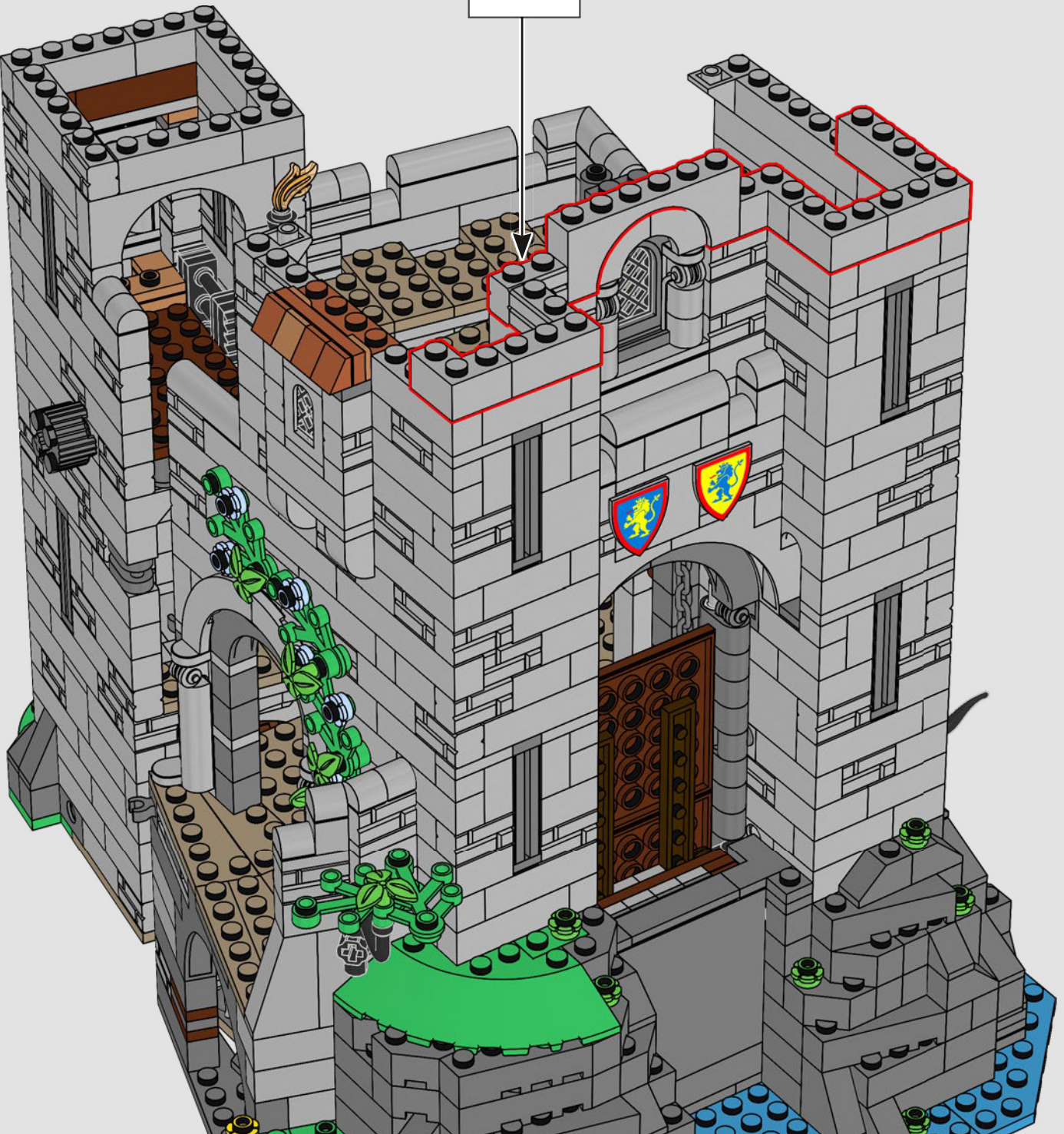
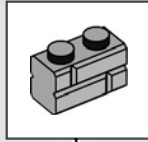

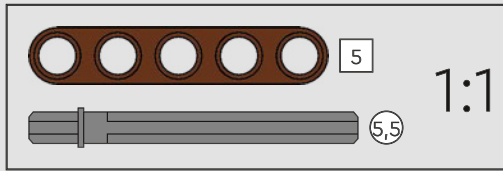
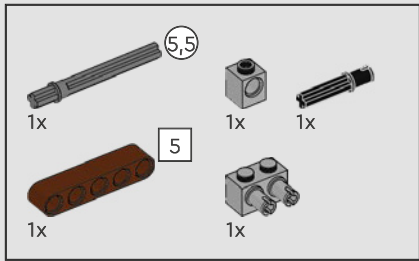

529

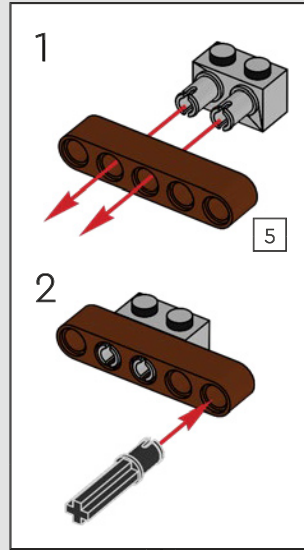
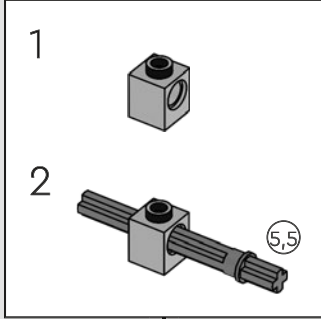

530



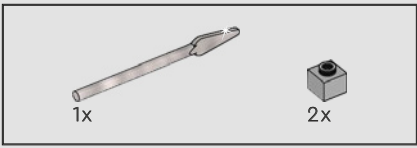

531



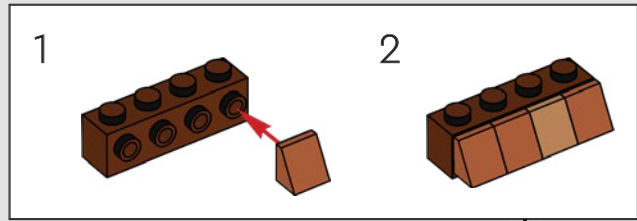
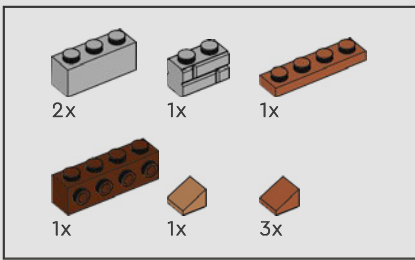

532



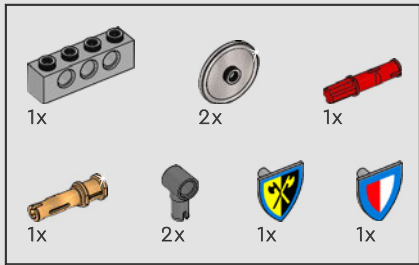

533

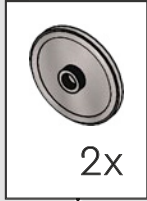
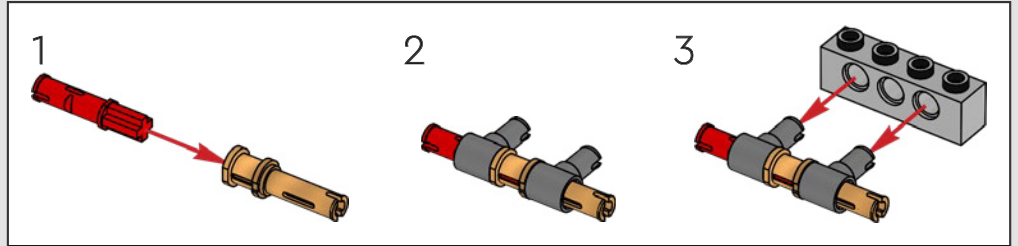

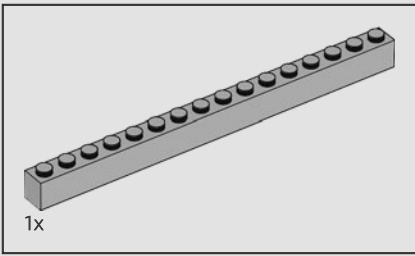

534



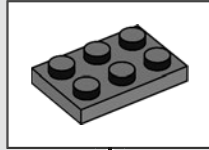
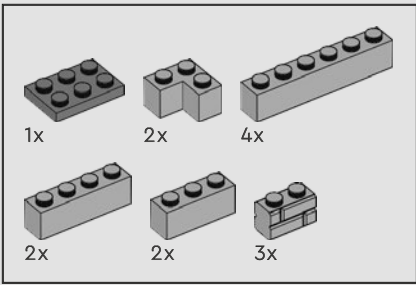

535



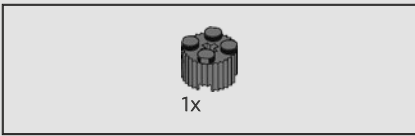

536



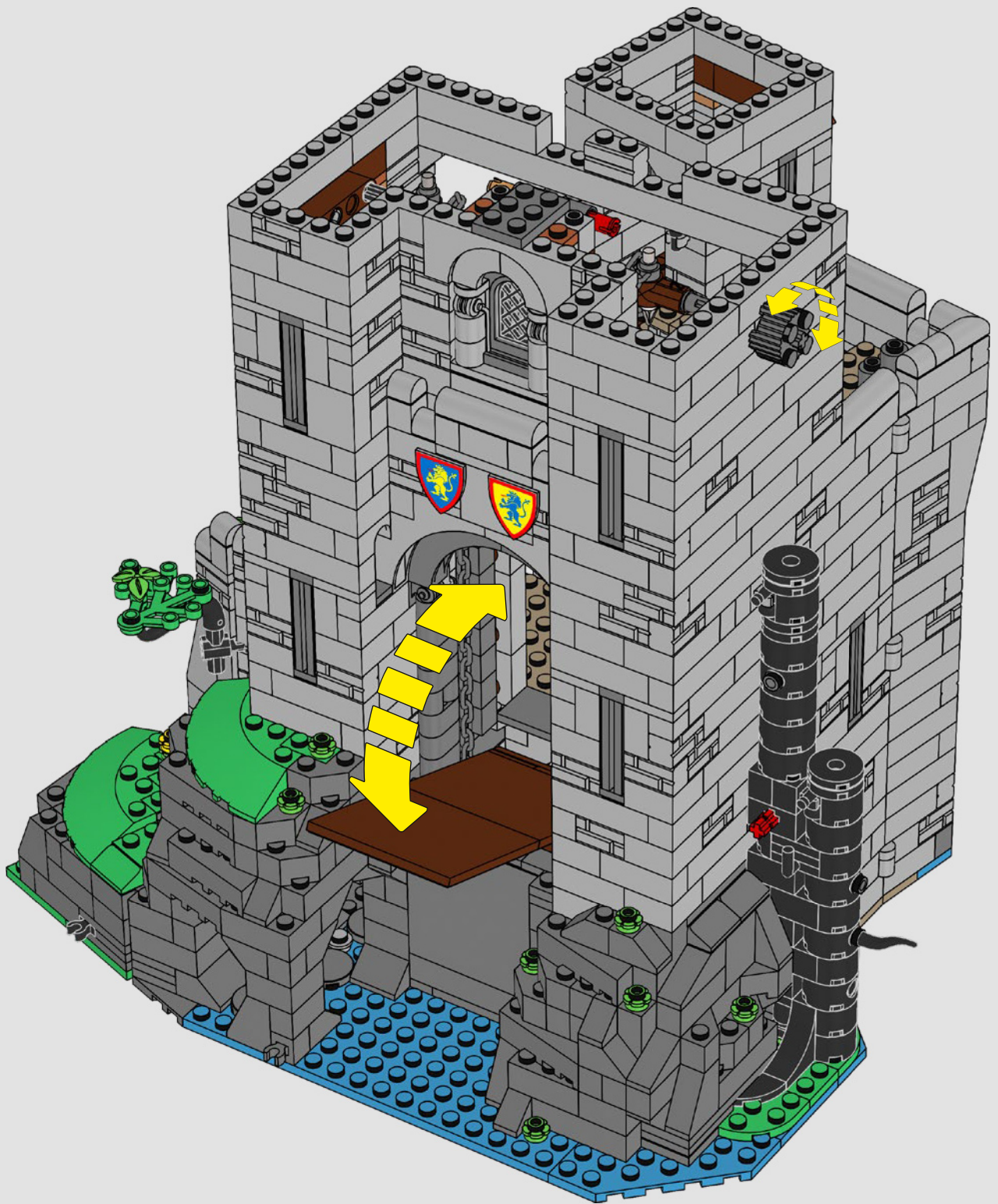



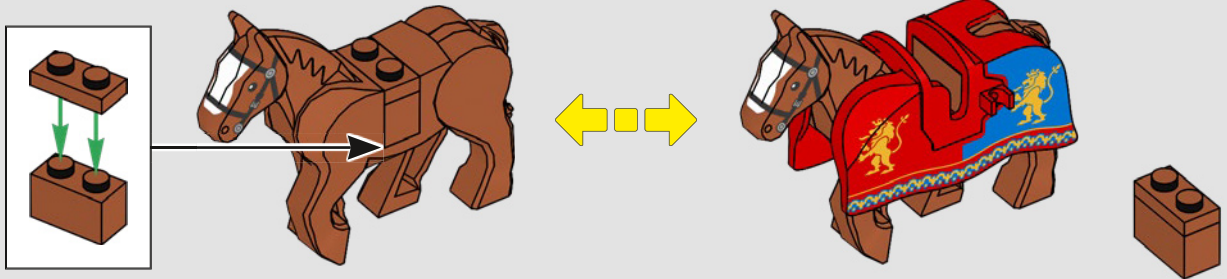
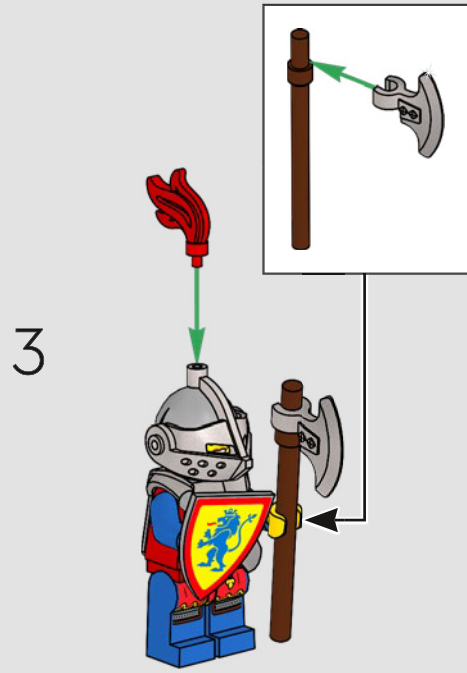
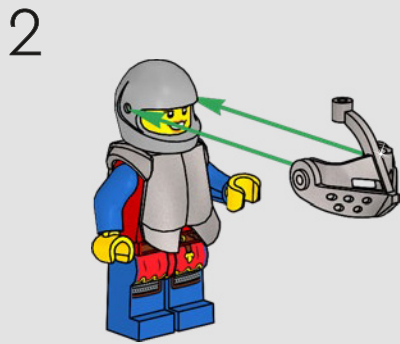
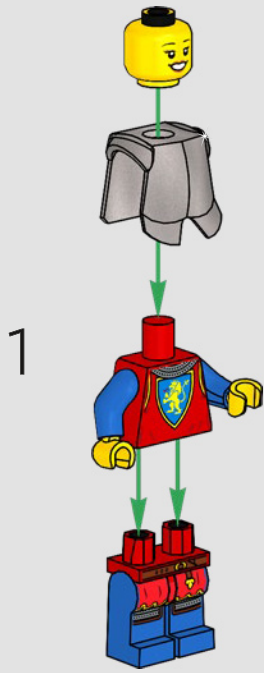

1

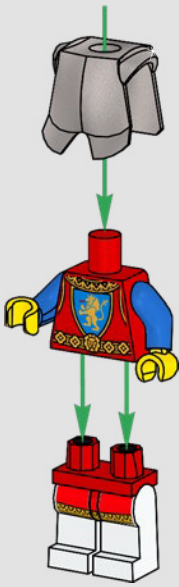

2

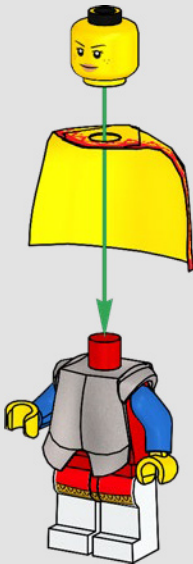

3

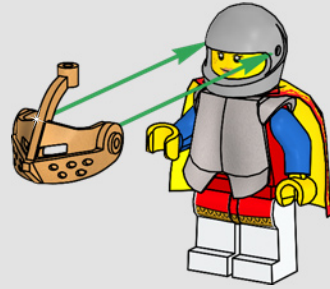

4

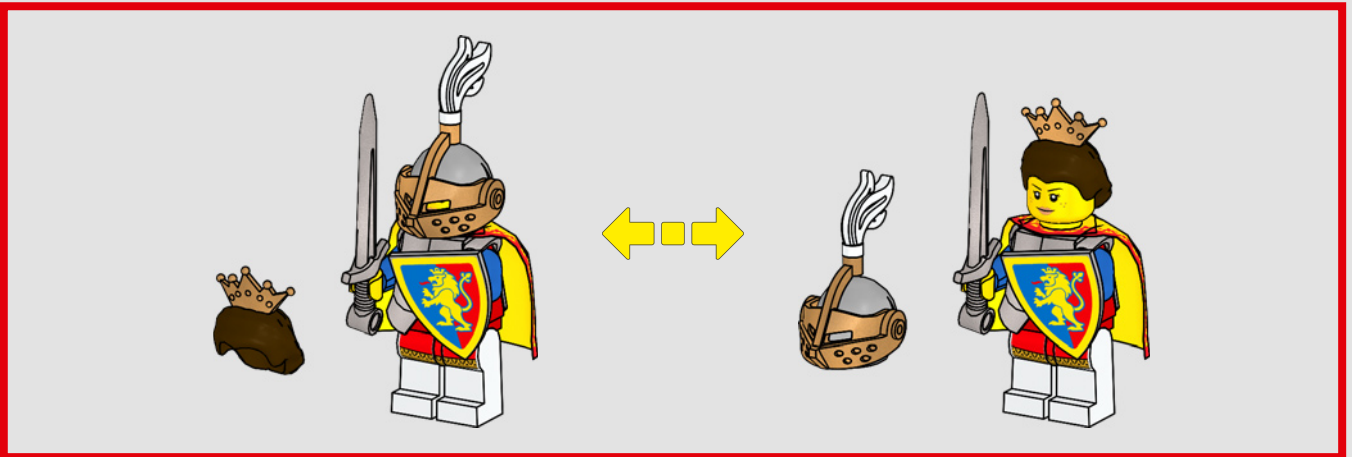
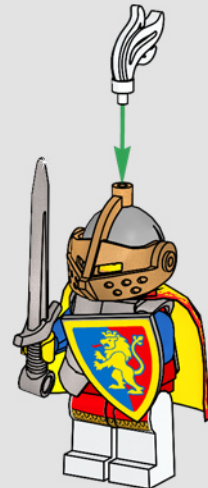

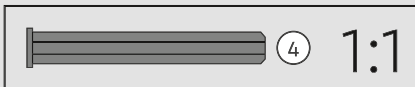
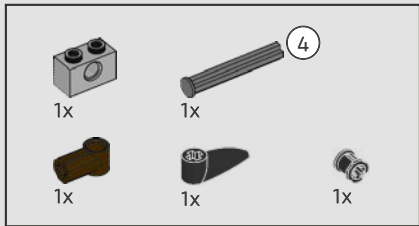

537

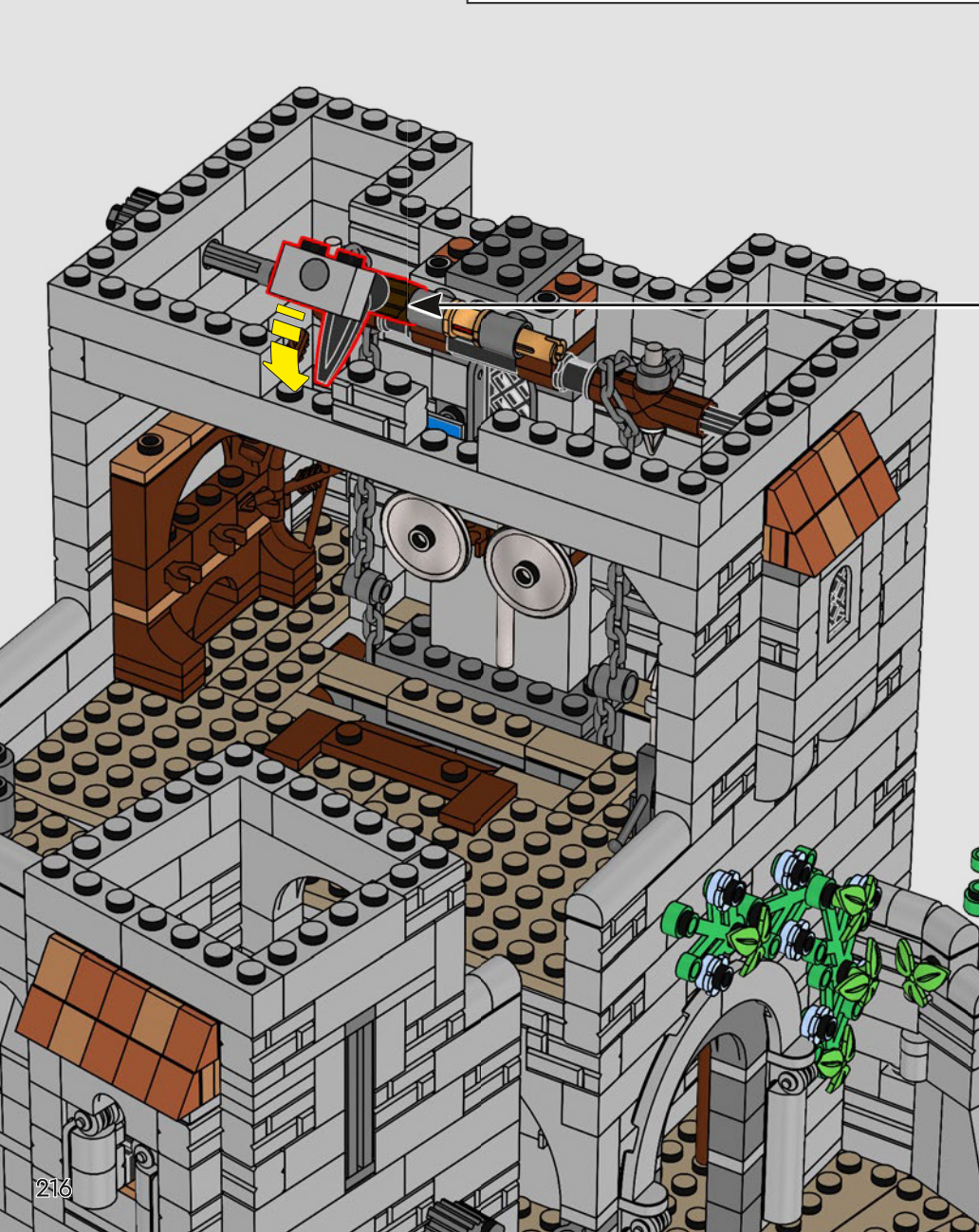
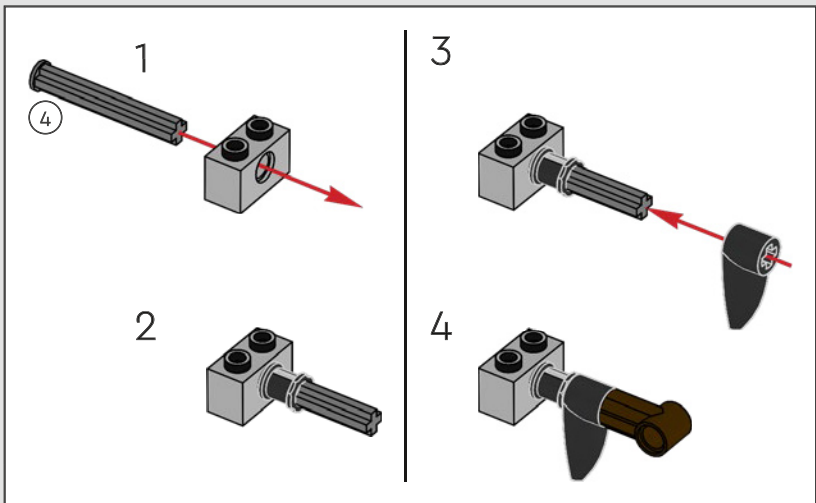

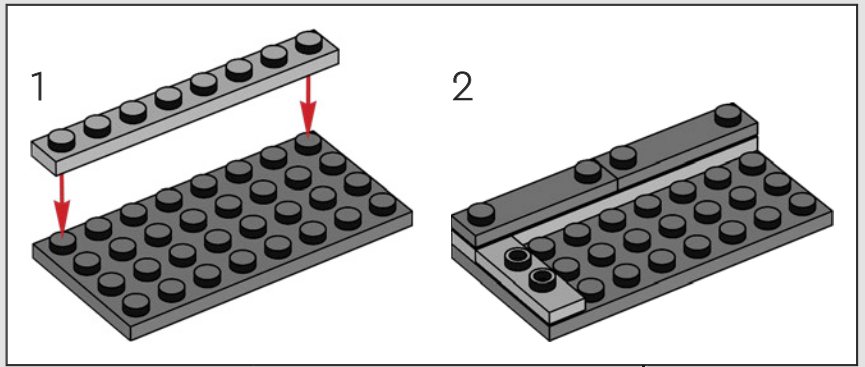
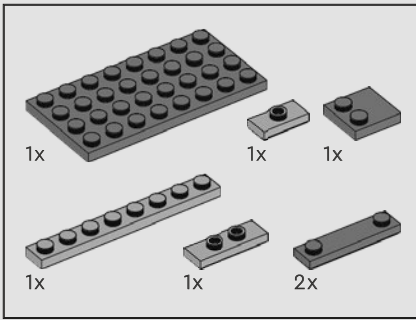

538

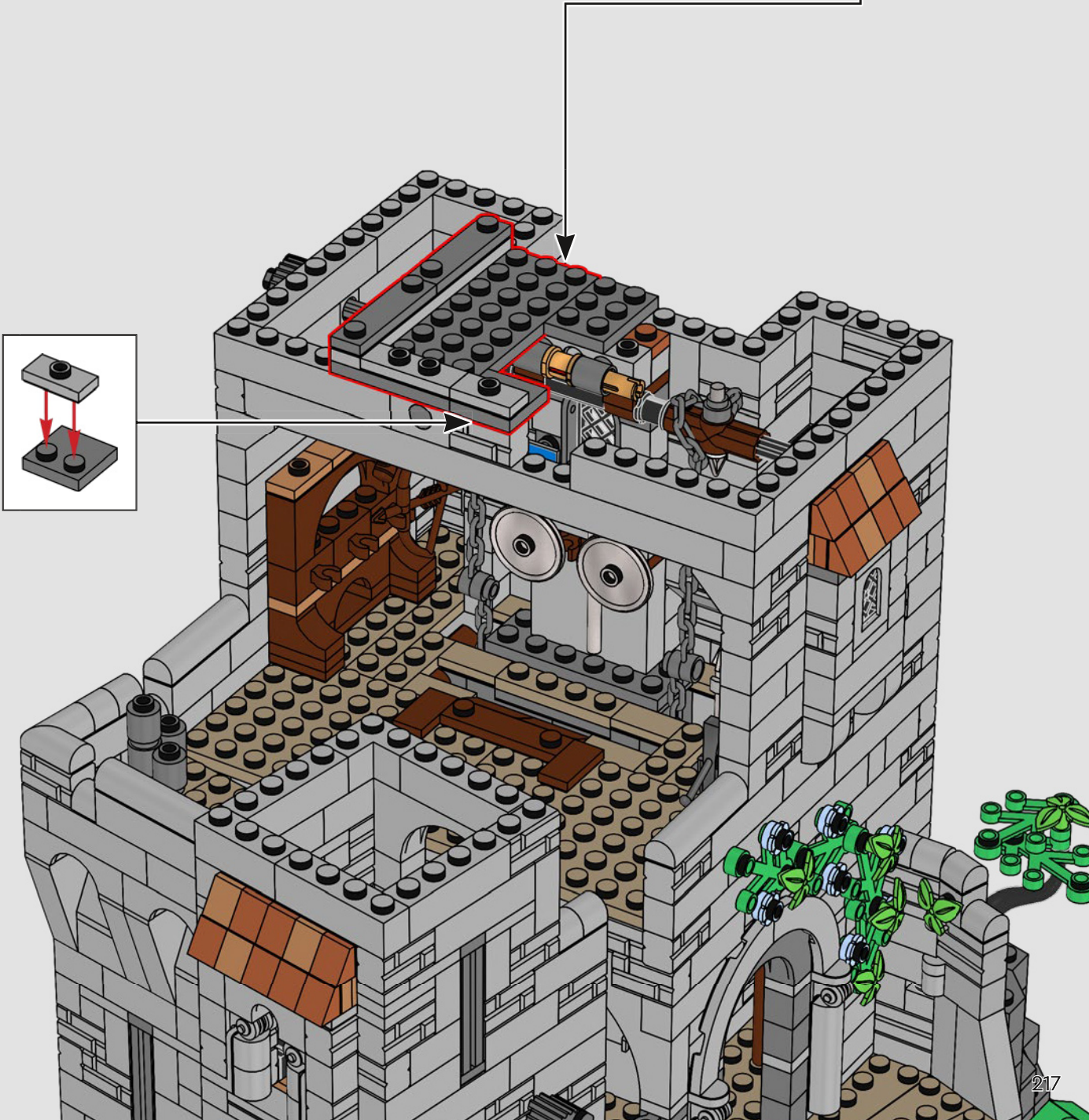

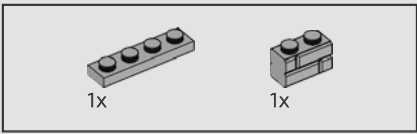

539

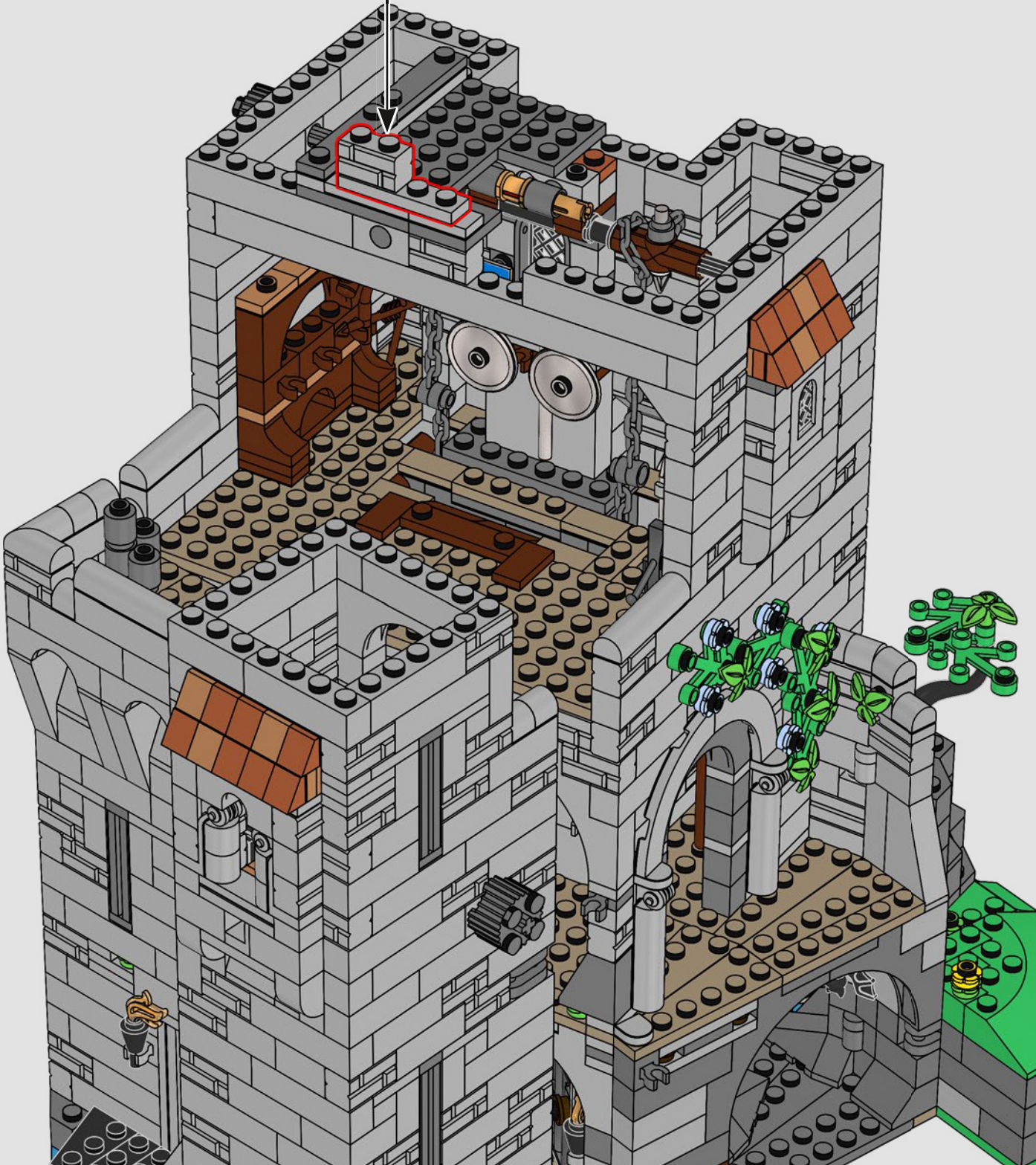
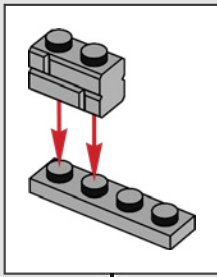

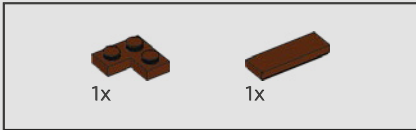
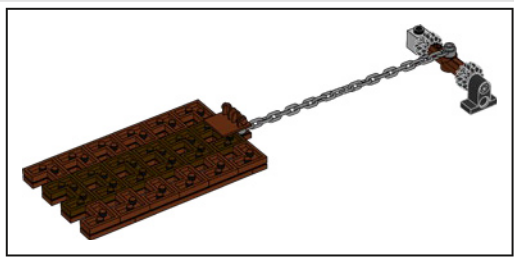

540

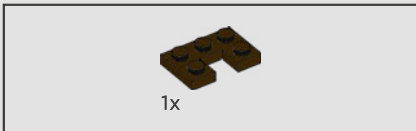
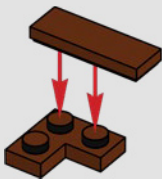

541

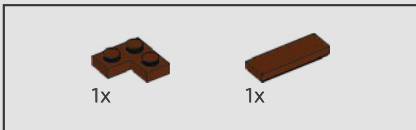
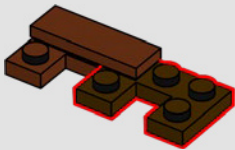

542

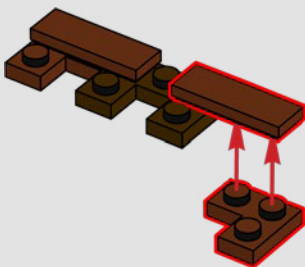

543

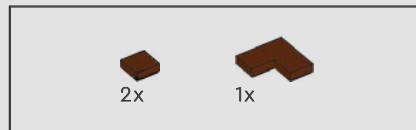
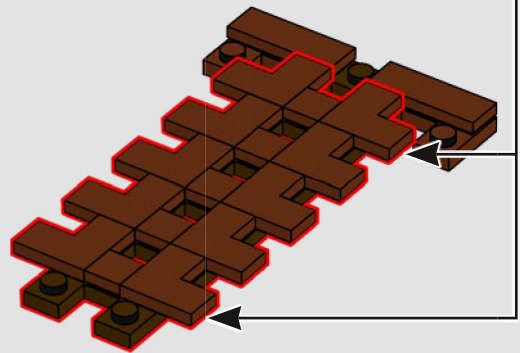
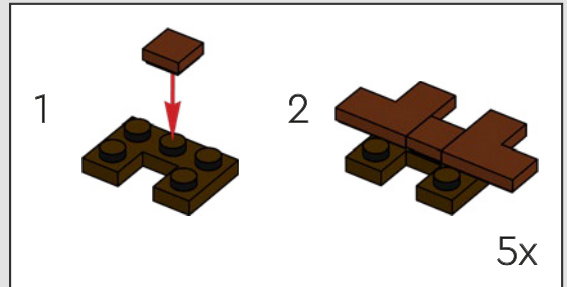

544

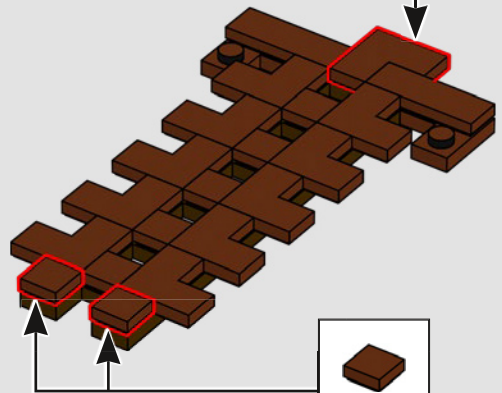
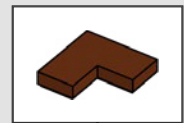

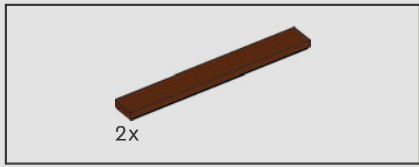

545

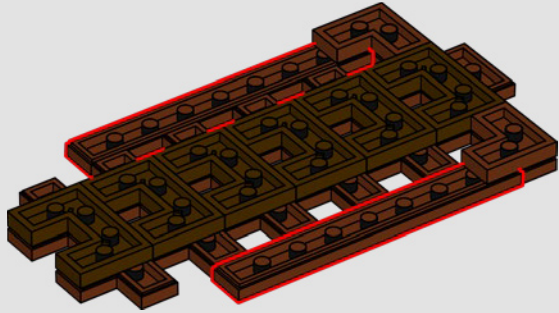

546

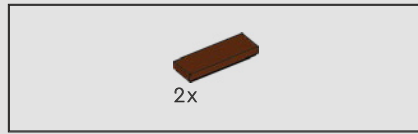
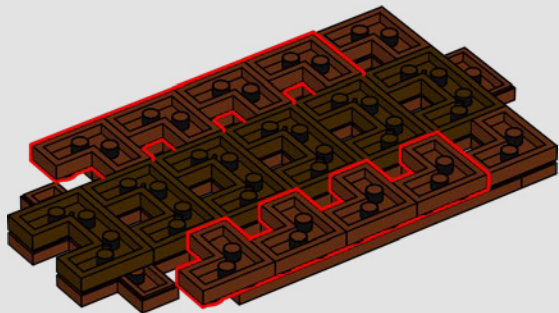

547

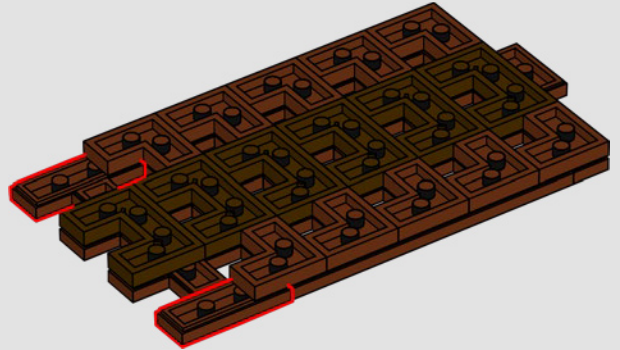

548

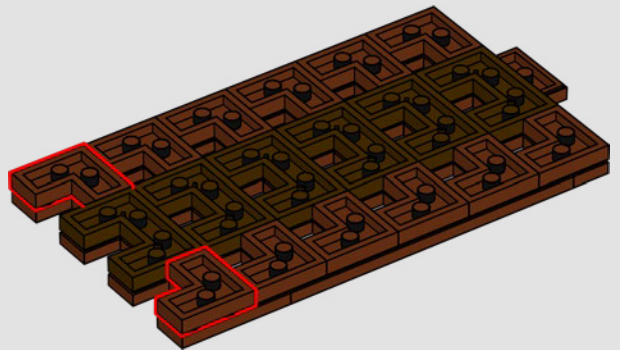

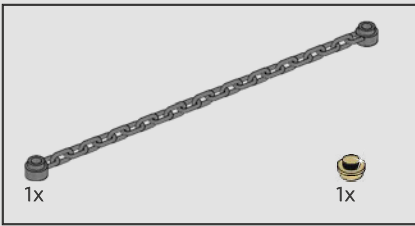

549

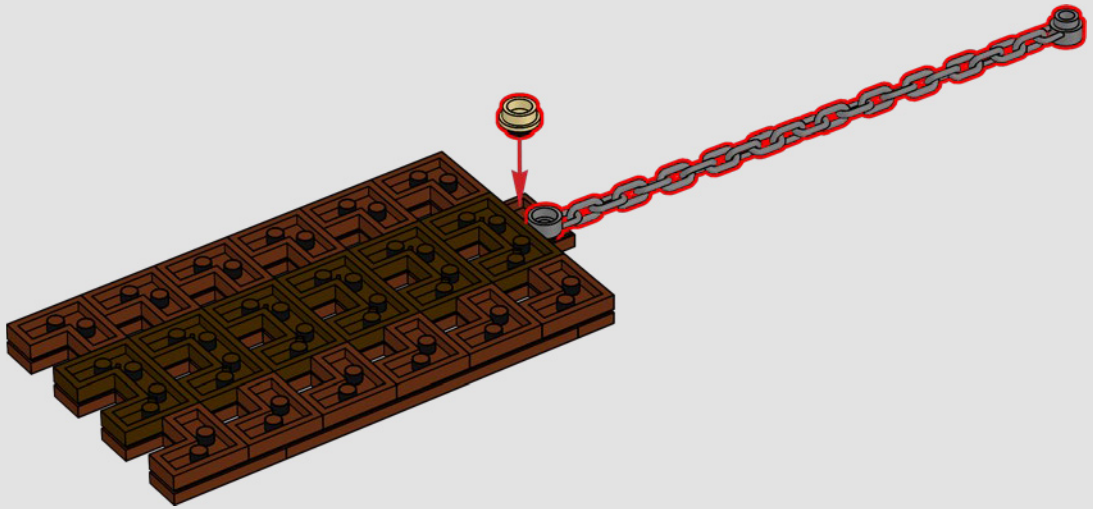

550

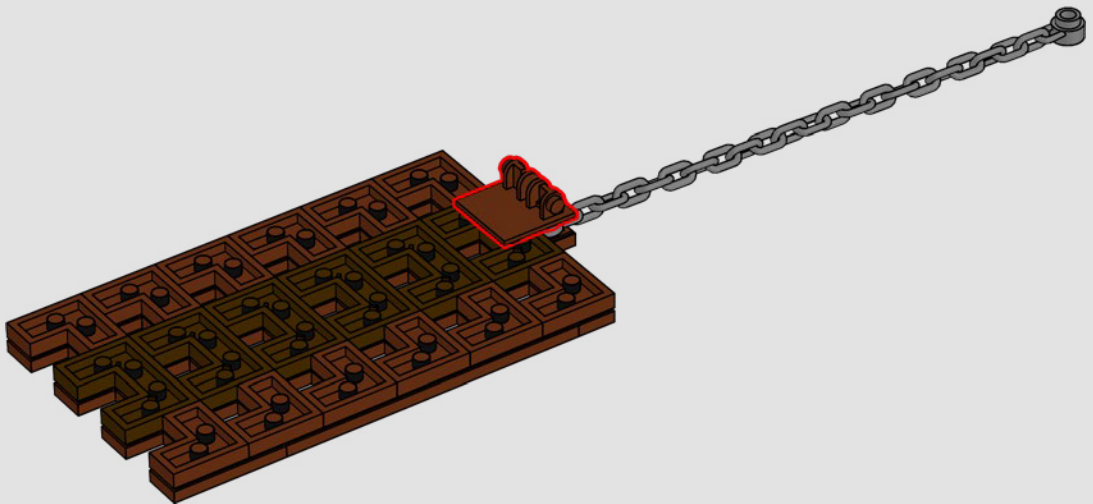

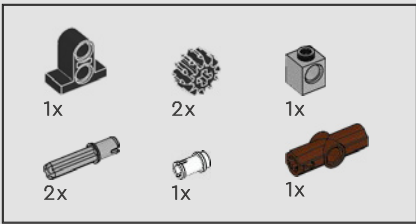

551

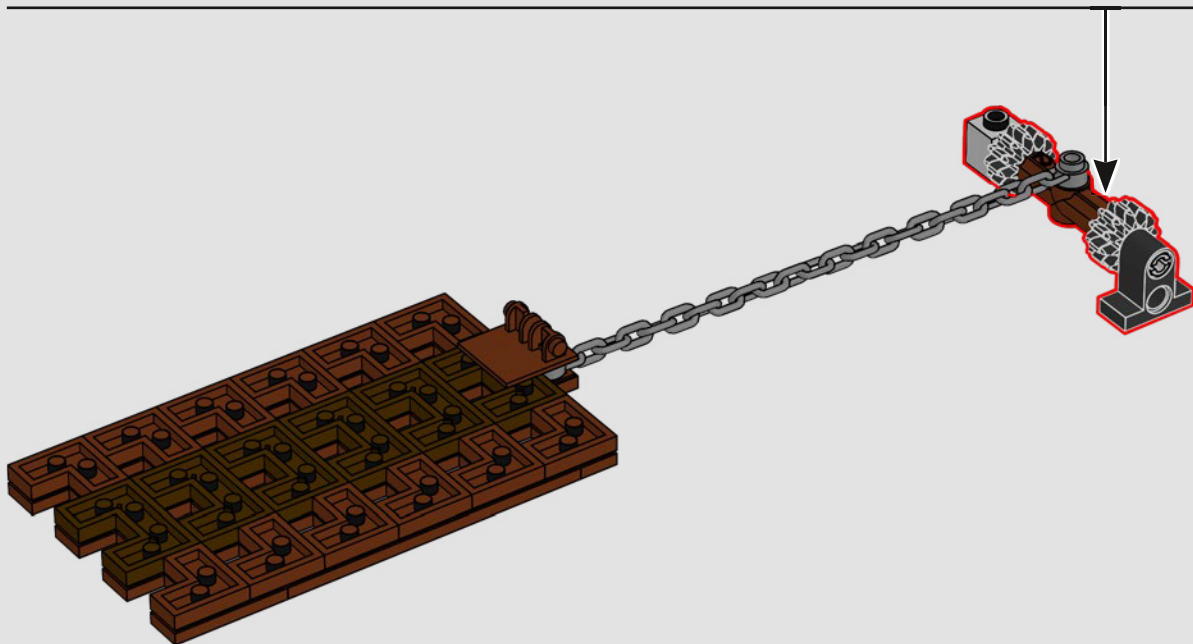
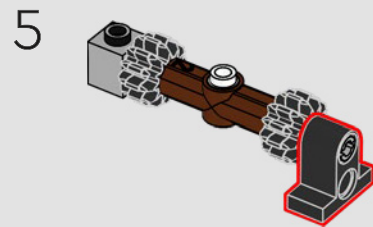
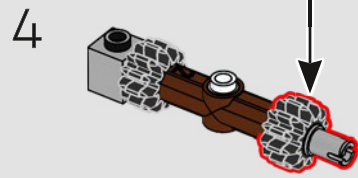
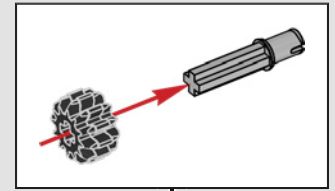
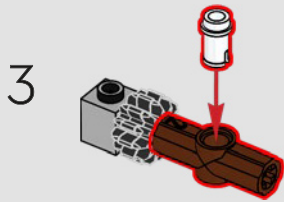
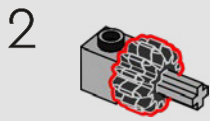
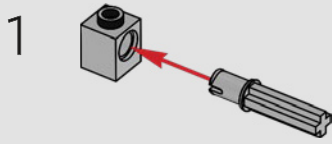



*Such a heavy portcullis! Should do nicely to protect
our front gate in times of trouble!*

*Cette herse est si lourde ! Elle devrait bien défendre
notre porte d'entrée en cas de problème !*

*¡Qué rastrillo tan pesado! Protegerá bien nuestra
entrada principal en tiempos difíciles.*

552





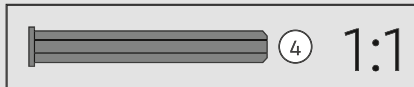
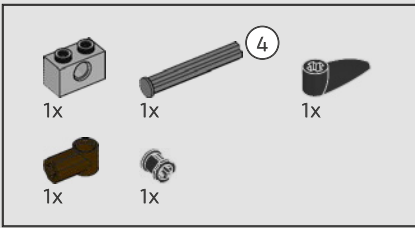

554

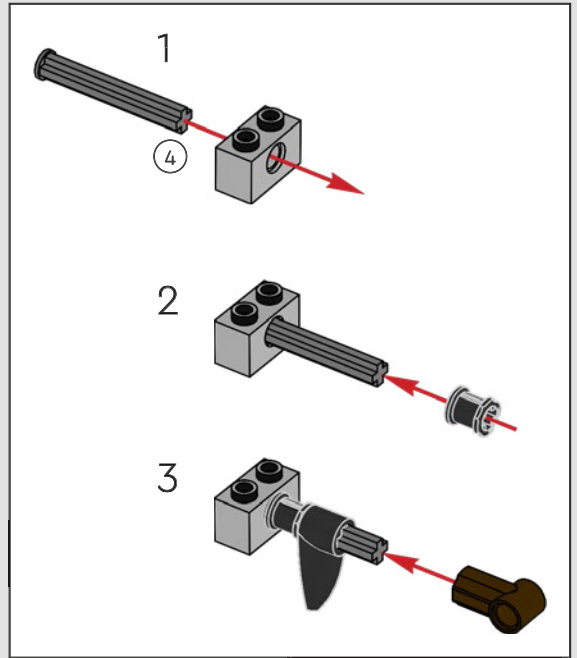

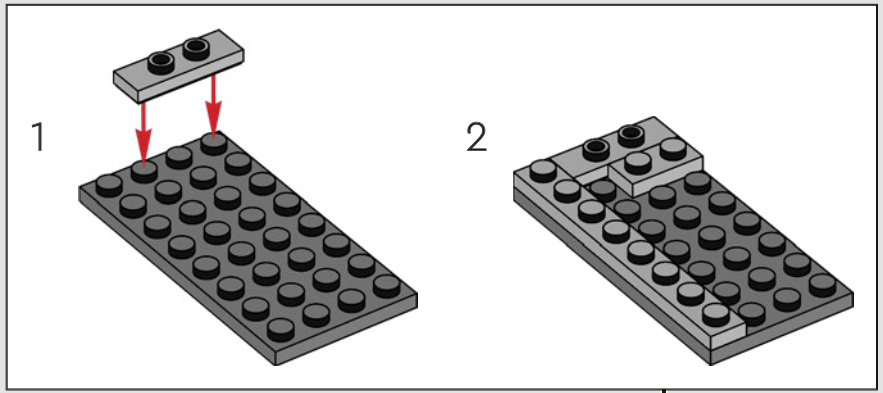
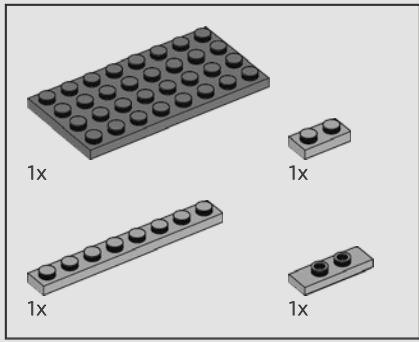

555

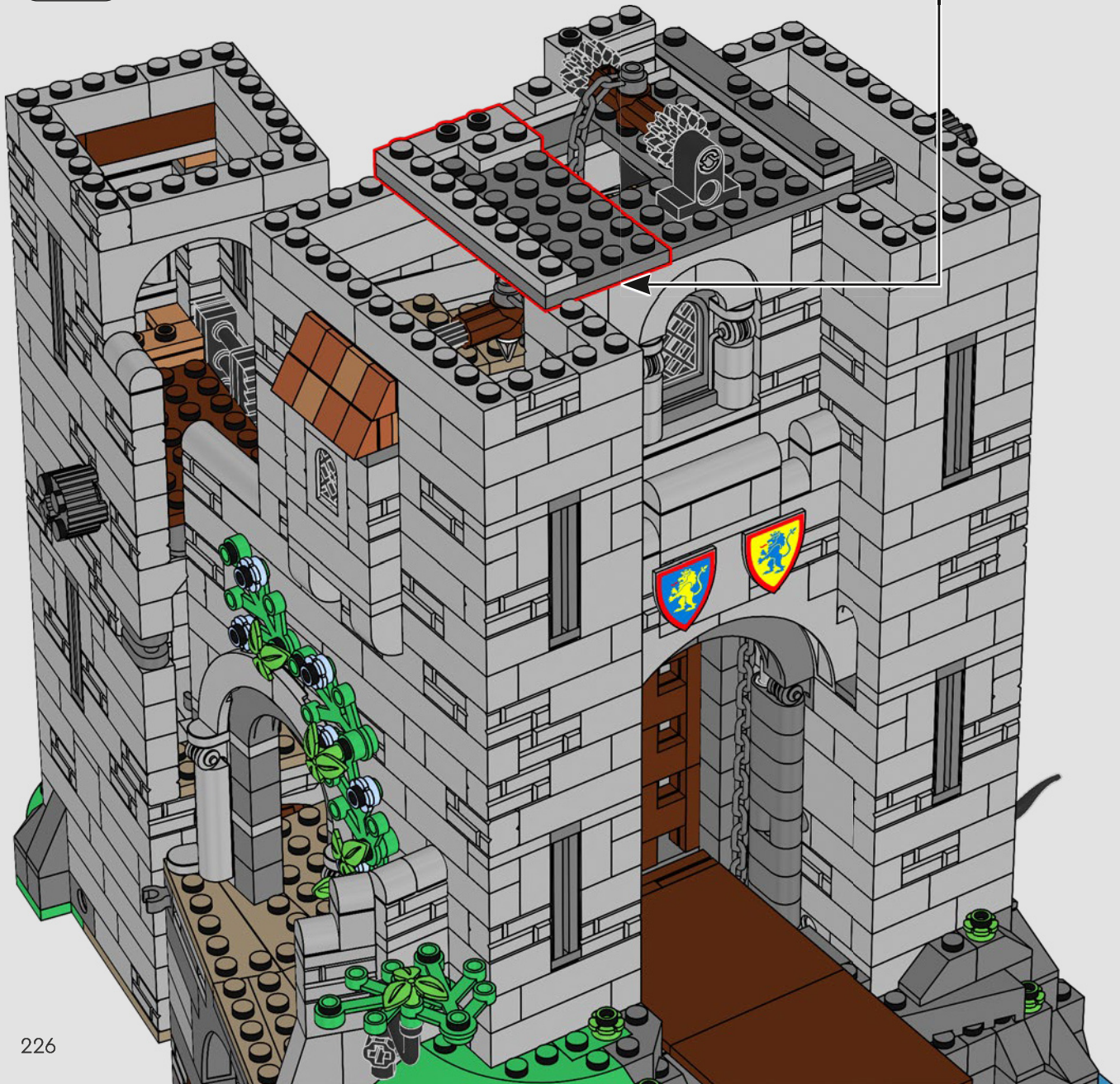

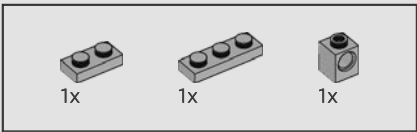

556

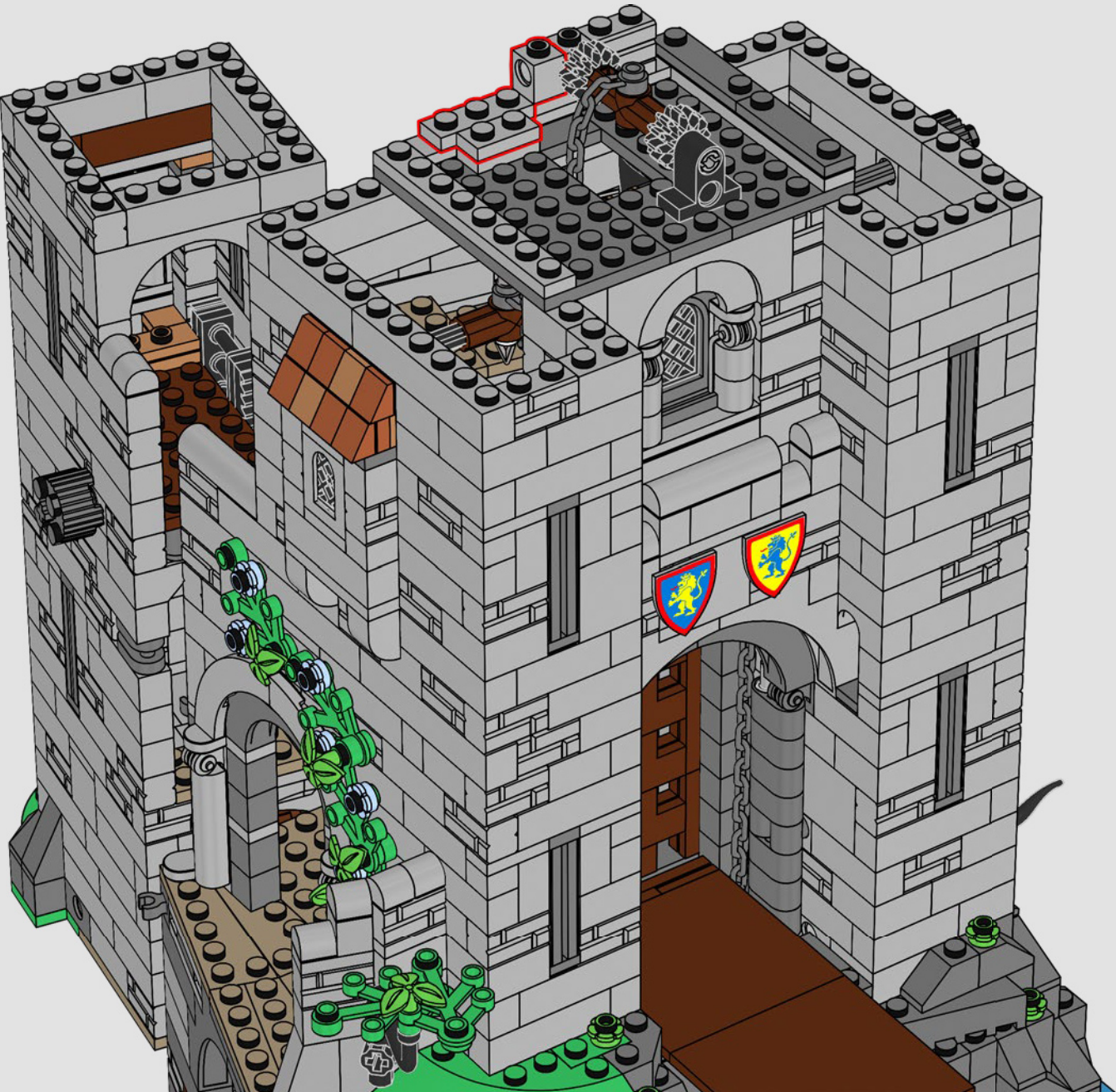

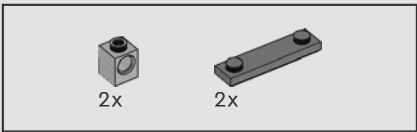

557

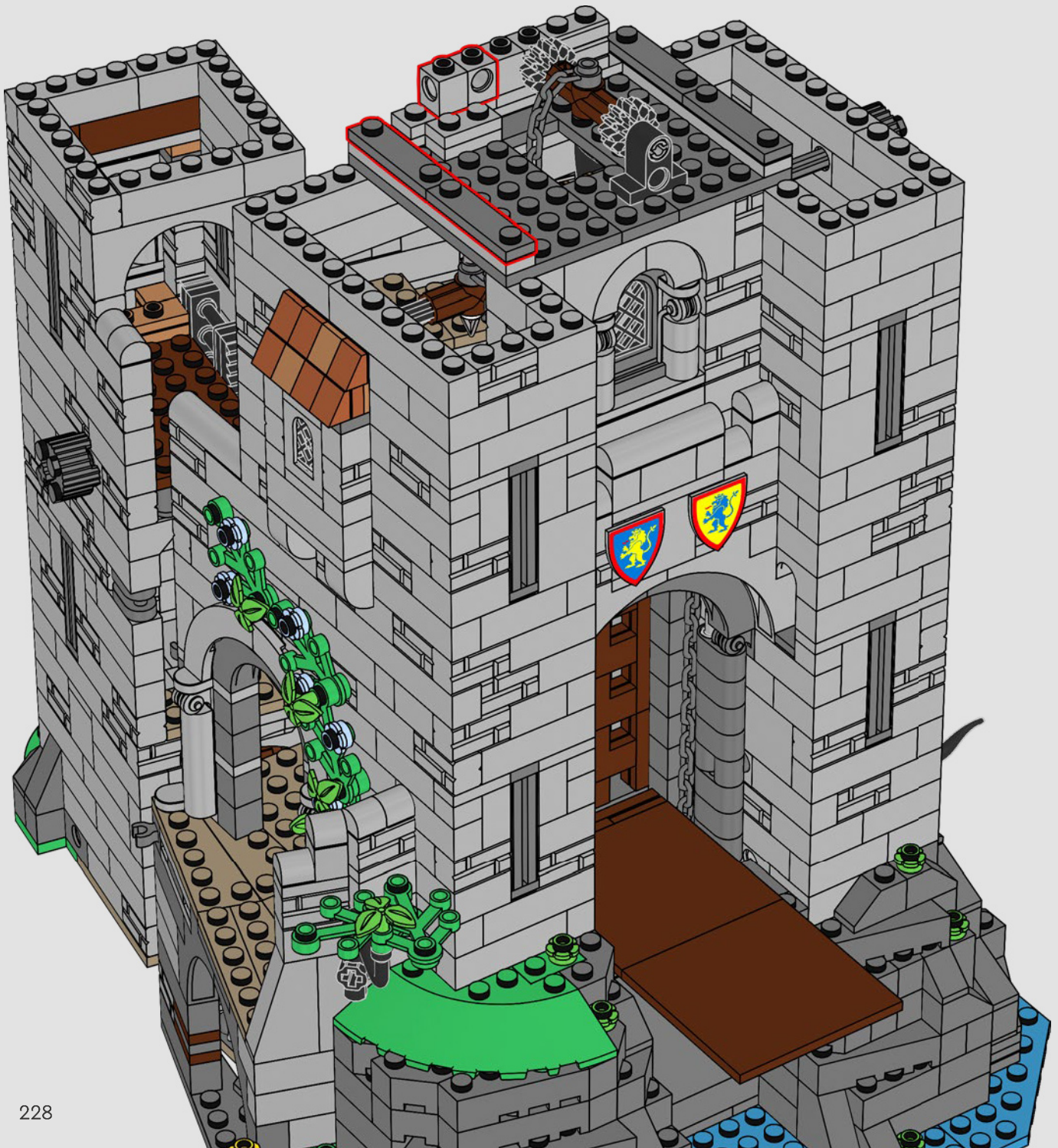

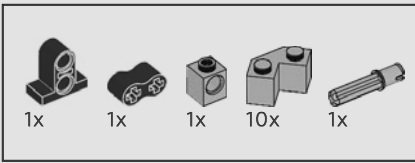

558

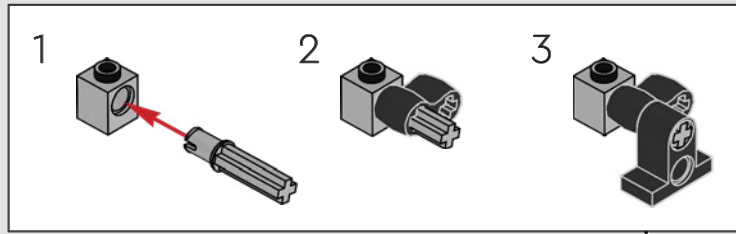

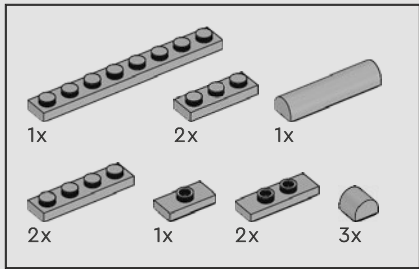

559

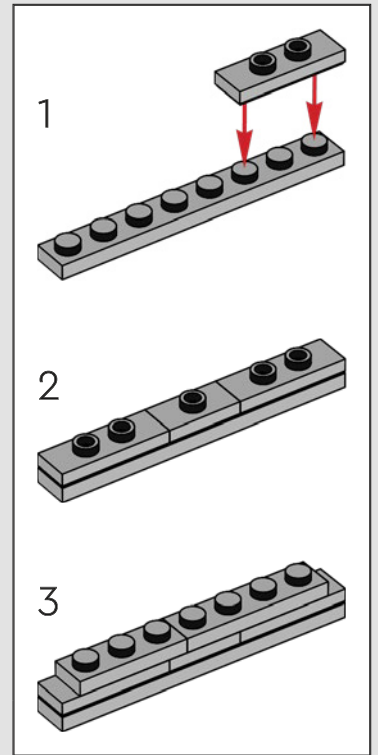
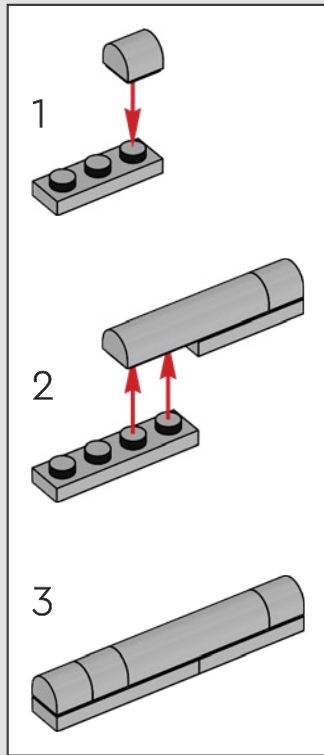

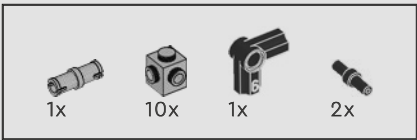

560

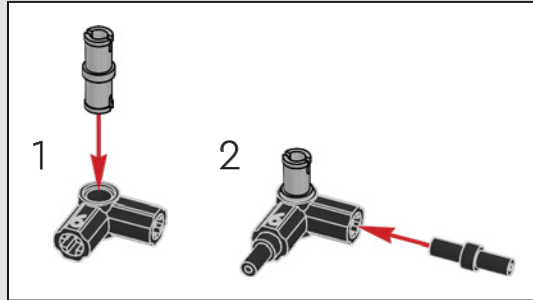







3x



I wonder what this lever does...

Je me demande ce que fait ce levier...

Me pregunto qué hace esta palanca...

561

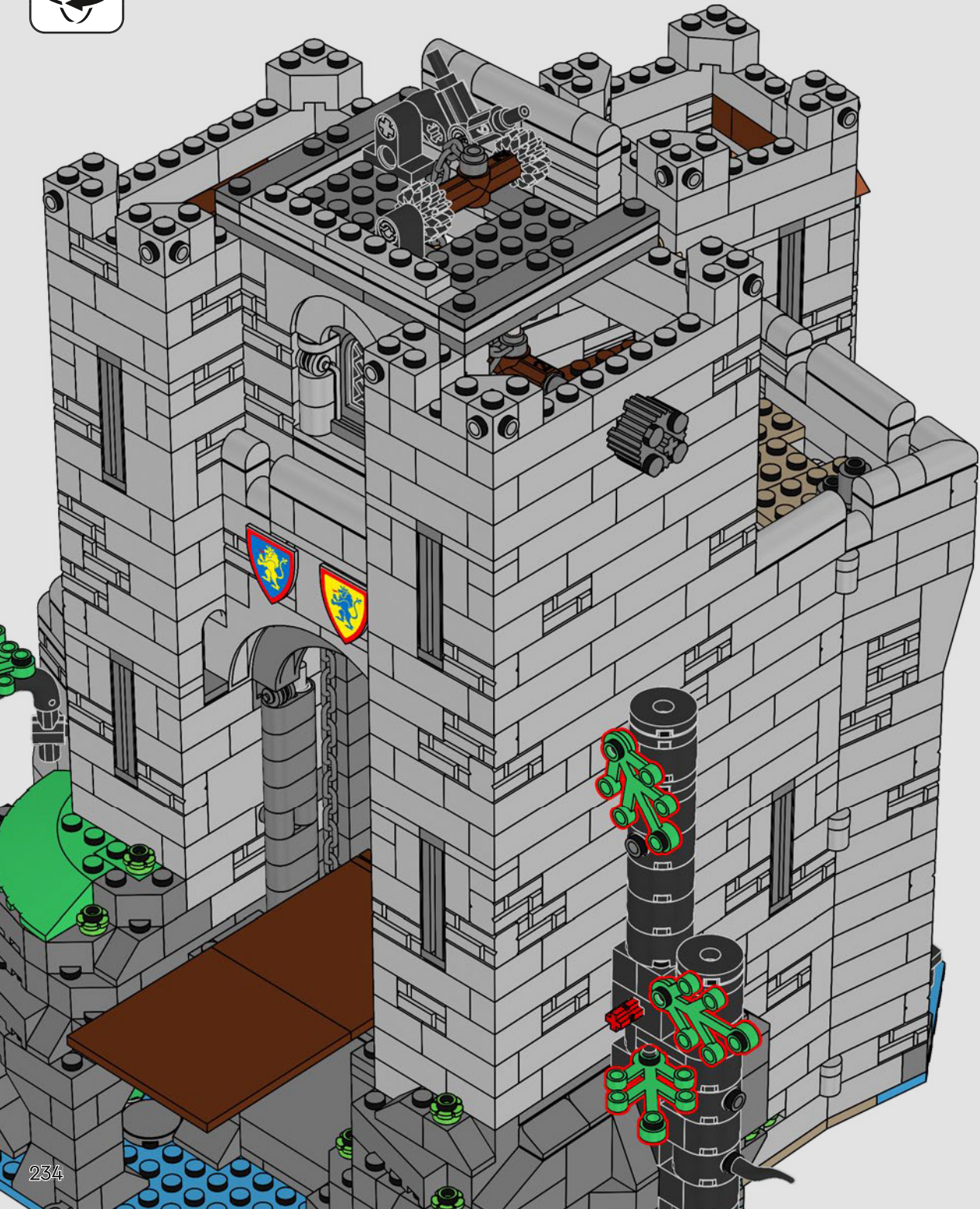

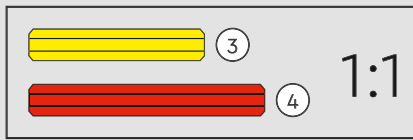
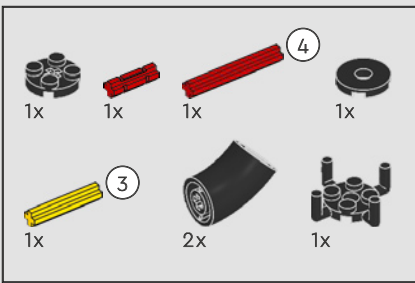

562

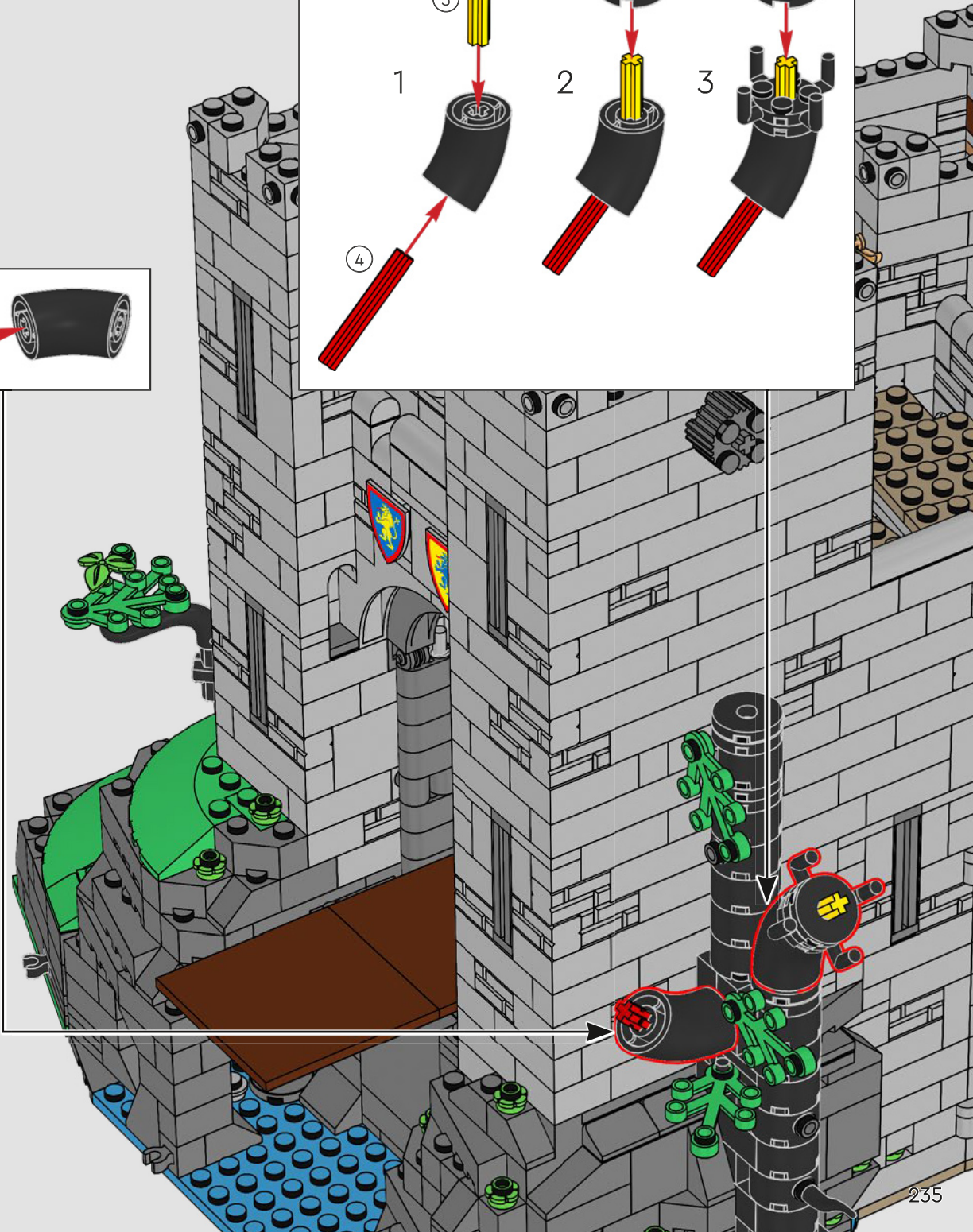
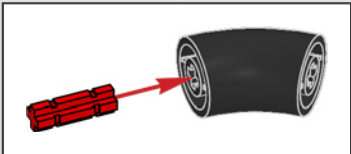
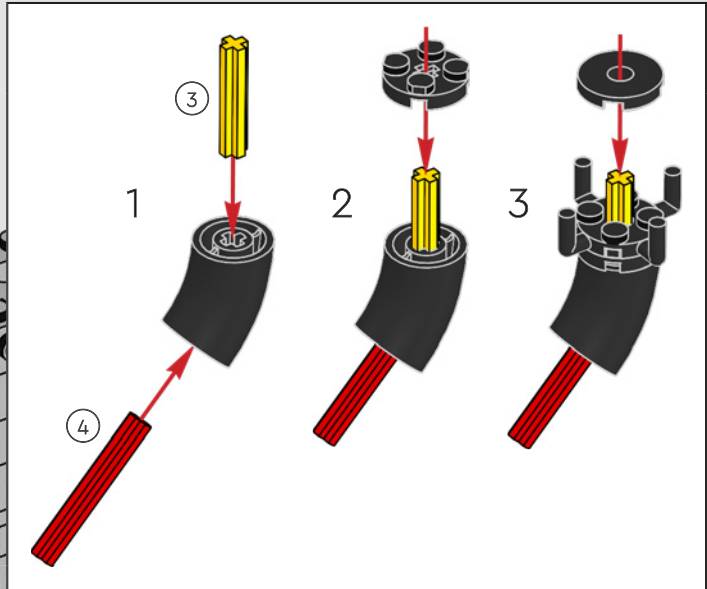



4x

563



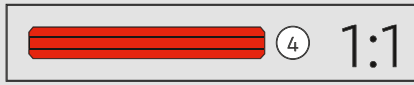
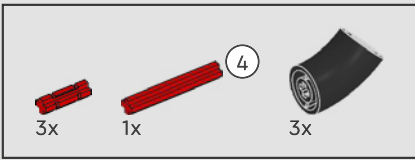

564

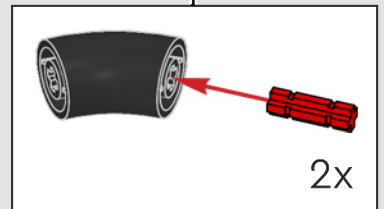
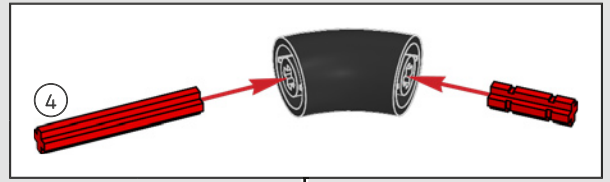

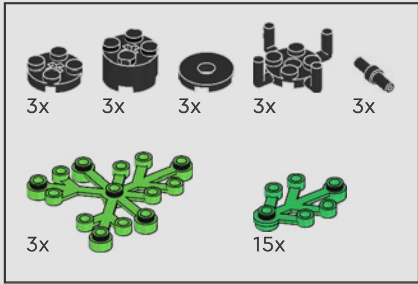
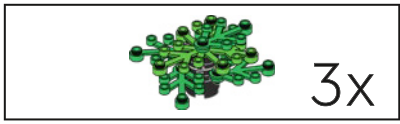

565

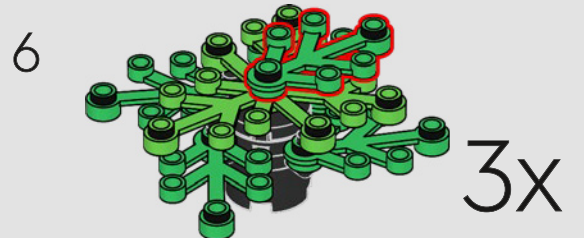
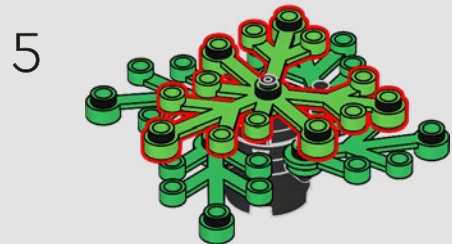
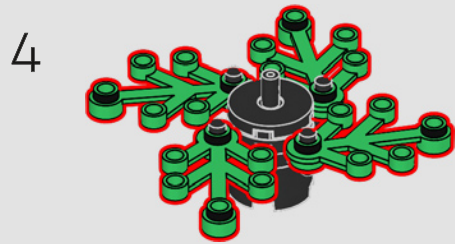
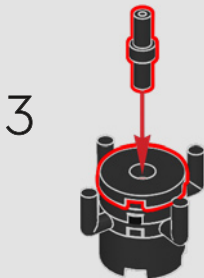
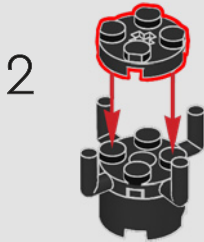
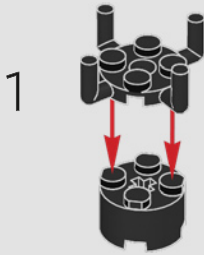



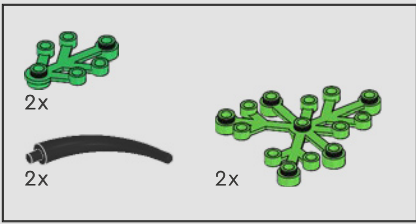

566

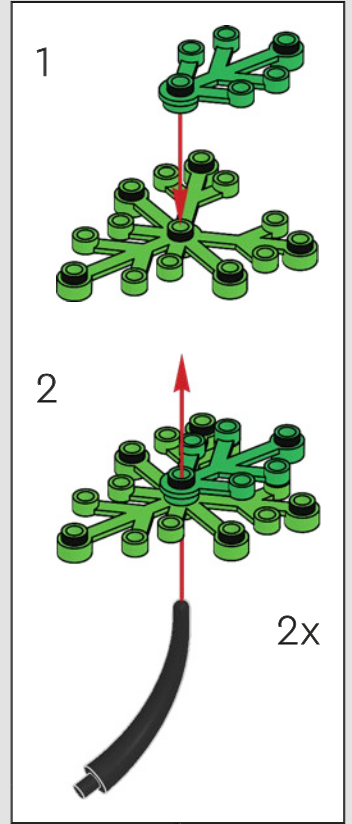

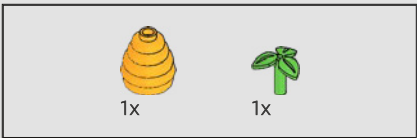

567



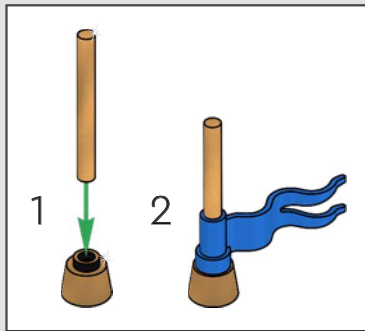
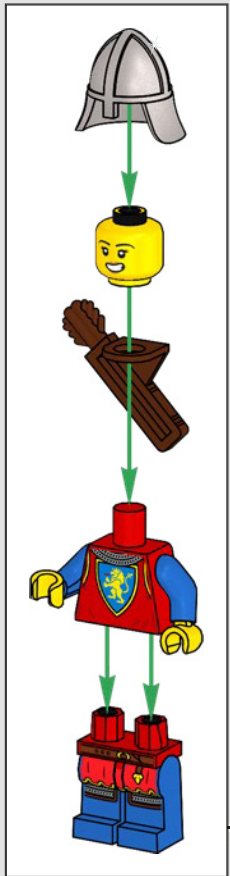



22x

568





12x

569



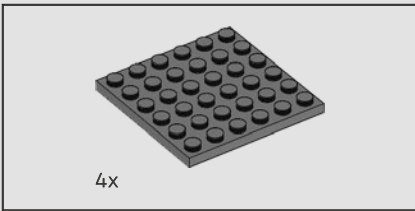

570

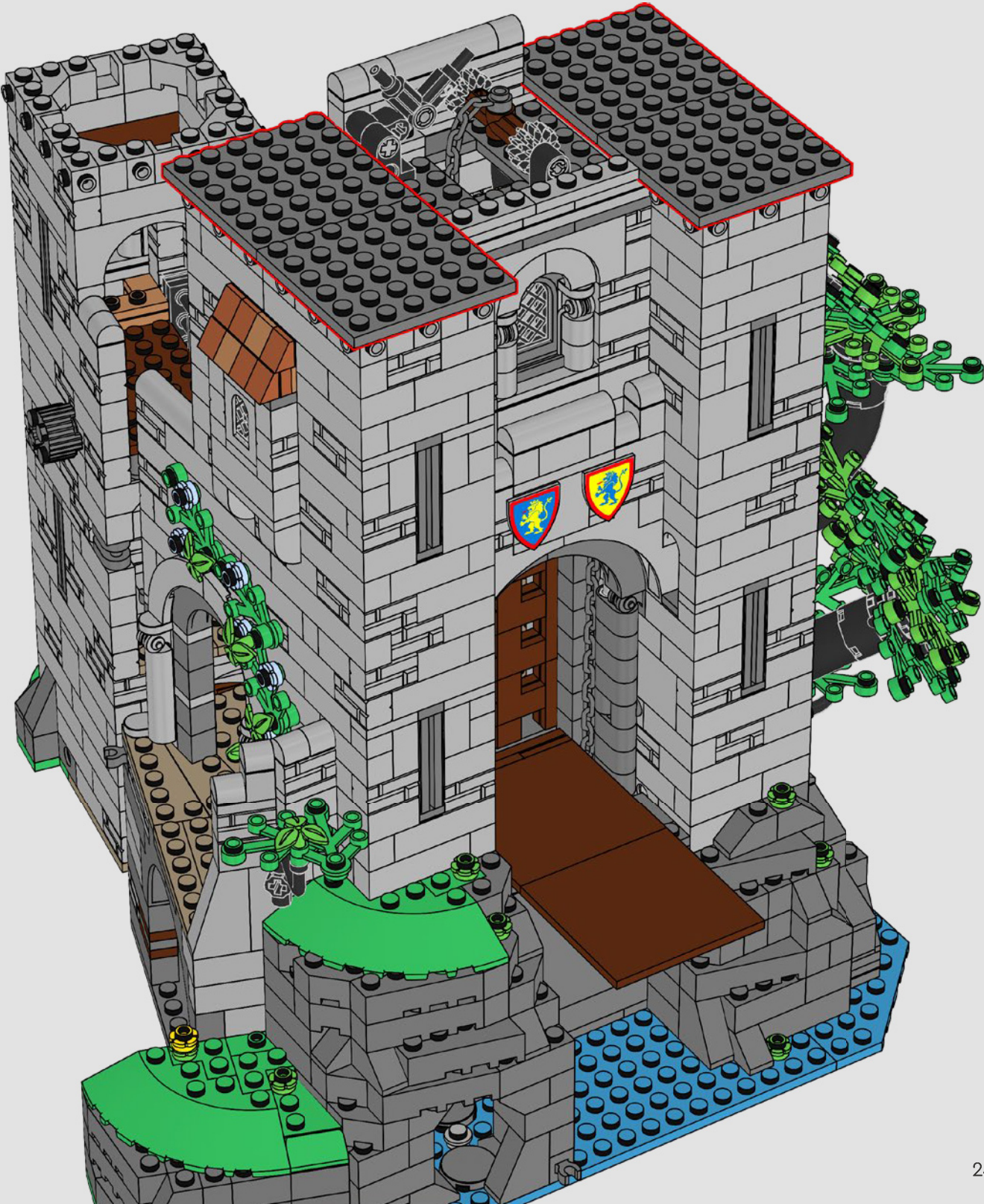

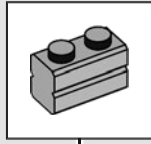
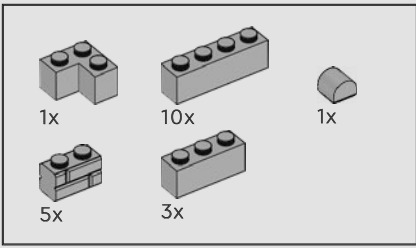

571



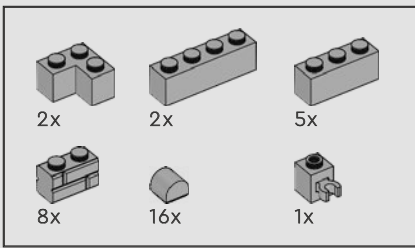

572

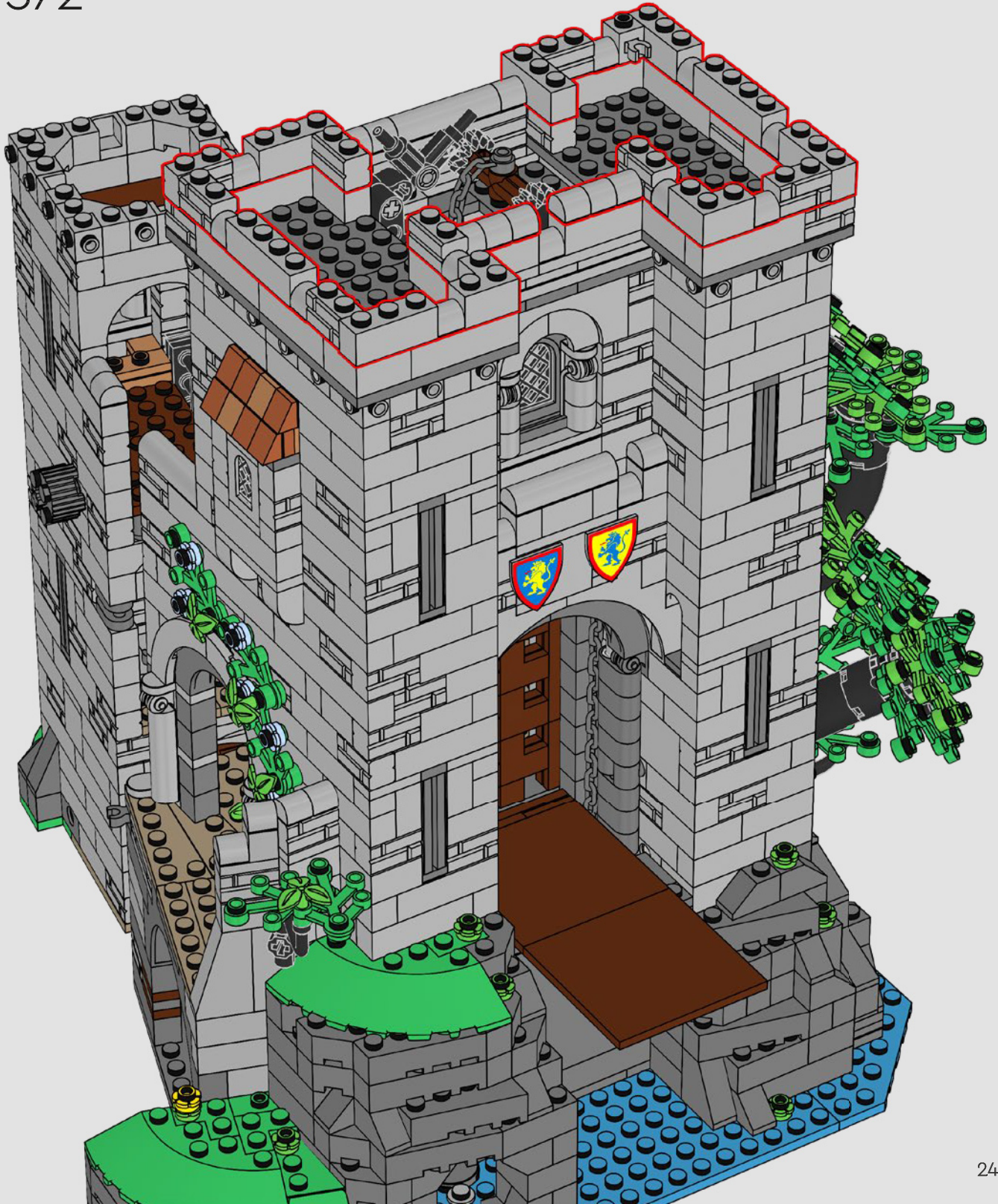

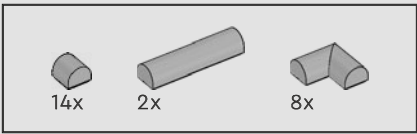

573



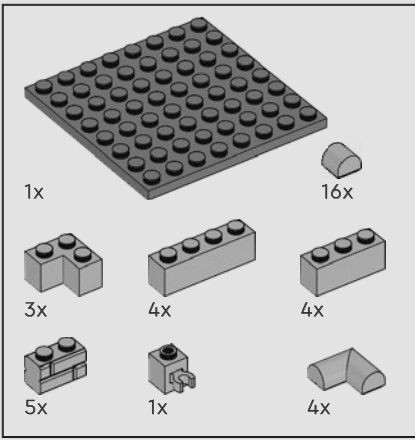

574

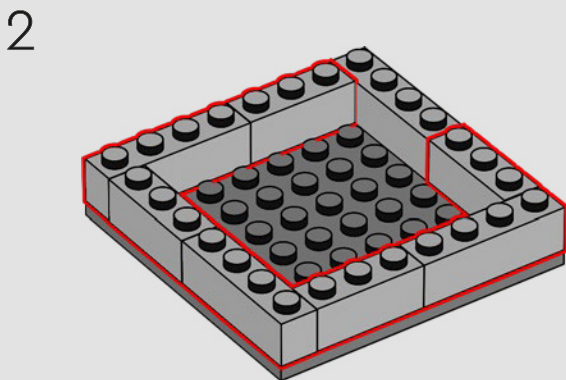
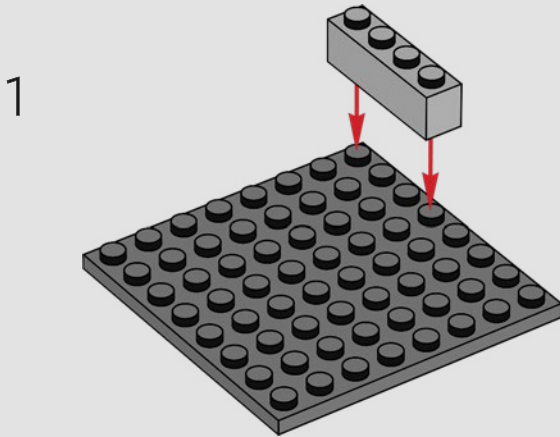

3

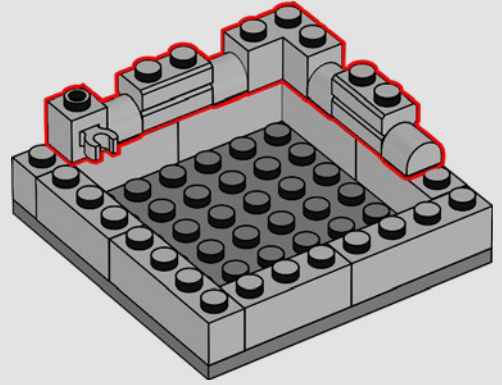

4

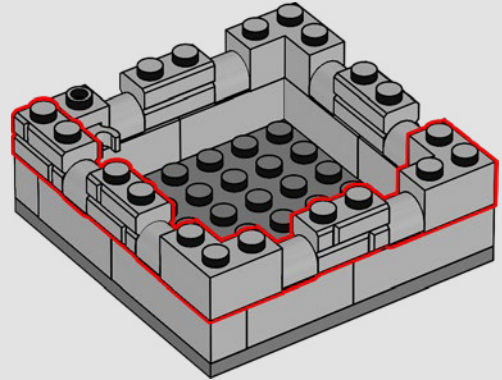

5

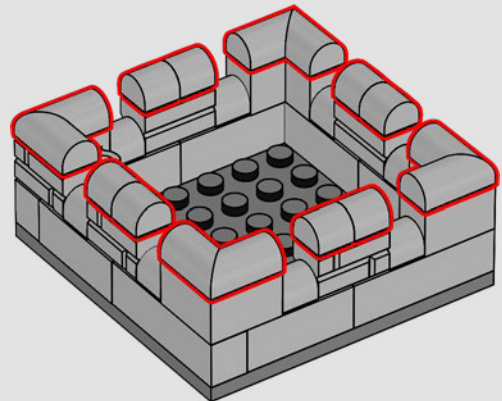





42x

575



42x



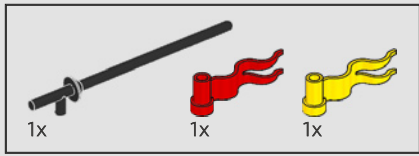

576

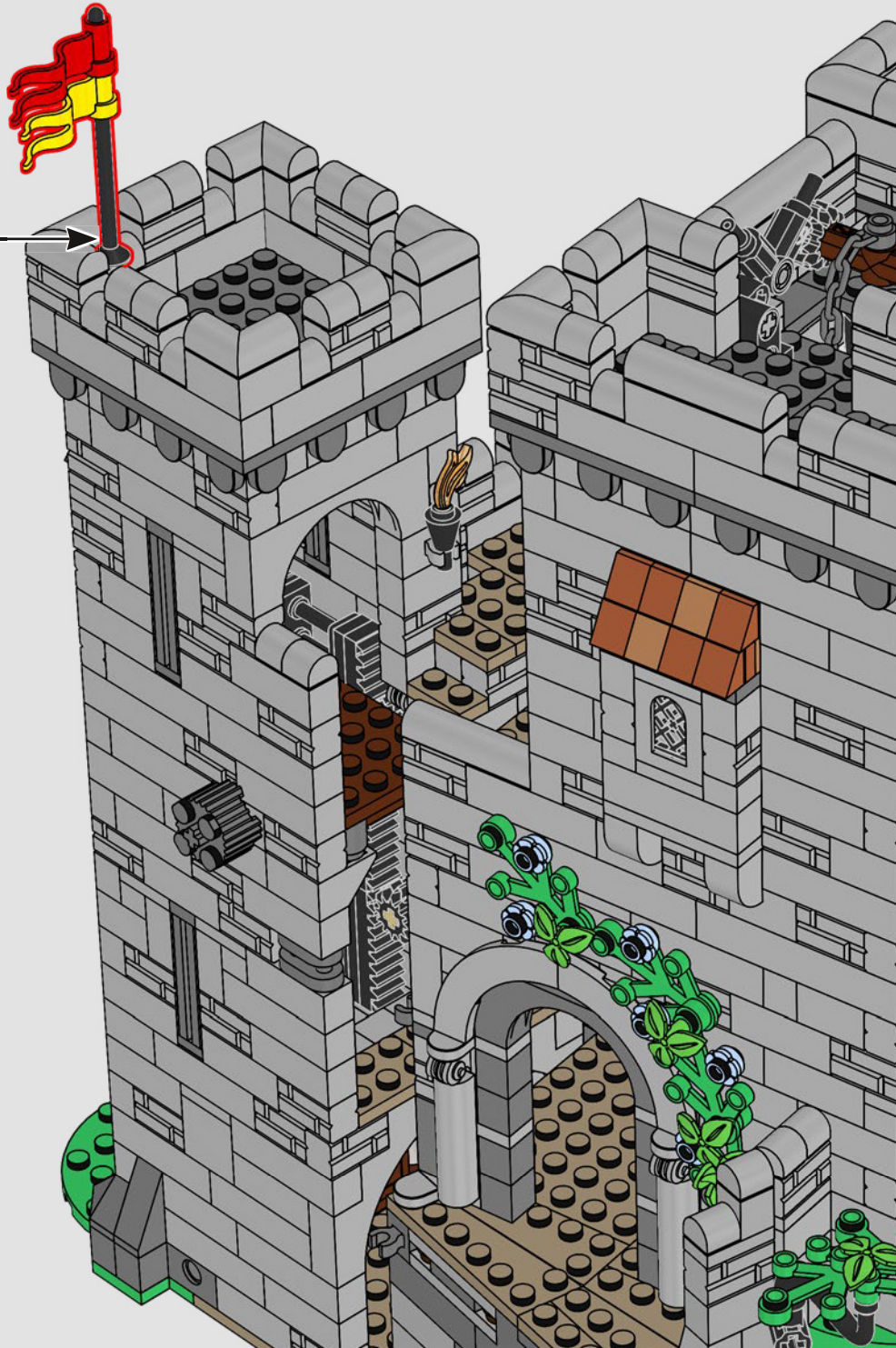
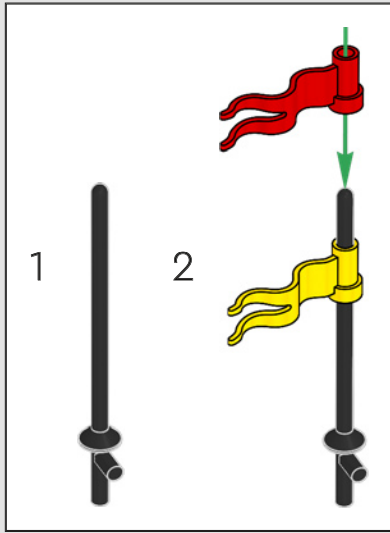



So lovely to see the banner of the House of Lionne flying in the breeze! Now all will know the ruler of these lands.

La bannière de la maison de Lionne est si belle lorsqu'elle vole au vent ! Maintenant, tout le monde saura qui règne sur ces terres.

¡Qué hermoso es ver la bandera de la Casa de Lionne ondeando al viento! Ahora todos sabrán quién gobierna en estas tierras.

577

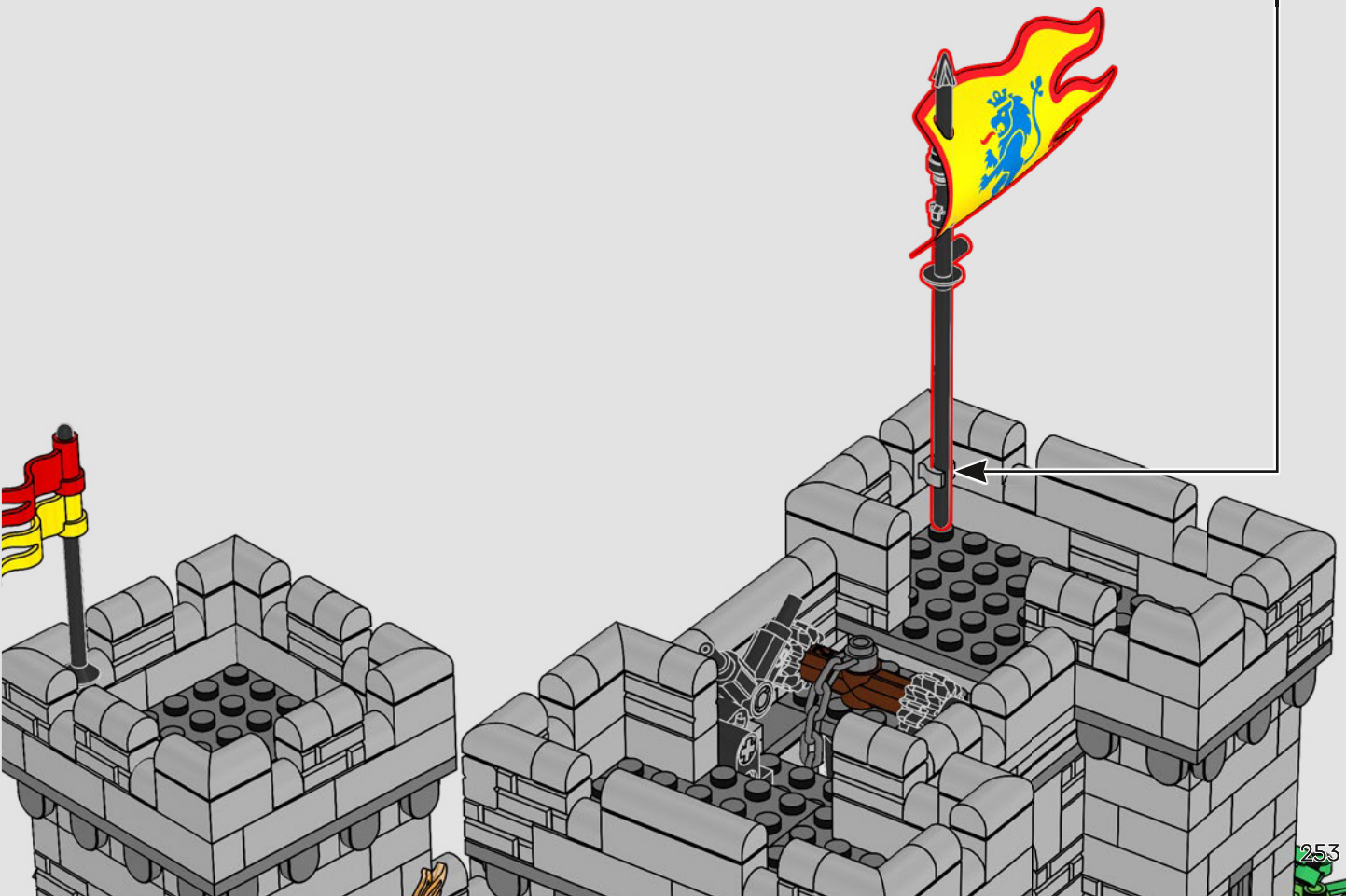
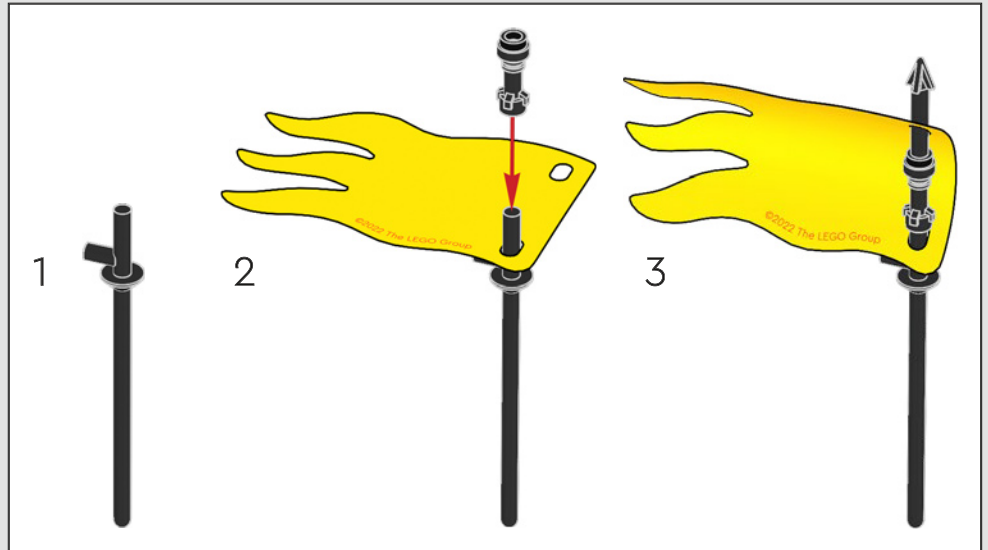
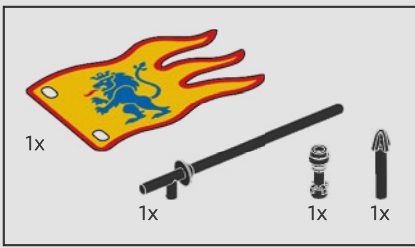

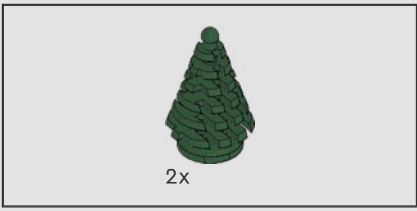

578





Looks like we will be having some visitors from the House of Black Falcon, hopefully the cook has put something good in the oven!

On dirait que nous allons recevoir des visiteurs de la maison du Faucon Noir. Espérons que le cuisinier a mis quelque chose de bon au four !

Parece que tendremos visitantes de la Casa del Halcón Negro. ¡Esperemos que el cocinero haya puesto algo bueno en el horno!

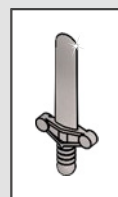
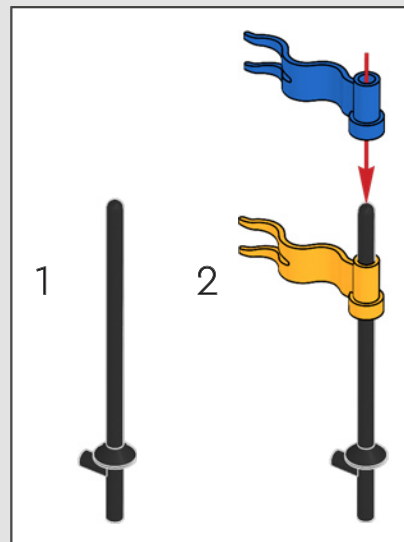
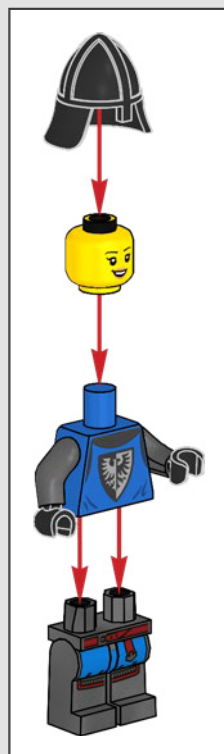



1

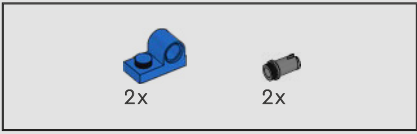

2

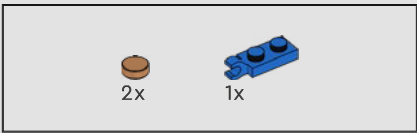
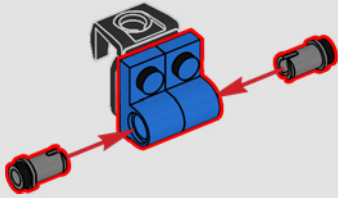

3

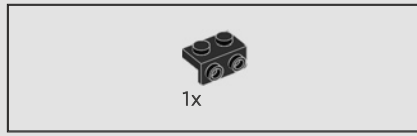
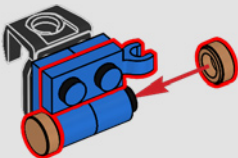

4

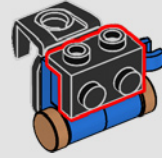

5



6

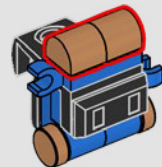

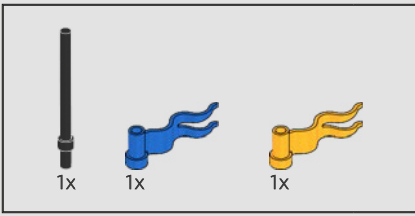

7

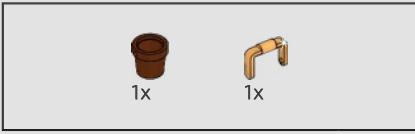
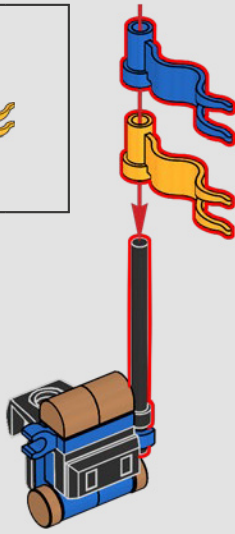

8

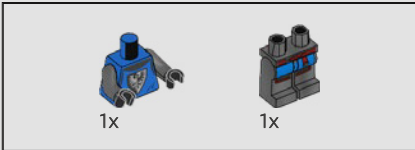
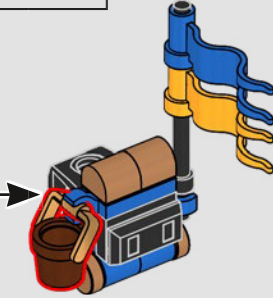
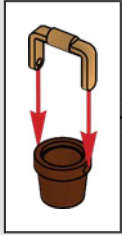

9

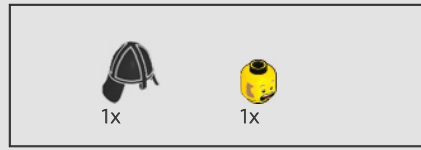
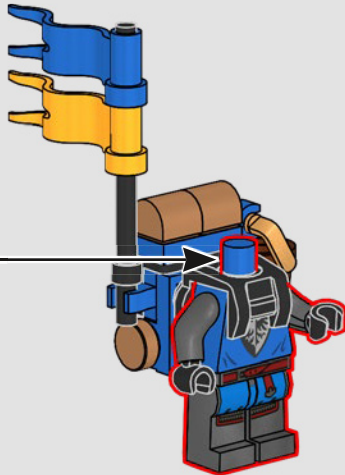
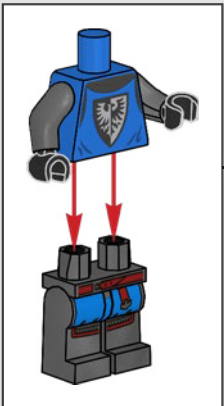

10

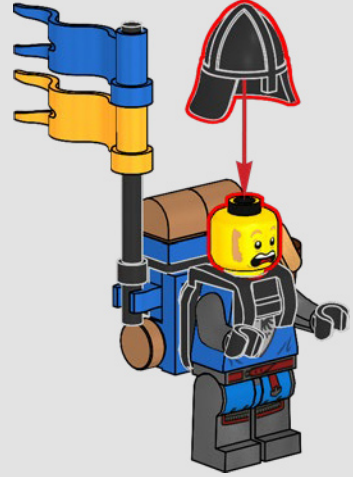

11

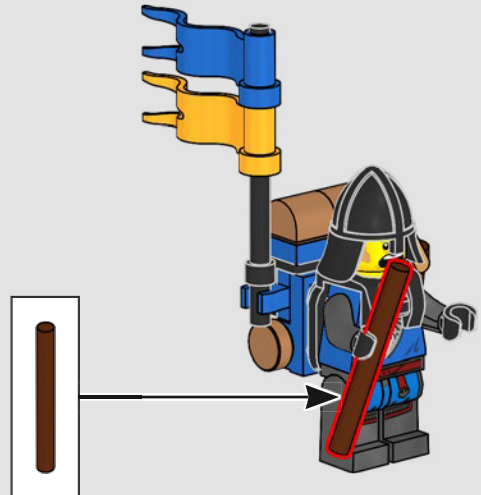

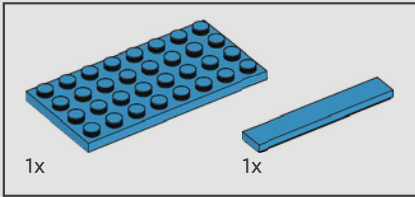
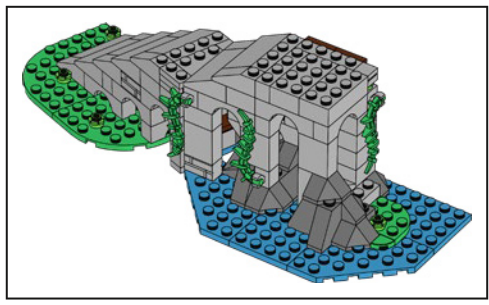

579

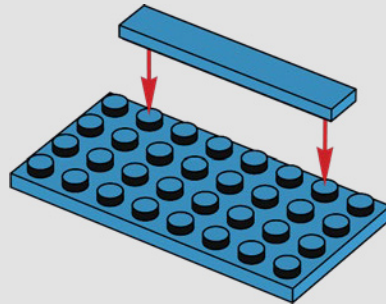

580

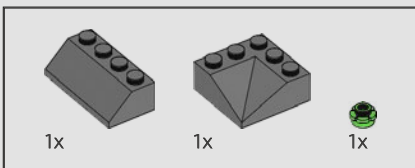
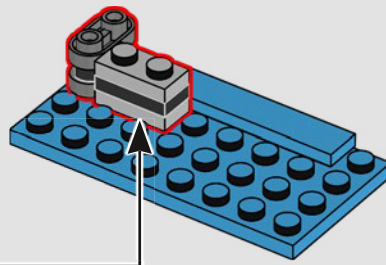
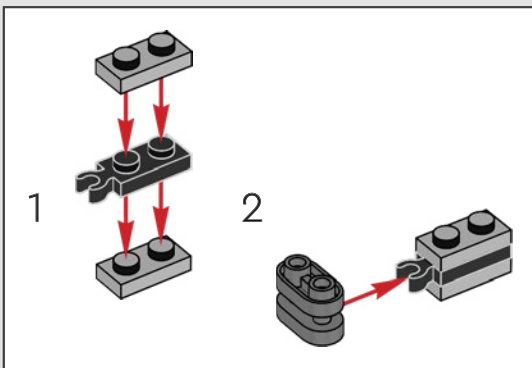

581

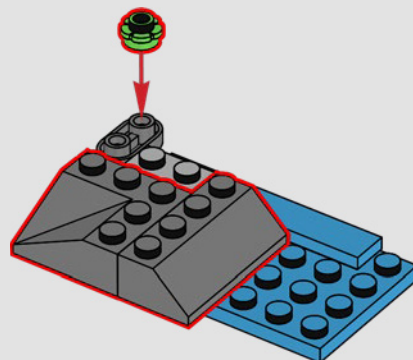

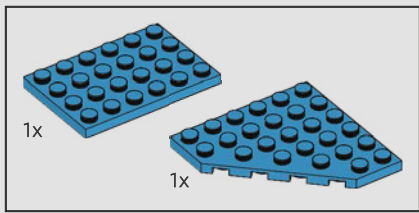

582

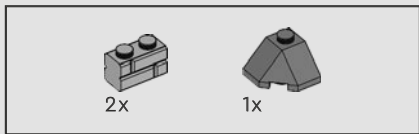
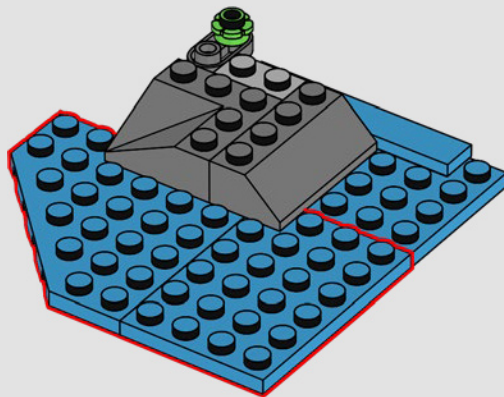

583

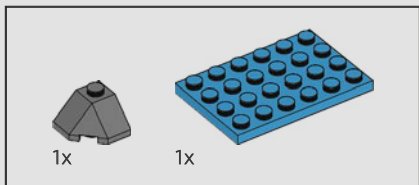
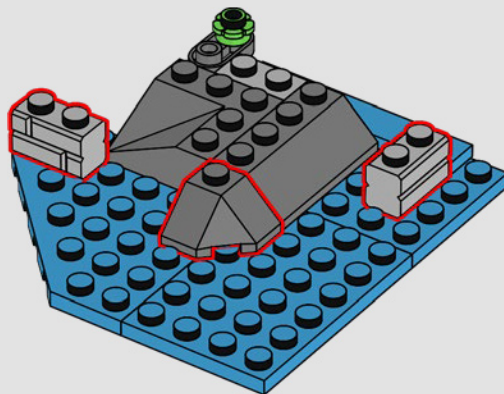

584

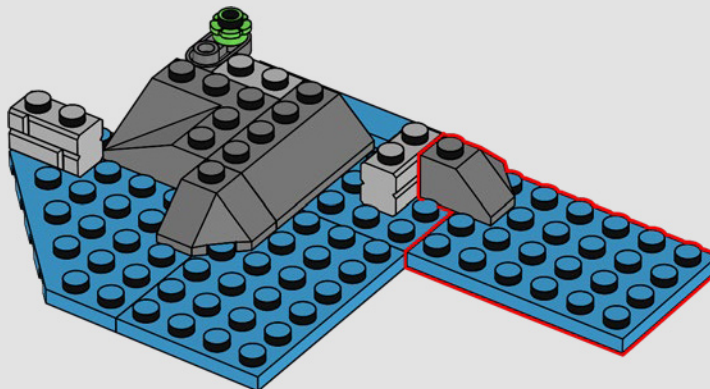

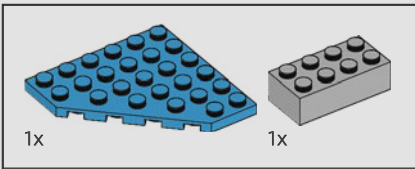

585

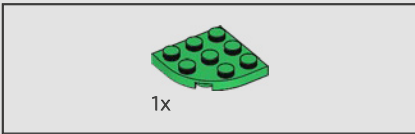
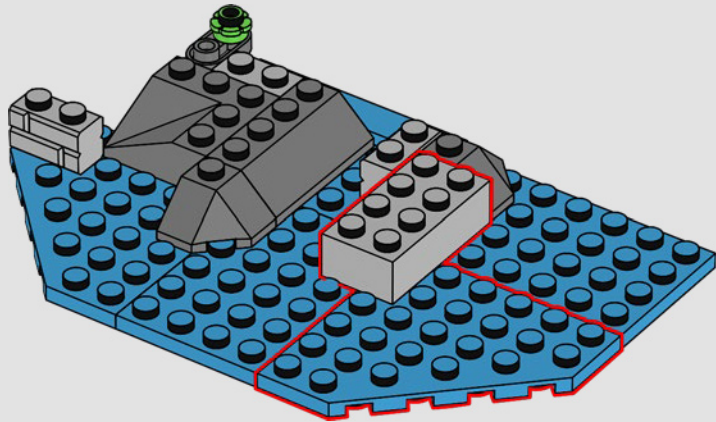

586

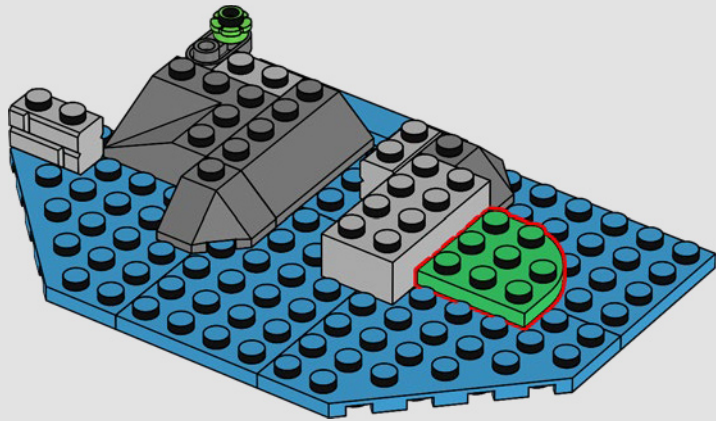

587

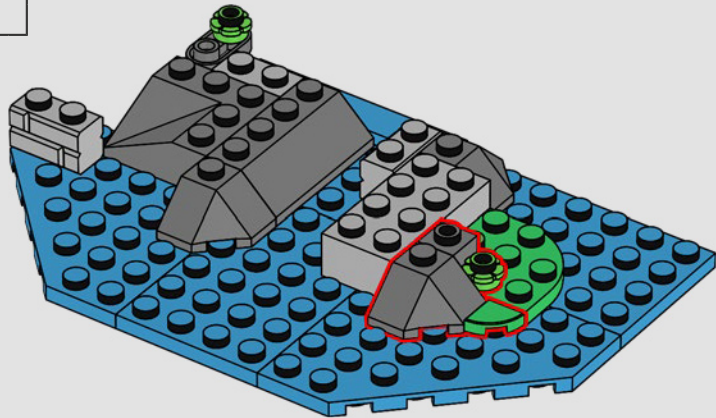

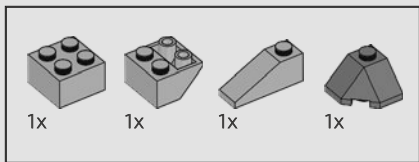

588

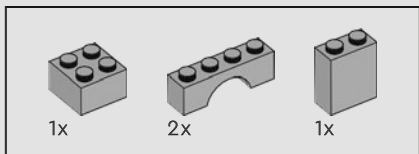
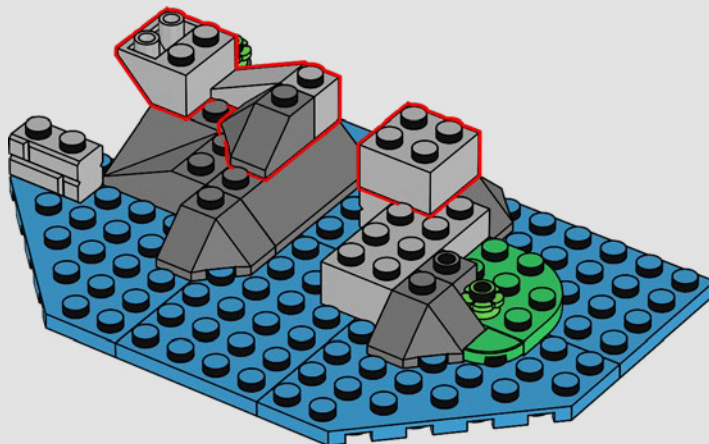

589

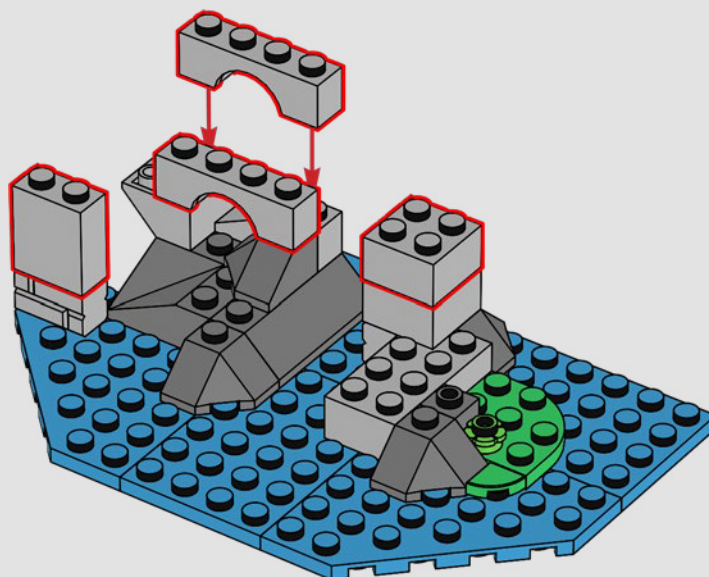

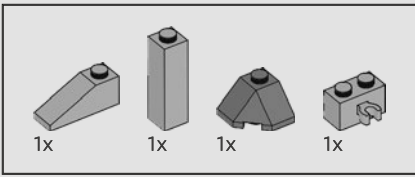

590

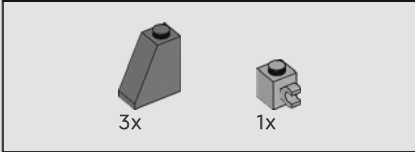
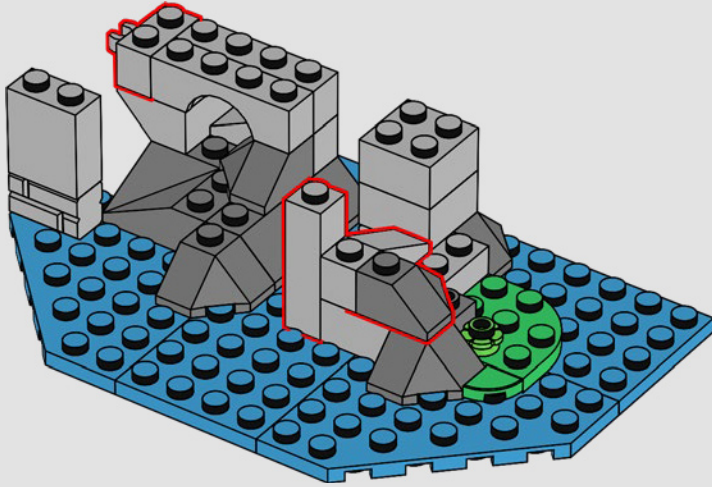

591

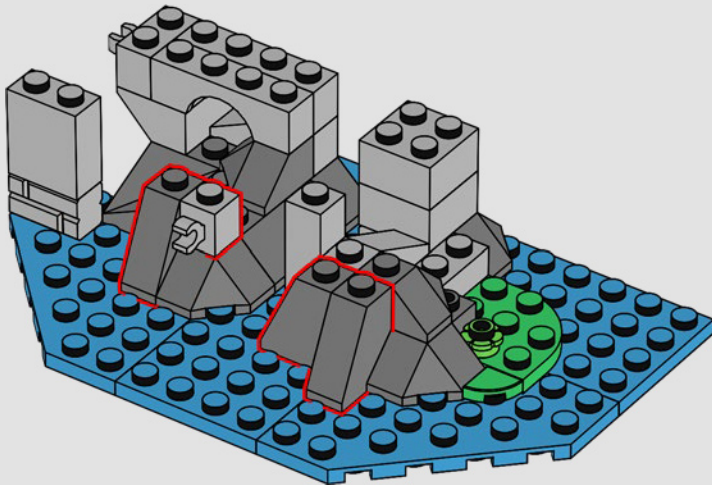

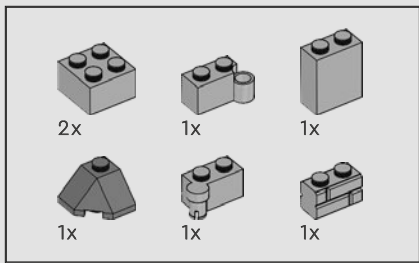

592

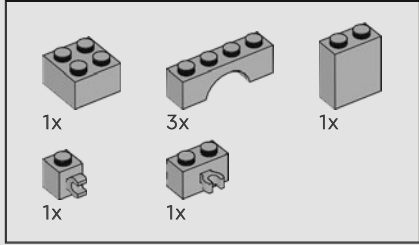
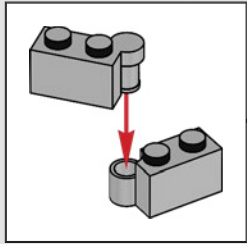
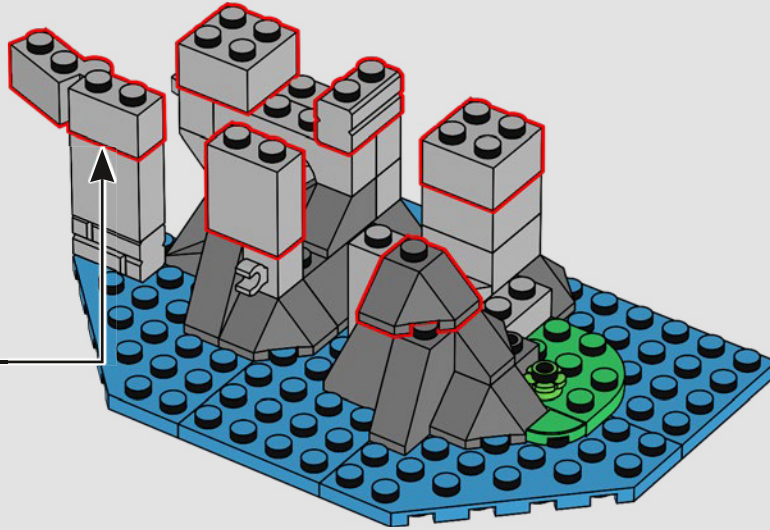

593

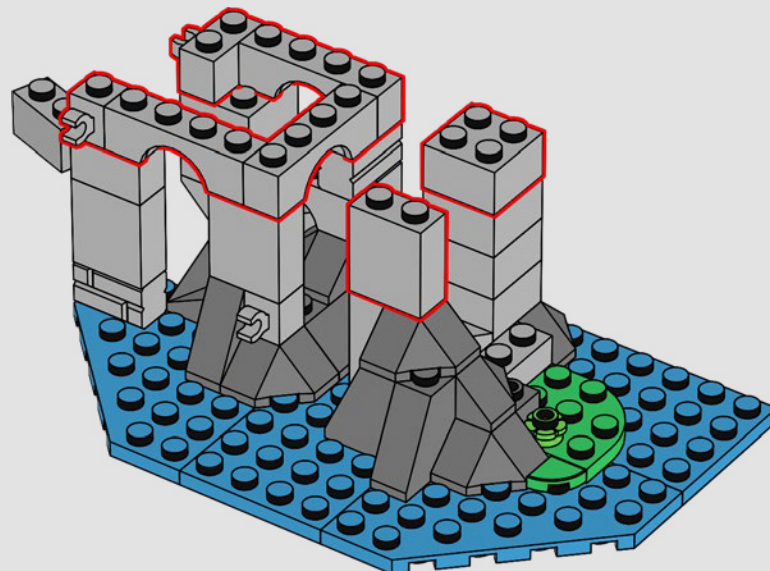

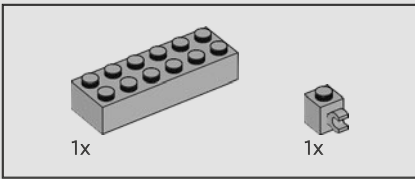

594

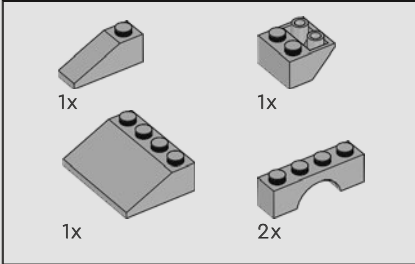
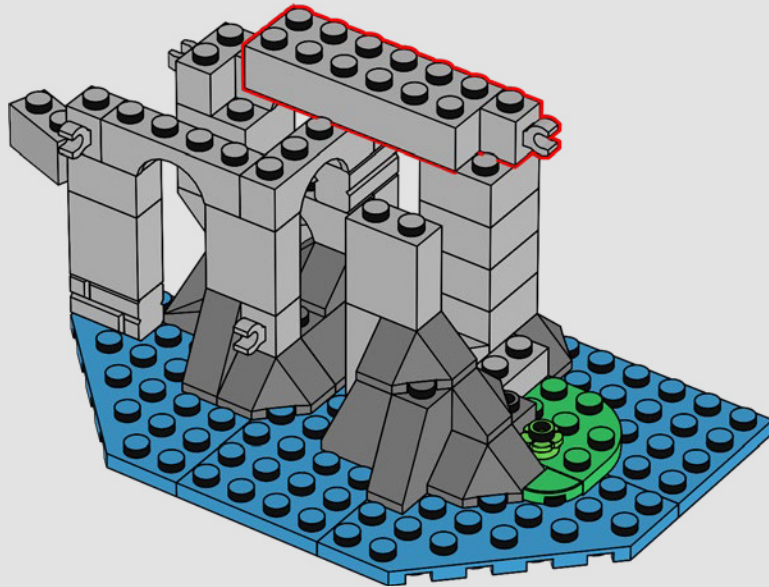

595

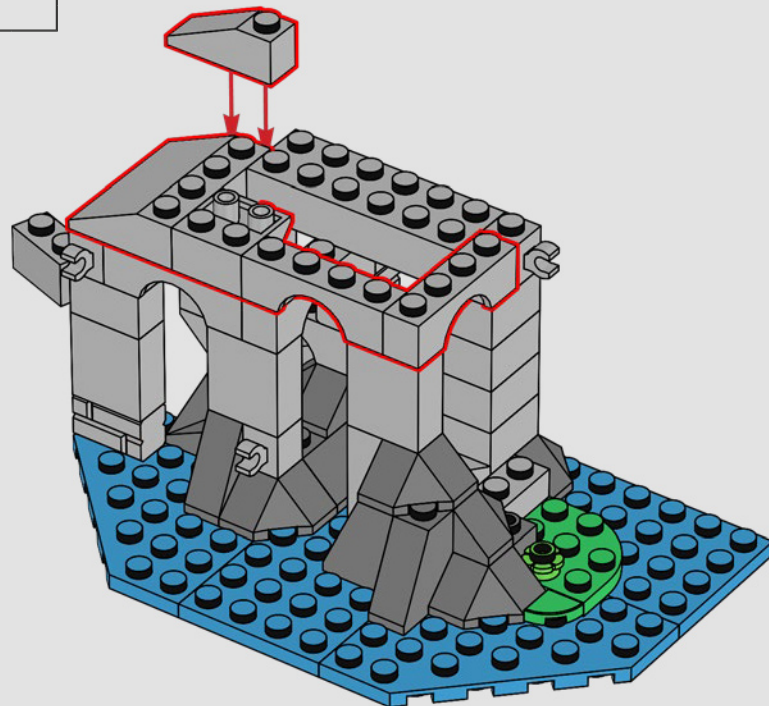

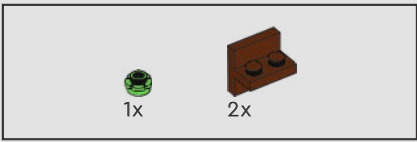

596

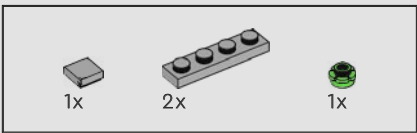
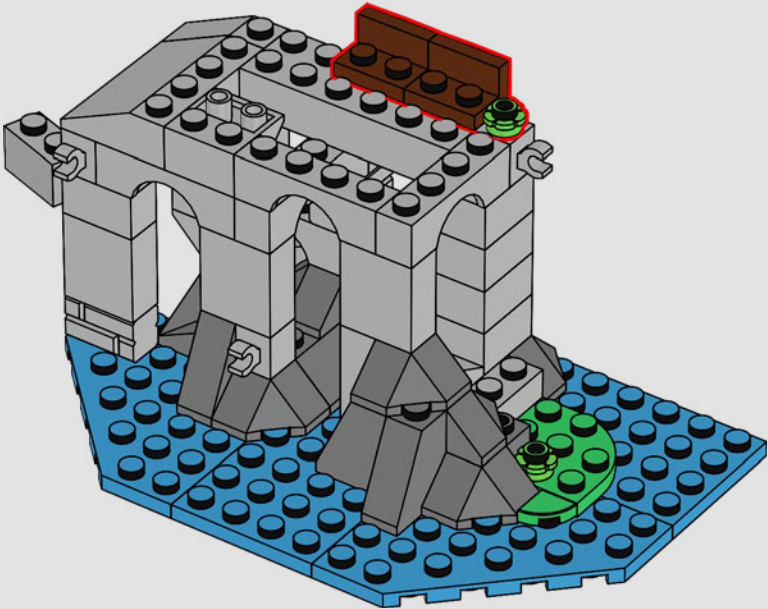

597

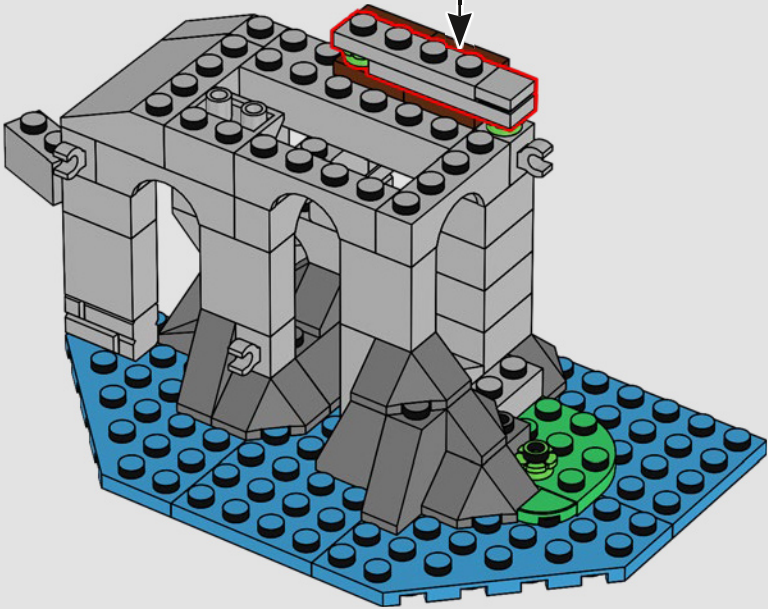
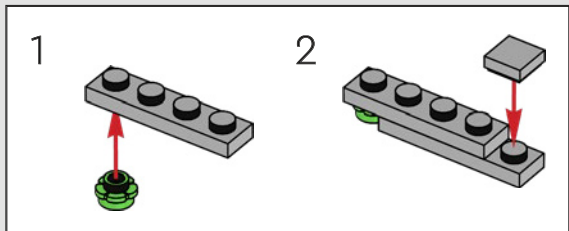

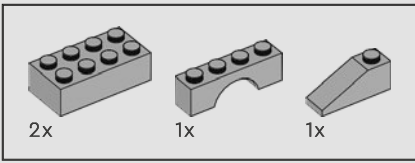

598

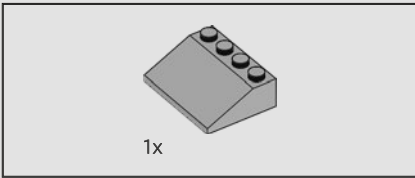
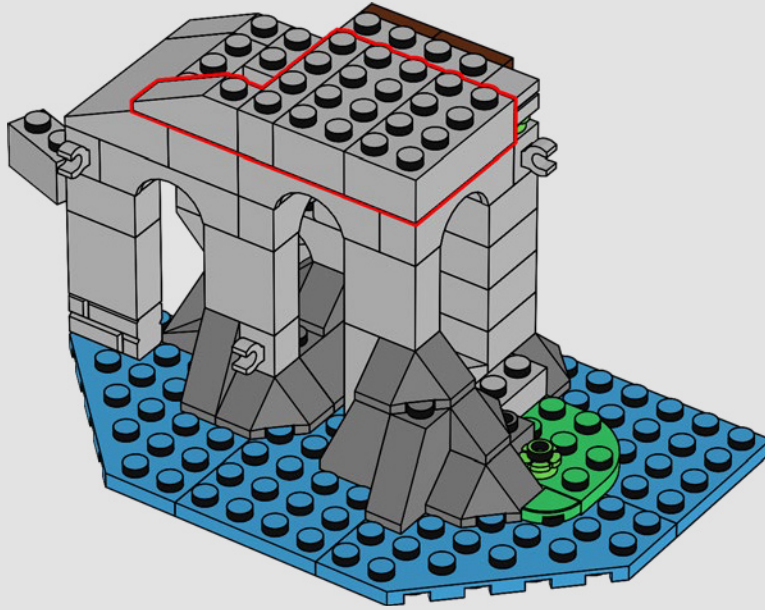

599

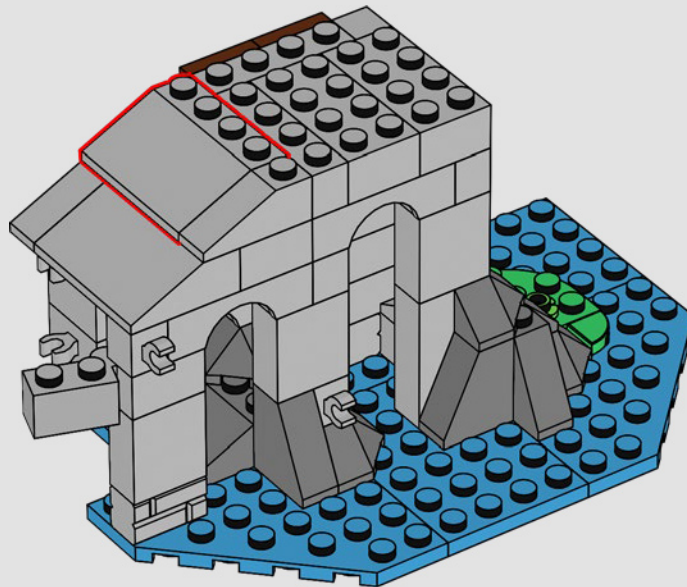

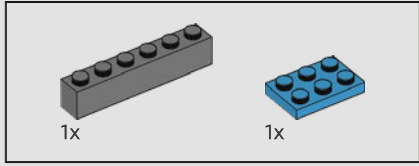
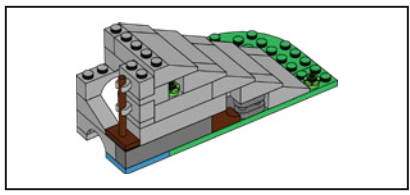

600

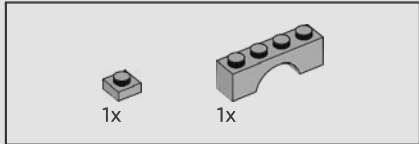
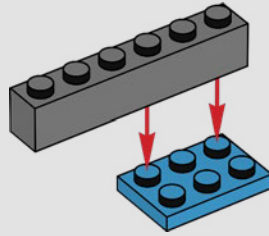

601

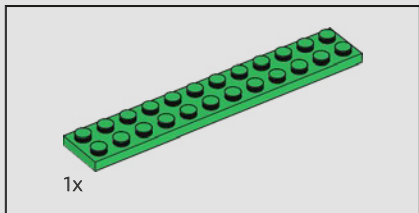
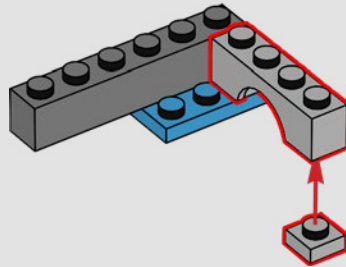

602

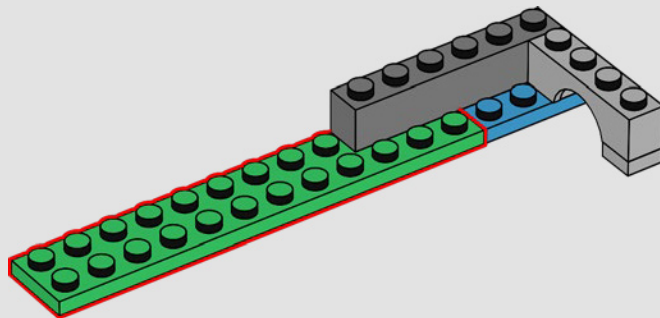

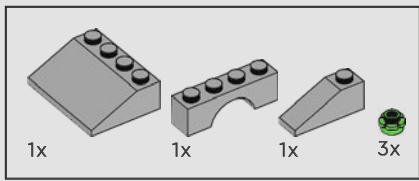

606

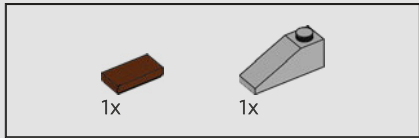
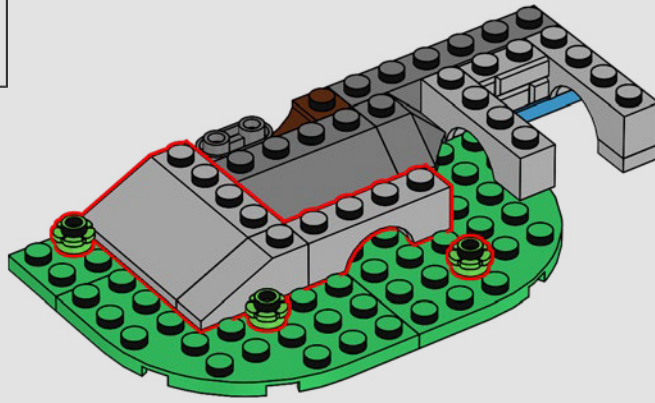

607

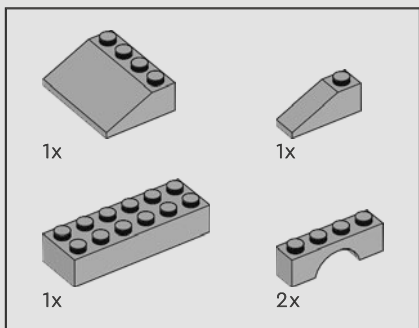
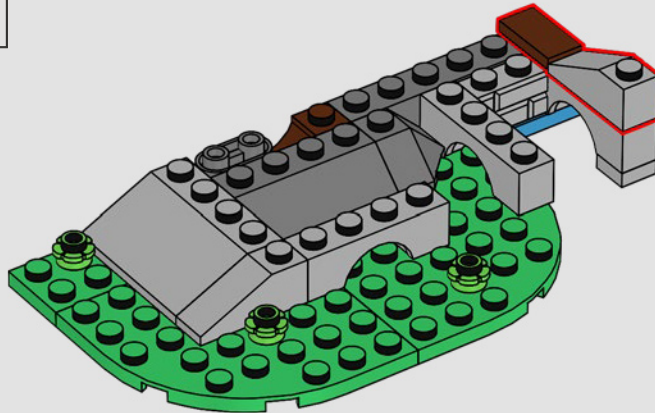

608

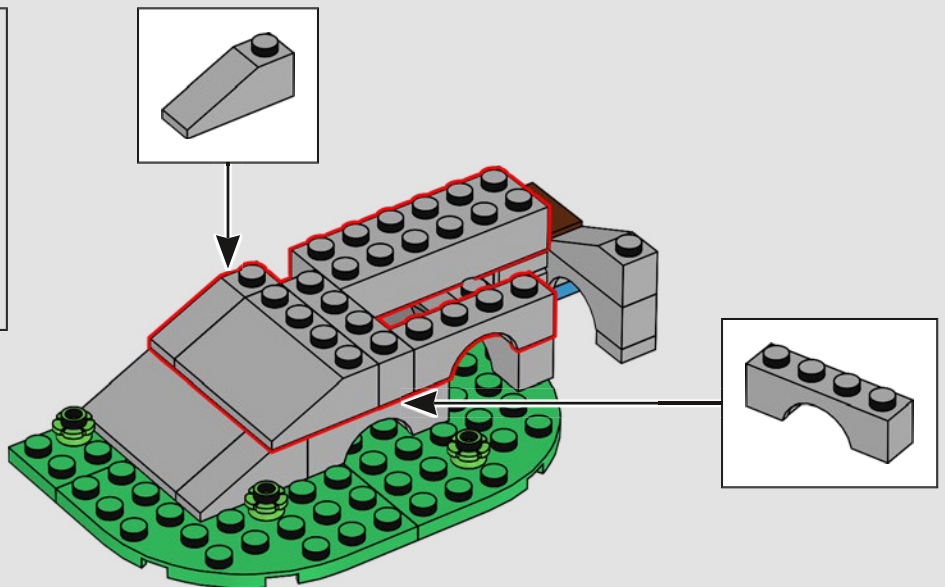

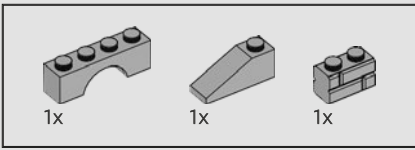

609

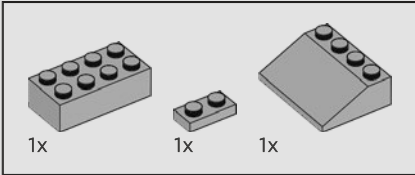
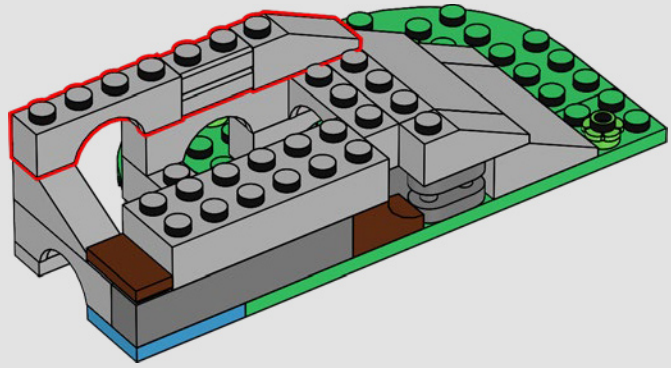

610

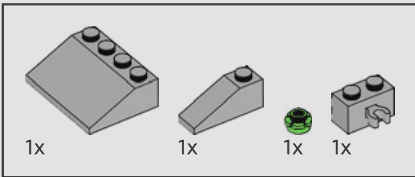
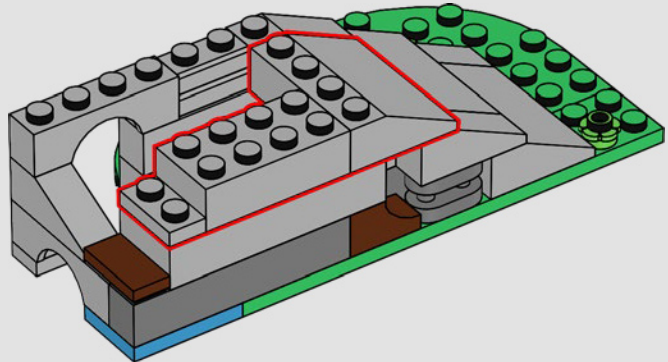

611

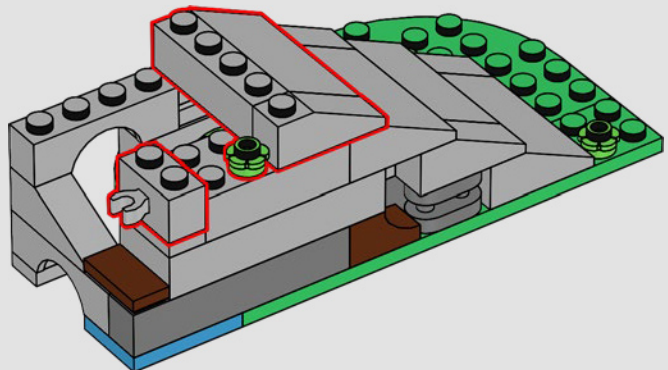

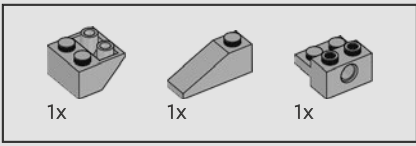

612

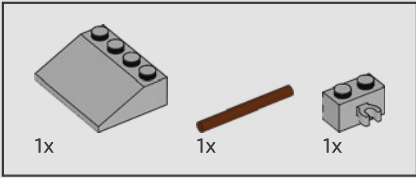
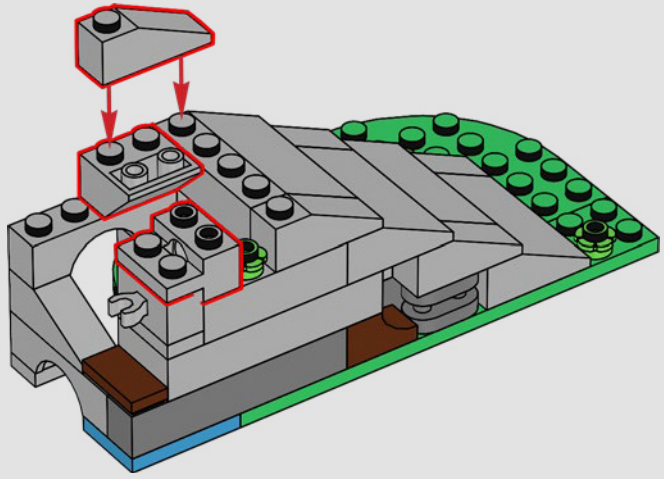

613

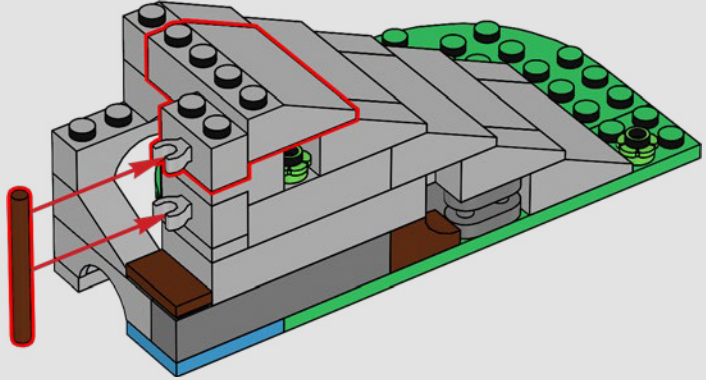

614

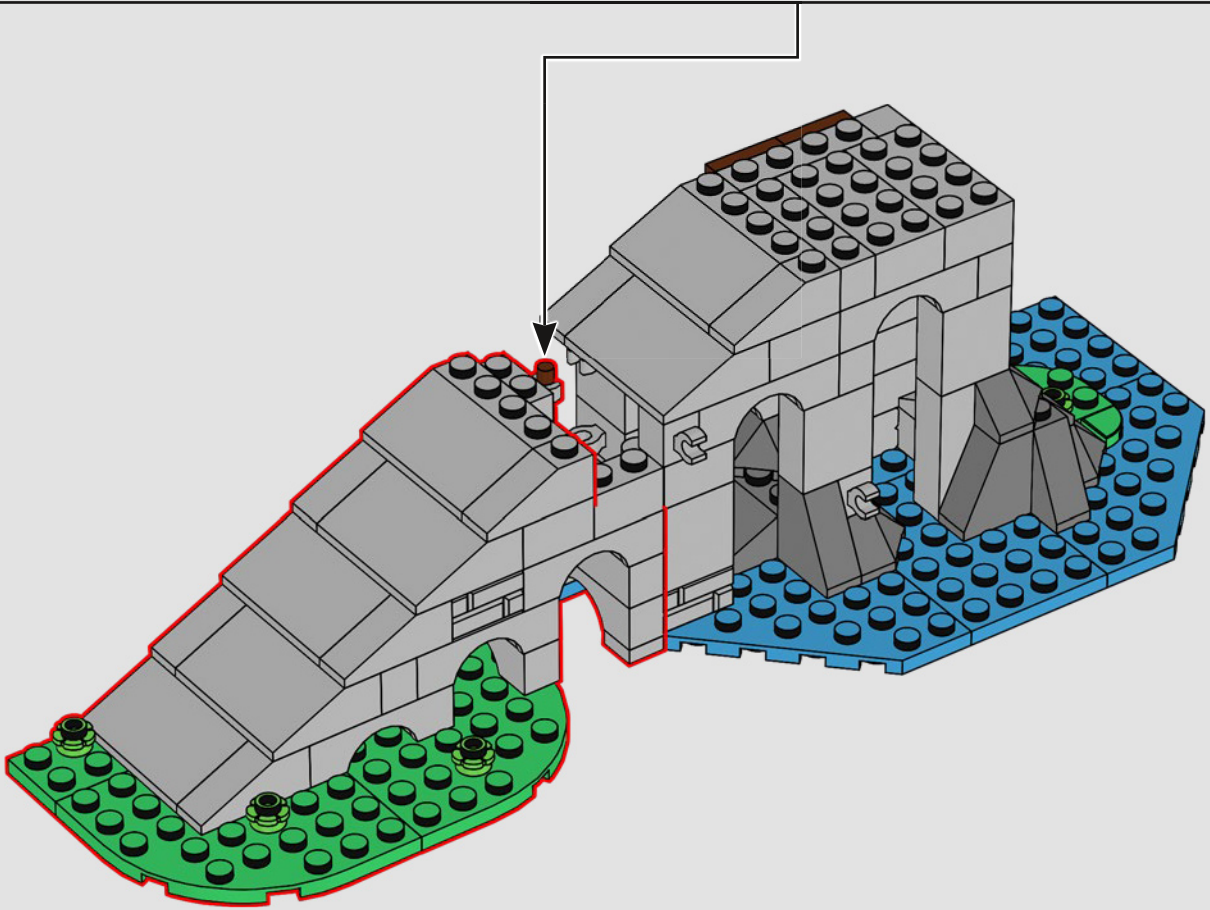

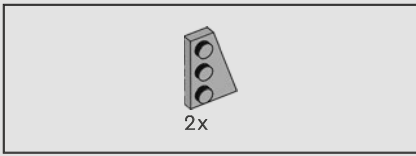

615

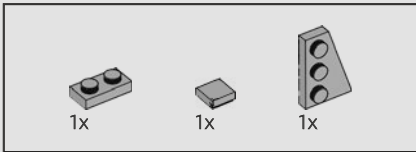
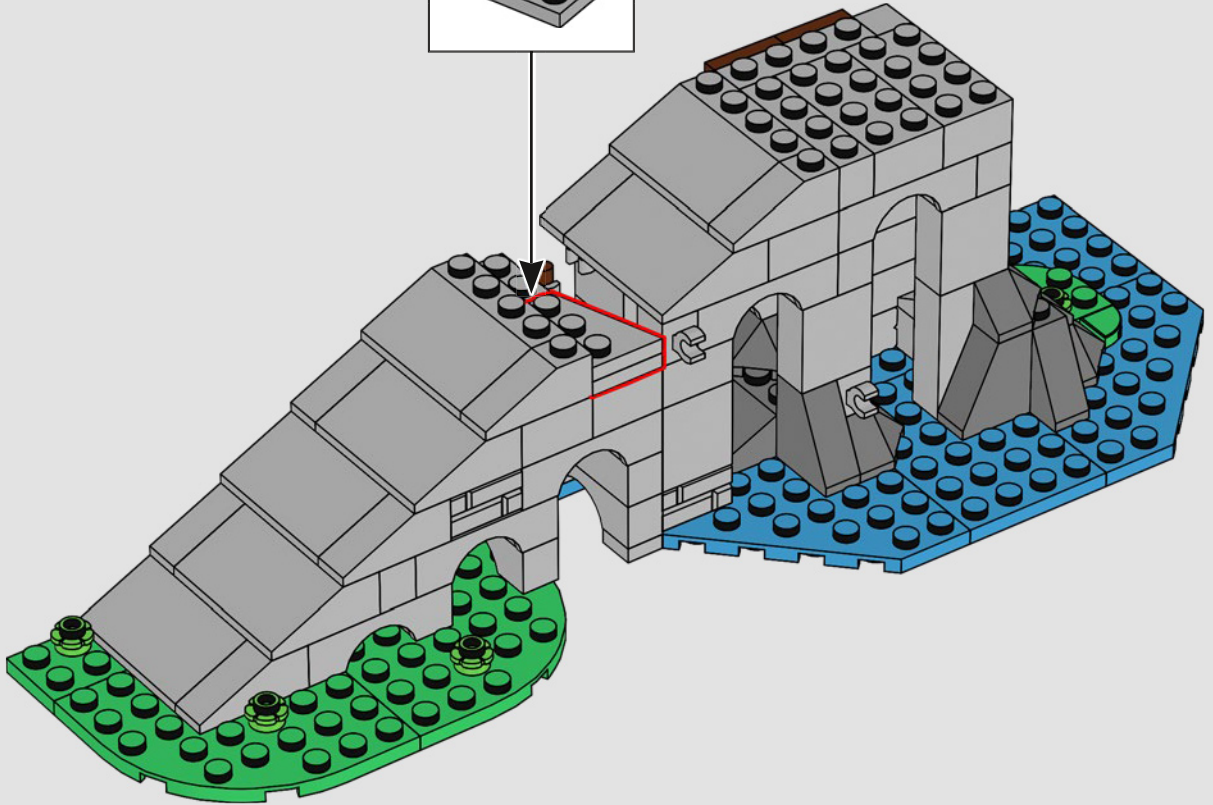
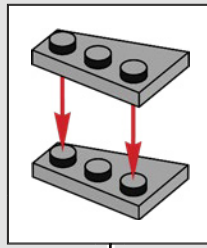

616

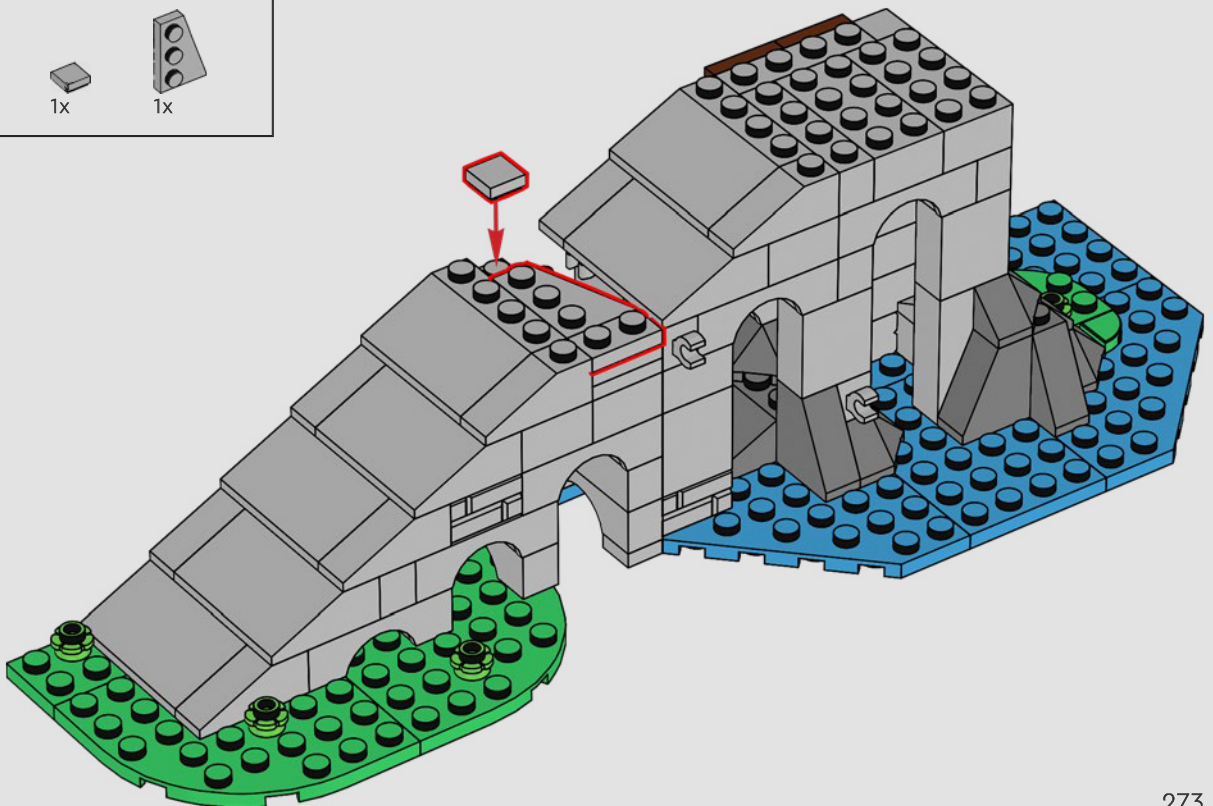

617

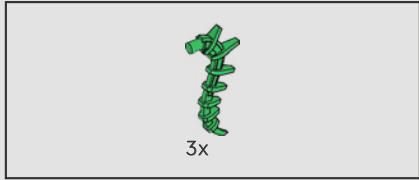
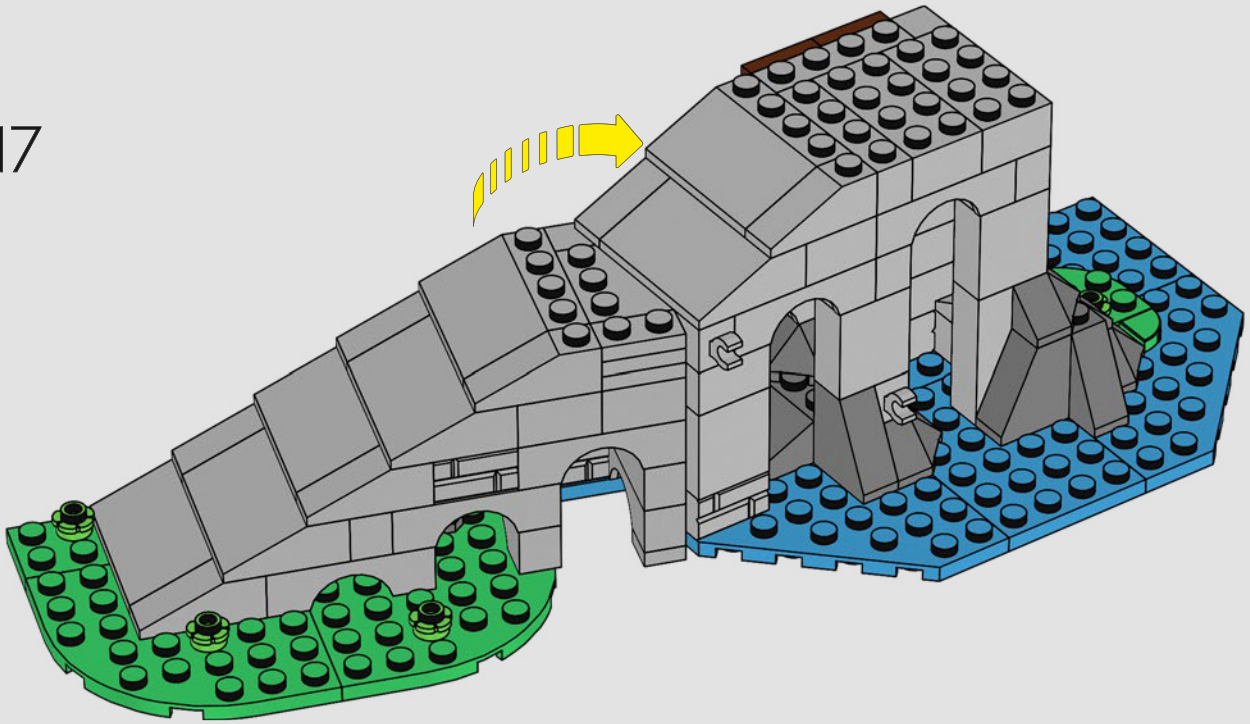

618

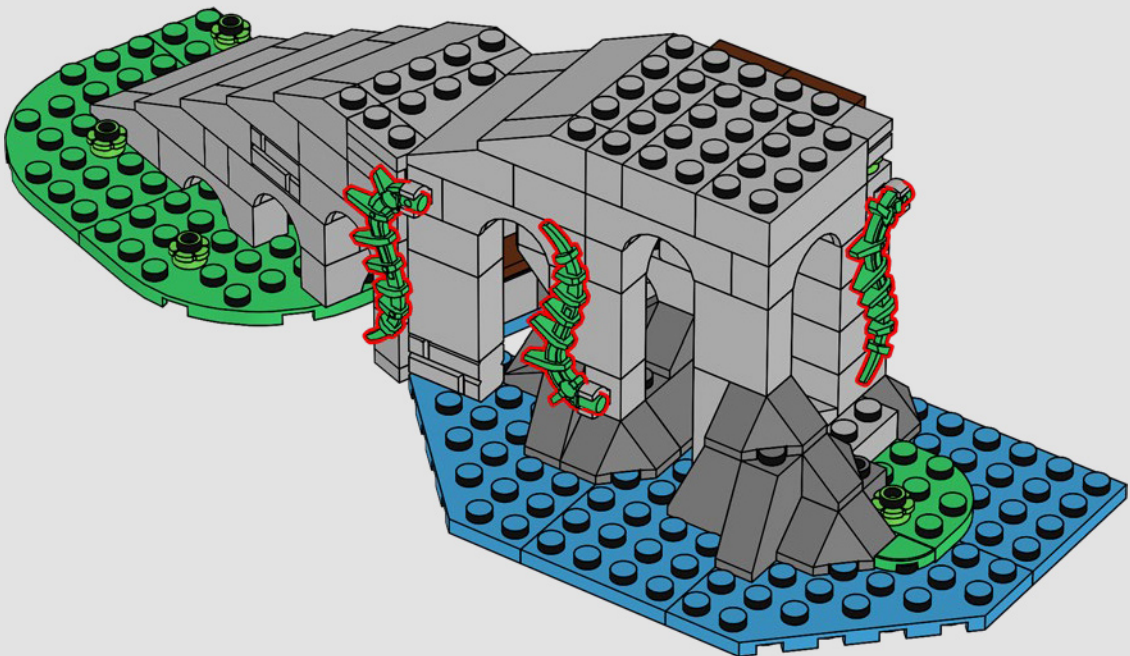

619



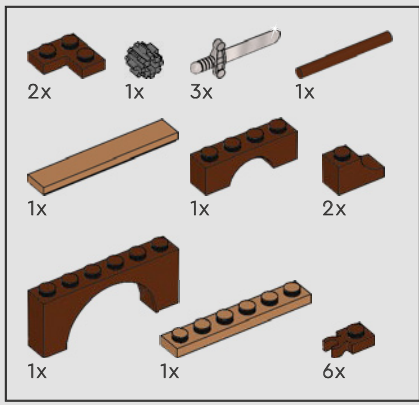

620

1

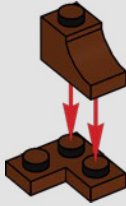

3

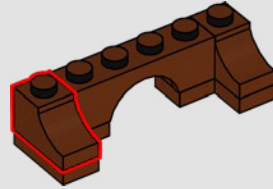

2

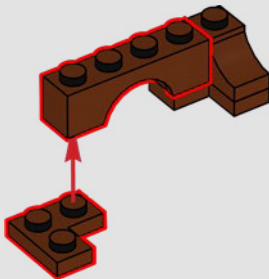

4

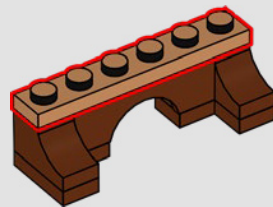

5

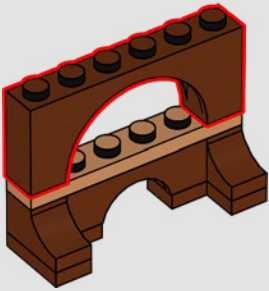

7

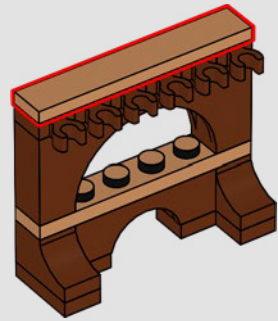

6

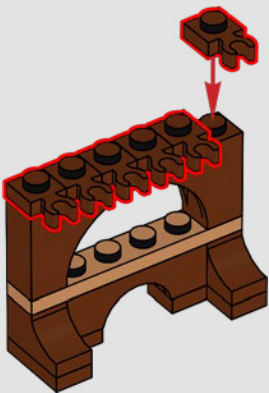

8

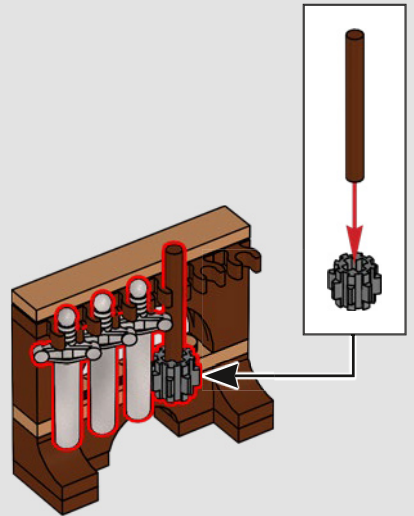





NOW at last it's clear! The sections join to create a MIGHTY fortress!

ENFIN, tout est clair ! Les sections se rejoignent pour créer une PUISSANTE forteresse !

AHORA todo está claro. ¡Las secciones se unen para crear una IMPONENTE fortaleza!





- 1x 6234807
- 2x 6240495
- 6x 6206149
- 1x 306201
- 1x 6168642
- 3x 6186681
- 1x 614101
- 1x 6360263
- 1x 6406415
- 18x 6250591
- 1x 6253309
- 1x 4651445
- 2x 6328195
- 4x 6388018
- 9x 302401
- 4x 6383985
- 2x 307001
- 5x 300501
- 10x 6258135
- 6x 4558952
- 2x 6198979
- 13x 6218841
- 1x 6055541
- 1x 6315564
- 2x 4558168
- 2x 6296132
- 1x 6289366
- 4x 6321349
- 1x 6408195
- 2x 6326680
- 1x 6319748
- 1x 6377511
- 1x 6139454
- 2x 6164293
- 1x 6210076
- 1x 6293665
- 2x 6320300
- 11x 302301
- 21x 300401
- 4x 306901
- 2x 6070698
- 1x 6359891
- 2x 6047220
- 2x 4520970
- 9x 362201
- 1x 362301
- 2x 4558168
- 4x 6168618
- 1x 302101
- 6x 371001
- 6x 301001
- 2x 6373439
- 1x 4583297
- 4x 300101
- 1x 302001
- 2x 6147792
- 1x 6106183
- 2x 366601
- 1x 346001
- 1x 303201
- 1x 6409588
- 1x 6409580
- 1x 6409509
- 1x 244501
- 1x 6324176
- 4x 4161734
- 1x 4159553
- 3x 4118793
- 1x 4579260
- 1x 4125253
- 3x 6145570
- 2x 6374151
- 1x 4666579
- 4x 4624086
- 1x 6066344
- 4x 6236425
- 3x 4655900
- 1x 6284163
- 1x 4109995
- 1x 6024495
- 6x 4114026
- 13x 4124456
- 2x 4113917
- 1x 6360029
- 10x 6221467
- 3x 4185177
- 1x 6100077
- 3x 6173057
- 4x 6132769
- 1x 4618651
- 1x 6131896
- 1x 6328182
- 5x 6211966
- 1x 6343565
- 2x 4582437
- 2x 4118790
- 2x 4666999
- 2x 4201062
- 2x 6115031
- 1x 6294227
- 1x 4157277
- 1x 4114001
- 4x 6223427
- 2x 6215539
- 2x 6406416
- 4x 6100565
- 1x 6378120
- 2x 307021
- 1x 6393847
- 5x 4142865
- 4x 6252037
- 1x 6209519
- 4x 6268946
- 9x 6406251
- 1x 6405989
- 9x 6351814
- 1x 6343017
- 3x 6129995
- 1x 243121
- 2x 366621
- 1x 6334630
- 1x 6344028
- 2x 6289361
- 1x 6370037
- 14x 306923
- 2x 6248822
- 6x 6365486
- 1x 6387371
- 6x 4140586
- 2x 6354661
- 2x 6299413
- 1x 6408141
- 2x 4587840
- 3x 6335192
- 3x 6268955
- 1x 4275815
- 1x 6370045
- 2x 6307275
- 1x 379523
- 1x 6408305
- 1x 346023
- 14x 6299813
- 6x 306224
- 1x 6288000
- 1x 6182787
- 1x 6116616
- 1x 6105708
- 1x 6303499
- 1x 4584727
- 1x 6205341
- 1x 6270320
- 1x 6223923
- 1x 6352820
- 1x 6384570
- 1x 6226749
- 1x 6123728
- 1x 6270417
- 1x 6174813
- 1x 6370031
- 1x 6384058
- 1x 6351352
- 1x 6372016
- 1x 6369661
- 1x 6211710
- 6x 302424
- 5x 407024
- 4x 4201587
- 14x 306924



4x
6268959

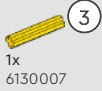

1x
6130007

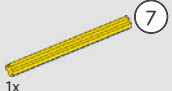

1x
6130009



2x
6170421



2x
6210496



2x
4598897



9x
306226



2x
4529236



7x
6056234



5x
6168646



2x
614126



1x
6270027



4x
6332148



5x
459926



1x
302426



8x
6273589



2x
6172383



9x
6234994



6x
6371584



3x
6173105



1x
6344245



5x
6335317



1x
6349966



2x
6336977



1x
6405102



4x
4177431



8x
6308032



3x
6196548



1x
6330189



2x
4180508



6x
6143850



7x
6279875



4x
6195273



9x
403226



1x
452926



1x
6280097



8x
614326



1x
452826



2x
6349967



1x
4198367



1x
4512363



1x
6268905



2x
6261348



8x
6382697



1x
6178922



1x
6156991



21x
302326



1x
6069000



5x
6092585



1x
6369578



1x
6138173



1x
6184784



3x
6350725



6x
300426



10x
306926



2x
4144024



1x
6248533



1x
6016172



8x
614326



1x
452826



1x
6382249



2x
6288220



2x
4106513



2x
6346535



2x
4140588



1x
6312496



2x
302226



1x
6191630



2x
300326



7x
242026



2x
6089119



4x
6313508



2x
4515368



4x
6272184



5x
362226



1x
362326



1x
6154860



6x
4558170



1x
383526



5x
6305216



1x
300226



1x
6018805



3x
4205760



2x
371026



2x
4162443



10x
6254045



3x
6066113



1x
6387246



1x
6351360



1x
4558957



1x
302026



6x
6350415



2x
6177156



2x
6055070



3x
366626



1x
346026



1x
303226



1x
4100378



5x
6345264



1x
6284697



1x
303226



1x
4100378



7x
6270055



1x
6000071



5x
6238881



1x
6074870



1x
6092586



1x
4107736



12x
4514845



1x
244526



1x
303326

1x
6135287

1x
6171101

4x
300528

1x
6150607

2x
6395137

1x
6385260

1x
4621947

1x
6385261

2x
4621947

7x
6270055

1x
6000071

5x
6238881

1x
6074870

1x
6092586

1x
4107736



2x
302328



3x
6399786



2x
6365611



2x
4125281



37x
6268814



3x
6402701



2x
74040



1x
302128



2x
6226928



1x
371028



1x
6253139



4x
6062166



4x
4106356



1x
6038682



2x
4116671



4x
6403577



5x
6021999



1x
4277361

- 2x 6345559
- 1x 6218146
- 1x 4279059
- 66x 6206150
- 13x 6235080
- 3x 4119479
- 5x 6266964
- 1x 6382577
- 21x 6104342
- 1x 6303099
- 1x 4579659
- 3x 4614158
- 1x 4570877
- 1x 6370297
- 3x 6074892
- 4x 6074893
- 1x 4535928
- 1x 6253418
- 6x 6245250
- 1x 6220959
- 1x 6238673
- 1x 6353237
- 2x 6238046
- 2x 6247364
- 1x 6240515
- 1x 6345402
- 1x 6249417
- 31x 6258951
- 1x 6394674
- 4x 6385281
- 5x 6385280
- 1x 6328445
- 3x 6132767
- 6x 4496699
- 5x 4528604
- 1x 4598955
- 1x 6047415
- 8x 6035540
- 4x 4267874
- 1x 6015424
- 1x 4595712
- 3x 6156492
- 2x 6167894
- 5x 4246957
- 1x 6006524
- 1x 4595709
- 6x 4251796
- 1x 6096215
- 1x 6114515
- 3x 6109751
- 8x 6132768
- 1x 6335769
- 1x 4505985
- 1x 4530129
- 1x 6392974
- 5x 6400754
- 1x 6331221
- 5x 6403580
- 1x 6405994
- 1x 6406106
- 6x 6168645
- 8x 6322997
- 2x 6384234
- 2x 4539090
- 1x 4583299
- 9x 6357747
- 1x 6240227
- 8x 6172233
- 1x 6245265
- 2x 6314353
- 1x 6071608
- 1x 6207256
- 2x 6138731
- 2x 6393668
- 2x 6170468
- 1x 6341968
- 3x 6284586
- 2x 6285623
- 5x 4211183
- 4x 6186673
- 6x 6215659
- 1x 6234347
- 1x 4626196
- 12x 6170813
- 7x 4211288
- 4x 6397610
- 5x 6348057
- 3x 4225469
- 1x 4620075
- 3x 6062574
- 2x 6329114
- 2x 6238874
- 1x 6315053
- 1x 6347749
- 8x 6248944
- 12x 6337003
- 1x 4506003
- 1x 6306775
- 5x 4211159
- 6x 6035291
- 5x 6278989
- 2x 6075213
- 2x 6102360
- 3x 4211166
- 1x 4211180
- 4x 6172757
- 1x 6269006
- 1x 4531751
- 2x 6291040
- 5x 6261359
- 4x 6192310
- 7x 6365885
- 20x 4211150
- 13x 4211151
- 2x 6103004
- 3x 6330202
- 2x 6398342
- 1x 6173132
- 3x 4211149
- 4x 6310449
- 2x 6226436
- 5x 6290983
- 5x 6268960
- 5x 6280160
- 4x 6196221
- 5x 6425510
- 18x 4211257
- 3x 6167644
- 11x 6221608
- 4x 6342958
- 4x 6409552
- 1x 6146301
- 8x 6135494
- 3x 6333110
- 4x 6100769

- 2x 6245259
- 1x 4211201
- 2x 6318734
- 12x 6345639
- 1x 4211807
- 4x 6285778
- 10x 4211387
- 8x 4211396
- 1x 6251470
- 1x 6254220
- 1x 6179636
- 1x 4533101
- 1x 6172636
- 1x 6120224
- 5x 6116613
- 10x 4211189
- 1x 4216668
- 1x 6132732
- 2x 4211279
- 2x 6153594
- 3x 6177697
- 3x 6257604
- 3x 4211194
- 1x 4283660
- 5x 4538252
- 3x 6307618
- 6x 4211186
- 1x 6254220
- 1x 6179636
- 1x 4533101
- 8x 4221590
- 2x 6177998
- 1x 4211193
- 1x 4655611
- 1x 4243838
- 4x 6176608
- 1x 4609635
- 1x 6270119
- 1x 4211247
- 2x 4585337
- 5x 6030812
- 1x 6409901
- 1x 6335631
- 1x 6428495
- 3x 6428486
- 3x 6428489
- 1x 6428491
- 1x 6400203
- 1x 6428493
- 1x 6428494
- 1x 6428496
- 11x 6250597
- 6x 4211399
- 36x 4558953
- 2x 4211415
- 121x 6262085
- 1x 4521921
- 83x 6401023
- 9x 6061702
- 20x 4215513
- 6x 4211535
- 35x 6225242
- 1x 6186013
- 14x 6267495
- 3x 6354568
- 10x 6320297
- 3x 4211541
- 108x 4211398
- 4x 4211414
- 4x 4211437
- 5x 4211440
- 30x 4211564
- 6x 6015344
- 1x 6326078
- 8x 6396791
- 2x 6066097
- 281x 6000066
- 4x 6043656
- 2x 6248492
- 3x 4515374
- 1x 6028813
- 16x 6327412
- 1x 4642934
- 3x 6354568
- 10x 6320297
- 3x 4211541
- 108x 4211398
- 4x 4211414
- 4x 4211437
- 5x 4211440
- 30x 4211564
- 6x 6015344
- 1x 6326078
- 8x 6396791
- 2x 6066097
- 281x 6000066
- 4x 6123809
- 1x 4211494
- 2x 4211614
- 6x 4216248
- 1x 6117967
- 10x 4651063
- 1x 4654582
- 2x 6258820
- 16x 4211461
- 1x 6276874
- 3x 6385183
- 4x 4211397
- 1x 4211413
- 1x 6212077
- 10x 6163990
- 104x 4211349
- 8x 4211353
- 2x 6065824
- 3x 6326478
- 20x 4211436
- 4x 4234535
- 24x 6403579
- 1x 6339298
- 1x 6326483
- 12x 4645397
- 241x 4211428
- 22x 4211429
- 5x 6211969
- 10x 4211488
- 7x 4558169
- 1x 6258831
- 7x 4211525
- 4x 6416524
- 1x 4211718
- 1x 4211356
- 204x 4211394
- 1x 6031056
- 24x 4211435
- 2x 4211441
- 32x 4211445
- 18x 6402876
- 2x 4211636
- 2x 6257593
- 16x 6403585
- 6x 6013497
- 4x 6061675
- 1x 6272132
- 1x 4515351
- 1x 6015347

5

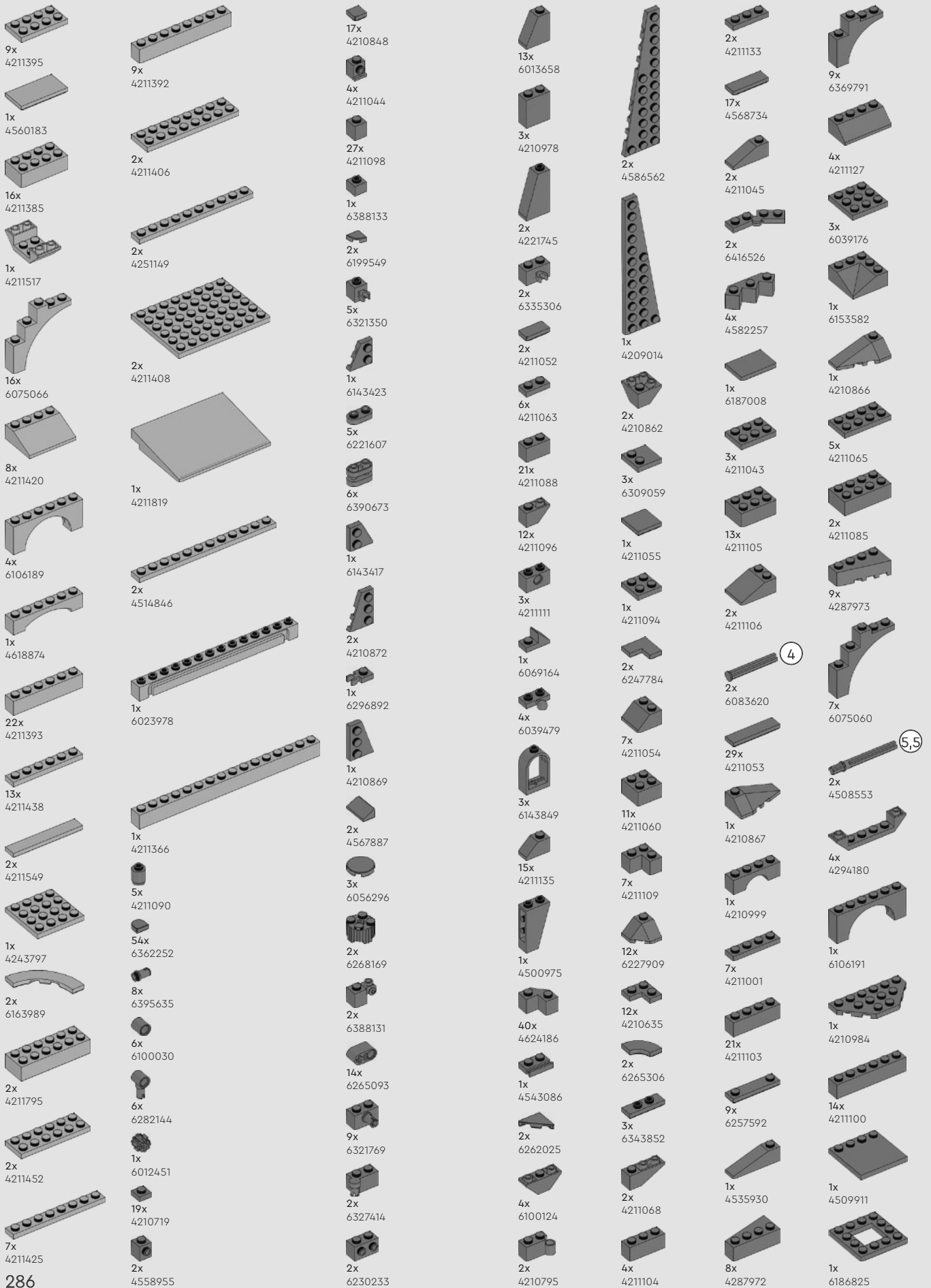

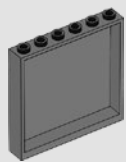

1x
4505068

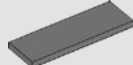

1x
6321746



4x
4210875



2x
4211002



1x
6182451

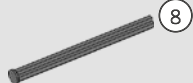

8

2x
4499858

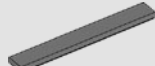

2x
4211008



1x
4210998



5x
4211134



1x
4211107



2x
4211061



1x
4210802



5x
6258887



1x
4256149

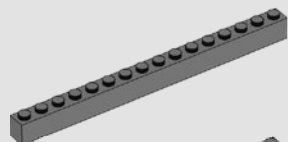

1x
4210783

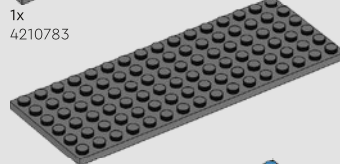

1x
4226358

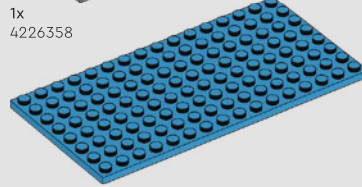

1x
6306028

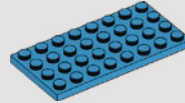

1x
6209672



3x
6411366



1x
6346764



4x
6151659



3x
6137300



1x
6144149



2x
6210675



1x
6164336



4x
6343649



1x
6211361



5x
6355722



2x
6312357



2x
6312357



4x
4611883



1x
6403998



3x
6022105



18x
6315780



1x
6385999



1x
4632767



2x
6332586



1x
6310386



8x
6127366



12x
6272144



1x
4529672



6x
6336664



1x
6005030



1x
6247800



1x
6400315



2x
6284589



5x
6300103



1x
6167641



2x
6057986



10x
6167690



3x
6177146

2x
6296061

1x
6135191

4x
6167700



1x
6314190



10x
6324205



2x
6359941



10x
6021997



4x
6292154



2x
6167642



1x
4569382



4x
6218360



1x
6313599



59x
6372265



13x
6102990



1x
6312464



1x
6292145



1x
6371952



2x
6360055



1x
6317293



1x
6336665



3x
6093494



1x
6268844



7x
6020190



1x
6343854



2x
6102995

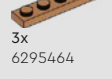

3x
6295464



1x
6196796



4x
6162578



4x
6107389



1x
6363149



1x
6317181



1x
6295400



2x
6363145



1x
6125711



4x
6037507



2x
6403581



2x
6076677



3x
6248874



3x
6404506



2x
6037634



3x
6335666



7x
6209683



4x
6375358



2x
6287612



2x
4505990



2x
6190252



1x
6186672



1x
6173139



1x
6171138



1x
6173109



1x
6245278



1x
6317208



1x
6400204



1x
6138068



1x
6093529



1x
6287672



1x
6147169

Customer Service
 Kundenservice
 Service Client
 Assistenza clienti
 Atención al cliente
 Serviço de Apoio ao Consumidor
 Ügyfélszolgálat
 Klientu apkalpošanas dienests
 Serviciul pentru clienți
 客户服务
 Консьюмер-сервис
 고객 서비스
LEGO.com/service

